

# **Construction Controls:**

- 1.0 Overview of Construction Controls**
- 2.0 Erosion Controls**
- 3.0 Sediment Controls**
- 4.0 Material Waste Controls**

## Table of Contents

<b>1.0 Overview of Construction Controls .....</b>	<b>CC-1</b>
1.1 Introduction .....	CC-1
1.2 Control Selection Guide .....	CC-1
1.2.1 Erosion Controls .....	CC-2
1.2.2 Sediment Controls .....	CC-2
1.2.3 Material and Waste Controls .....	CC-4
1.3 Site Rating Calculation .....	CC-5
1.3.1 Introduction .....	CC-5
1.3.2 Background .....	CC-5
1.3.3 Methodology .....	CC-5
1.3.4 Summary .....	CC-10
<b>2.0 Erosion Controls .....</b>	<b>CC-12</b>
2.1 Check Dam .....	CC-12
2.1.1 Primary Use .....	CC-13
2.1.2 Applications .....	CC-13
2.1.3 Design Criteria .....	CC-13
2.1.4 Design Guidance and Specifications .....	CC-15
2.1.5 Inspection and Maintenance Requirements .....	CC-15
2.1.6 Example Schematics .....	CC-15
2.2 Diversion Dike .....	CC-20
2.2.1 Primary Use .....	CC-21
2.2.2 Applications .....	CC-21
2.2.3 Design Criteria .....	CC-21
2.2.4 Design Guidance and Specifications .....	CC-22
2.2.5 Inspection and Maintenance Requirements .....	CC-22
2.2.6 Example Schematics .....	CC-22
2.3 Erosion Control Blankets .....	CC-25
2.3.1 Primary Use .....	CC-26
2.3.2 Applications .....	CC-26
2.3.3 Design Criteria .....	CC-26
2.3.4 Design Guidance and Specifications .....	CC-27
2.3.5 Inspection and Maintenance Requirements .....	CC-27
2.3.6 Example Schematics .....	CC-27
2.4 Interceptor Swale .....	CC-30

---

2.4.1	Primary Use.....	CC-31
2.4.2	Applications.....	CC-31
2.4.3	Design Criteria.....	CC-31
2.4.4	Design Guidance and Specifications.....	CC-32
2.4.5	Inspection and Maintenance Requirements.....	CC-32
2.4.6	Example Schematics.....	CC-32
2.5	Mulching.....	CC-34
2.5.1	Primary Use.....	CC-35
2.5.2	Applications.....	CC-35
2.5.3	Design Criteria.....	CC-35
2.5.4	Design Guidance and Specifications.....	CC-37
2.5.5	Inspection and Maintenance Requirements.....	CC-38
2.6	Pipe Slope Drain.....	CC-39
2.6.1	Primary Use.....	CC-40
2.6.2	Applications.....	CC-40
2.6.3	Design Criteria.....	CC-40
2.6.4	Design Guidance and Specifications.....	CC-41
2.6.5	Inspection and Maintenance Requirements.....	CC-41
2.6.6	Example Schematics.....	CC-41
2.7	Soil Surface Treatments.....	CC-43
2.7.1	Primary Use.....	CC-44
2.7.2	Applications.....	CC-44
2.7.3	Design Criteria.....	CC-44
2.7.4	Design Guidance and Specifications.....	CC-47
2.7.5	Inspection and Maintenance Requirements.....	CC-47
2.8	Turf Reinforcement Mats.....	CC-48
2.8.1	Primary Use.....	CC-49
2.8.2	Applications.....	CC-49
2.8.3	Design Criteria.....	CC-49
2.8.4	Design Guidance and Specifications.....	CC-50
2.8.5	Inspection and Maintenance Requirements.....	CC-50
2.8.6	Example Schematics.....	CC-50
2.9	Vegetation.....	CC-53
2.9.1	Primary Use.....	CC-54
2.9.2	Applications.....	CC-54
2.9.3	Design Criteria.....	CC-54

2.9.4	Design Guidance and Specifications .....	CC-58
2.9.5	Inspection and Maintenance Requirements .....	CC-58
2.10	Velocity Dissipation Devices .....	CC-60
2.10.1	Primary Use .....	CC-61
2.10.2	Applications .....	CC-61
2.10.3	Design Criteria .....	CC-61
2.10.4	Design Guidance and Specifications .....	CC-62
2.10.5	Inspection and Maintenance Requirements .....	CC-62
2.10.6	Example Schematics .....	CC-62
<b>3.0</b>	<b>Sediment Controls .....</b>	<b>CC-64</b>
3.1	Active Treatment System (ATS) .....	CC-64
3.1.1	Primary Use .....	CC-65
3.1.2	Applications .....	CC-65
3.1.3	Design Criteria .....	CC-65
3.1.4	Design Guidance and Specifications .....	CC-68
3.1.5	Inspection and Maintenance Requirements .....	CC-68
3.1.6	Example Schematics .....	CC-68
3.2	Depressed Grade (Curb Cut-Back) Sediment Trap .....	CC-70
3.2.1	Primary Use .....	CC-71
3.2.2	Applications .....	CC-71
3.2.3	Design Criteria .....	CC-71
3.2.4	Design Guidance and Specifications .....	CC-71
3.2.5	Inspection and Maintenance Requirements .....	CC-71
3.2.6	Example Schematics .....	CC-71
3.3	Dewatering Controls .....	CC-75
3.3.1	Primary Use .....	CC-76
3.3.2	Applications .....	CC-76
3.3.3	Design Criteria .....	CC-76
3.3.4	Design Guidance and Specifications .....	CC-78
3.3.5	Inspection and Maintenance Requirements .....	CC-78
3.3.6	Example Schematics .....	CC-79
3.4	Inlet Protection .....	CC-81
3.4.1	Primary Use .....	CC-82
3.4.2	Applications .....	CC-82
3.4.3	Design Criteria .....	CC-82
3.4.4	Design Guidance and Specifications .....	CC-86

3.4.5	Inspection and Maintenance Requirements.....	CC-86
3.4.6	Example Schematics.....	CC-86
3.5	Organic Filter Berm.....	CC-96
3.5.1	Primary Use.....	CC-97
3.5.2	Applications.....	CC-97
3.5.3	Design Criteria.....	CC-97
3.5.4	Design Guidance and Specifications.....	CC-97
3.5.5	Inspection and Maintenance Requirements.....	CC-97
3.5.6	Example Schematics.....	CC-98
3.6	Organic Filter Tubes.....	CC-100
3.6.1	Primary Use.....	CC-101
3.6.2	Applications.....	CC-101
3.6.3	Design Criteria.....	CC-101
3.6.4	Design Guidance and Specifications.....	CC-103
3.6.5	Inspection and Maintenance Requirements.....	CC-103
3.6.6	Example Schematics.....	CC-103
3.7	Passive Treatment System (PTS).....	CC-106
3.7.1	Primary Use.....	CC-107
3.7.2	Applications.....	CC-107
3.7.3	Design Criteria.....	CC-107
3.7.4	Design Guidance and Specifications.....	CC-109
3.7.5	Inspection and Maintenance Requirements.....	CC-109
3.8	Pipe Inlet Sediment Trap.....	CC-110
3.8.1	Primary Use.....	CC-111
3.8.2	Applications.....	CC-111
3.8.3	Design Criteria.....	CC-111
3.8.4	Design Guidance and Specifications.....	CC-112
3.8.5	Inspection and Maintenance Requirements.....	CC-112
3.8.6	Example Schematics.....	CC-112
3.9	Sediment Basin.....	CC-115
3.9.1	Primary Use.....	CC-116
3.9.2	Applications.....	CC-116
3.9.3	Design Criteria.....	CC-116
3.9.4	Design Guidance and Specifications.....	CC-119
3.9.5	Inspection and Maintenance Requirements.....	CC-120
3.9.6	Example Schematics.....	CC-120

---

3.9.7	Design Procedures .....	CC-125
3.9.8	Design Form .....	CC-140
3.10	Silt Fence .....	CC-143
3.10.1	Primary Use .....	CC-144
3.10.2	Applications .....	CC-144
3.10.3	Design Criteria .....	CC-144
3.10.4	Design Guidance and Specifications .....	CC-145
3.10.5	Inspection and Maintenance Requirements .....	CC-145
3.10.6	Example Schematics .....	CC-146
3.11	Stabilized Construction Exit .....	CC-148
3.11.1	Primary Use .....	CC-149
3.11.2	Applications .....	CC-149
3.11.3	Design Criteria .....	CC-149
3.11.4	Design Guidance and Specifications .....	CC-150
3.11.5	Inspection and Maintenance Requirements .....	CC-150
3.11.6	Example Schematics .....	CC-150
3.12	Stone Outlet Sediment Trap .....	CC-152
3.12.1	Primary Use .....	CC-153
3.12.2	Applications .....	CC-153
3.12.3	Design Criteria .....	CC-153
3.12.4	Design Guidance and Specifications .....	CC-154
3.12.5	Inspection and Maintenance Requirements .....	CC-154
3.12.6	Example Schematics .....	CC-154
3.13	Triangular Sediment Filter Dike .....	CC-157
3.13.1	Primary Use .....	CC-158
3.13.2	Applications .....	CC-158
3.13.3	Design Criteria .....	CC-158
3.13.4	Design Guidance and Specifications .....	CC-159
3.13.5	Inspection and Maintenance Requirements .....	CC-159
3.13.6	Example Schematics .....	CC-159
3.14	Turbidity Barrier .....	CC-161
3.14.1	Primary Use .....	CC-162
3.14.2	Applications .....	CC-162
3.14.3	Design Criteria .....	CC-162
3.14.4	Design Guidance and Specifications .....	CC-163
3.14.5	Inspection and Maintenance Requirements .....	CC-163

3.14.6	Example Schematics.....	CC-163
3.15	Vegetated Filter Strips and Buffers.....	CC-166
3.15.1	Primary Use.....	CC-167
3.15.2	Applications.....	CC-167
3.15.3	Design Criteria.....	CC-167
3.15.4	Design Guidance and Specifications.....	CC-169
3.15.5	Inspection and Maintenance Requirements.....	CC-169
3.15.6	Example Schematics.....	CC-169
3.16	Wheel Cleaning Systems.....	CC-171
3.16.1	Primary Use.....	CC-172
3.16.2	Applications.....	CC-172
3.16.3	Design Criteria.....	CC-172
3.16.4	Design Guidance and Specifications.....	CC-173
3.16.5	Inspection and Maintenance Requirements.....	CC-174
3.16.6	Example Schematics.....	CC-174
<b>4.0</b>	<b>Material and Waste Controls.....</b>	<b>CC-178</b>
4.1	Chemical Management.....	CC-178
4.1.1	Primary Use.....	CC-179
4.1.2	Applications.....	CC-179
4.1.3	Design Criteria.....	CC-179
4.1.4	Design Guidance and Specifications.....	CC-181
4.1.5	Inspection and Maintenance Requirements.....	CC-182
4.2	Concrete Sawcutting Waste Management.....	CC-183
4.2.1	Primary Use.....	CC-184
4.2.2	Applications.....	CC-184
4.2.3	Design Criteria.....	CC-184
4.2.4	Design Guidance and Specifications.....	CC-185
4.2.5	Inspection and Maintenance Requirements.....	CC-185
4.3	Concrete Waste Management.....	CC-186
4.3.1	Primary Use.....	CC-187
4.3.2	Applications.....	CC-187
4.3.3	Design Criteria.....	CC-187
4.3.4	Design Guidance and Specifications.....	CC-189
4.3.5	Inspection and Maintenance Requirements.....	CC-189
4.3.6	Example Schematics.....	CC-189
4.4	Debris and Trash Management.....	CC-191

4.4.1	Primary Use.....	CC-192
4.4.2	Applications .....	CC-192
4.4.3	Design Criteria.....	CC-192
4.4.4	Design Guidance and Specifications .....	CC-194
4.4.5	Inspection and Maintenance Requirements.....	CC-194
4.5	Hyper-Chlorinated Water Management.....	CC-195
4.5.1	Primary Use.....	CC-196
4.5.2	Applications .....	CC-196
4.5.3	Design Criteria.....	CC-196
4.5.4	Design Guidance and Specifications .....	CC-198
4.5.5	Inspection and Maintenance Requirements.....	CC-198
4.6	Sandblasting Waste Management.....	CC-199
4.6.1	Primary Use.....	CC-200
4.6.2	Applications .....	CC-200
4.6.3	Design Criteria.....	CC-200
4.6.4	Design Guidance and Specifications .....	CC-201
4.6.5	Inspection and Maintenance Requirements.....	CC-201
4.7	Sanitary Waste Management .....	CC-202
4.7.1	Primary Use.....	CC-203
4.7.2	Applications .....	CC-203
4.7.3	Design Criteria.....	CC-203
4.7.4	Design Guidance and Specifications .....	CC-203
4.7.5	Inspection and Maintenance Requirements.....	CC-203
4.8	Spill and Leak Response Procedures .....	CC-204
4.8.1	Primary Use.....	CC-205
4.8.2	Applications .....	CC-205
4.8.3	Design Criteria.....	CC-205
4.8.4	Design Guidance and Specifications .....	CC-206
4.8.5	Inspection and Maintenance Requirements.....	CC-206
4.9	Subgrade Stabilization Management.....	CC-207
4.9.1	Primary Use.....	CC-208
4.9.2	Applications .....	CC-208
4.9.3	Design Criteria.....	CC-208
4.9.4	Design Guidance and Specifications .....	CC-208
4.9.5	Inspection and Maintenance Requirements.....	CC-209
4.9.6	Example Schematic.....	CC-209



4.10	Vehicle and Equipment Management.....	CC-210
4.10.1	Primary Use.....	CC-211
4.10.2	Applications.....	CC-211
4.10.3	Design Criteria.....	CC-211
4.10.4	Design Guidance and Specifications.....	CC-212
4.10.5	Inspection and Maintenance Requirements.....	CC-213

## List of Tables

Table 1.1	Erosion Controls.....	CC-2
Table 1.2	Sediment Controls.....	CC-3
Table 1.3	Material and Waste Controls.....	CC-4
Table 1.4	Soil Erodibility Factors (K).....	CC-7
Table 1.5	Length/Slope Factor (LS).....	CC-8
Table 1.6	Cropping Factors.....	CC-9
Table 2.1	Mulch Standards and Guidelines.....	CC-36
Table 2.2	Pipe Slope Drain Minimum Diameters.....	CC-41
Table 2.3	NRCS Wind Erodibility Groups.....	CC-44
Table 2.4	Recommended Grass Mixture for Temporary Erosion Control.....	CC-56
Table 2.5	Recommended Grass Mixture for Final Stabilization of Upland in Rural Areas.....	CC-57
Table 2.6	Recommended Grass Mixture for Final Stabilization of Upland in Urban Areas.....	CC-57
Table 3.1	Perimeter Control Applications.....	CC-102
Table 3.2	Maximum Spacing for Slope Protection.....	CC-102
Table 3.3	Sediment Basin Effectiveness for Different Soil Types.....	CC-116
Table 3.4	Number and Spacing of Anti-Seep Collars.....	CC-119
Table 3.5	Pipe Flow Chart, n=0.013.....	CC-130
Table 3.6	Pipe Flow Chart, n=0.025.....	CC-131
Table 3.7	Design Data for Earth Spillways.....	CC-133
Table 3.8	Trash Rack and Anti-Vortex Device Design Table.....	CC-138
Table 3.9	Minimum Exit Dimensions.....	CC-150
Table 3.10	Sizing of Vegetated Buffers and Strips.....	CC-168
Table 4.1	Chemical Dechlorination Agents and Approximate Dosages.....	CC-197

## List of Figures

Figure 2.1	Schematics of Rock Check Dams.....	CC-16
Figure 2.2	Schematics of Rock Bag Check Dams.....	CC-17
Figure 2.3	Schematics of Sack Gabion Check Dams.....	CC-18

Figure 2.4	Schematics of Organic Filter Tube Check Dams .....	CC-19
Figure 2.5	Schematics of Diversion Dike .....	CC-23
Figure 2.6	Schematics of Diversion Dike with Swale .....	CC-24
Figure 2.7	Schematics of Erosion Control Blankets .....	CC-28
Figure 2.8	Anchor Examples for Erosion Control Blankets .....	CC-29
Figure 2.9	Schematics of Interceptor Swale .....	CC-33
Figure 2.10	Schematics of Pipe Slope Drain .....	CC-42
Figure 2.11	Schematics of Turf Reinforcement Mats .....	CC-51
Figure 2.12	Examples of Turf Reinforcement Mat Anchoring .....	CC-52
Figure 2.13	Schematics of Velocity Dissipation Device .....	CC-63
Figure 3.1	Schematics of Active Treatment System .....	CC-69
Figure 3.2	Schematics of Depressed Grade (Curb Cut-Back) Sediment Trap .....	CC-73
Figure 3.3	Schematics of Depressed Pavement Replacement Sediment Trap .....	CC-74
Figure 3.4	Schematics of Dewatering Controls .....	CC-80
Figure 3.5	Schematics of 2"x4" Weir Curb Inlet Protection .....	CC-87
Figure 3.6	Schematics of Organic Filter Tube Curb Inlet Protection .....	CC-88
Figure 3.7	Schematics of Hog Wire Weir Curb Inlet Protection .....	CC-89
Figure 3.8	Schematics of Block and Gravel Filter Curb Inlet Protection .....	CC-90
Figure 3.9	Schematic of Organic Filter Tube On-Grade Curb Inlet Protection .....	CC-91
Figure 3.10	Schematics of Filter Fabric Area Inlet Protection .....	CC-92
Figure 3.11	Schematics of Excavated Impoundment Area Inlet Protection .....	CC-93
Figure 3.12	Schematics of Block and Gravel Area Inlet Protection .....	CC-94
Figure 3.13	Schematics of Organic Filter Tube Area Inlet Protection .....	CC-95
Figure 3.14	Schematics of Organic Filter Berm .....	CC-99
Figure 3.15	Schematics of Organic Filter Tubes .....	CC-104
Figure 3.16	Examples of Organic Filter Tube Installation Methods .....	CC-105
Figure 3.17	Schematics of Type A Pipe Inlet Sediment Trap .....	CC-113
Figure 3.18	Schematics of Type B Pipe Inlet Sediment Trap .....	CC-114
Figure 3.19	Schematics of Sediment Basin with Surface Skimmer .....	CC-121
Figure 3.20	Schematics of Sediment Basin with Overflow Riser .....	CC-122
Figure 3.21	Schematics of Basin Embankment with Flashboard Riser .....	CC-123
Figure 3.22	Schematic of Basin Embankment with Perforated Riser .....	CC-124
Figure 3.23	Example of Basin Outlet Design .....	CC-128
Figure 3.24	Riser Inflow Curves for Basin Outlet Design .....	CC-129
Figure 3.25	Example of Excavated Earth Spillway Design .....	CC-132
Figure 3.26	Example of Anti-Vortex Design for Corrugated Metal Pipe Riser .....	CC-137
Figure 3.27	Riser Pipe Base Design for Embankment Less Than 10 Feet High .....	CC-139
Figure 3.28	Schematics of Silt Fence .....	CC-147
Figure 3.29	Schematics of Stabilized Construction Exit .....	CC-151

---

Figure 3.30	Schematics of Excavated Stone Outlet Sediment Trap.....	CC-155
Figure 3.31	Schematics of Bermed Stone Outlet Sediment Trap.....	CC-156
Figure 3.32	Schematics of Triangular Sediment Filter Dike.....	CC-160
Figure 3.33	Example Application of Turbidity Barrier.....	CC-164
Figure 3.34	Schematics of Turbidity Barrier.....	CC-165
Figure 3.35	Schematics of Vegetated Filter Strip.....	CC-170
Figure 3.36	Schematics of Rumble Rack Wheel Cleaning.....	CC-175
Figure 3.37	Schematics of Corrugated Metal Wheel Wash.....	CC-176
Figure 3.38	Schematics of Flooded Basin Wheel Wash.....	CC-177
Figure 4.1	Schematics of Concrete Washout Containment.....	CC-190
Figure 4.2	Schematic of Controls for Subgrade Stabilization.....	CC-209

# 1.0 Overview of Construction Controls

## 1.1 Introduction

In order to address the requirements of pollution reduction at construction sites, a variety of controls should be employed to reduce soil erosion, reduce sediment loss from the site, and manage construction-generated waste and construction related toxic materials. Controls consist of both temporary and permanent methods to reduce pollution from a construction site.

The majority of controls address loss of soil from the site. Soil loss in the form of erosion and sediment due to storm events and wind constitute the majority of pollution generated from construction sites. Controls that address erosion and sediment are typically more site specific than waste and toxics management. Erosion and sediment controls are dependent on site slopes, drainage patterns and drainage quantities along with other site-specific conditions. Materials and waste management consists primarily of “good housekeeping” practices which are dependent on the type of construction and the quantity and type of building materials.

## 1.2 Control Selection Guide

The designer preparing the iSWM Construction Plan can first use the control selection guide on the following pages to determine the controls that are most appropriate for the site. Chapters 2.0, 3.0 and 4.0 contain the descriptions, design requirements, maintenance requirements, and limitations of the controls. These provide the tools for the designer to select the appropriate controls and properly locate them on the site, to effectively reduce erosion and sediment loss.

The Efficiency Ratings listed for the controls are the range of average efficiencies in reducing erosion or trapping sediment for the control, assuming the controls are properly designed, installed, and maintained for the flow and volumes from the design storm. The removal efficiency varies within in the range based on soil type.

The Efficiency Ratings are useful in comparing the effectiveness of the controls. The ratings are also used in calculating the Site Rating, which is used by some municipalities to ensure adequate design of erosion and sediment controls. Refer to [Section 1.3 Site Rating Calculations](#) for additional details concerning the Efficiency Ratings and the methodology for calculating the Site Rating.

The following legend applies to the Targeted Pollutants and Implementation Considerations presented for each of the controls:

Legend	
●	Significant Impact
◐	Medium Impact
○	Low Impact
?	Unknown or Questionable Impact

### 1.2.1 Erosion Controls

These controls are the measures and techniques used to retain soil in place. They are installed on the perimeter of the site to limit flow across disturbed areas and within the site to provide protective covering of disturbed areas that are not actively being worked. Erosion controls reduce the amount of soil removed and transported by stormwater runoff and reduce the need for sediment controls.

<b>Control</b>	<b>Primary Purpose</b>	<b>Efficiency Rating (Fe)</b>
<b>Check Dam</b>	Slow flow to prevent erosion of swales and drainage ditches while also providing minor detention and sediment removal	0.30 - 0.50 <i>(Depends on soil type)</i>
<b>Diversion Dike</b>	Route flows around slopes and disturbed areas	0.95
<b>Erosion Control Blankets</b>	Protect disturbed soil and slopes from erosion using a degradable, rolled erosion control product; also provides limited protection as a perimeter control	0.90 <i>(Ground cover)</i> 0.65 <i>(Perimeter w/o vegetation)</i>
<b>Interceptor Swale</b>	Route flows around slopes and disturbed areas	0.95
<b>Mulching</b>	Protect disturbed soil with a layer of straw, wood chips, compost or other organic material	0.75 - 0.90 <i>(Depends on coverage)</i>
<b>Pipe Slope Drain</b>	Route overland flow on a slope into a pipe to protect the slope	0.95
<b>Soil Surface Treatments</b>	Protect disturbed soil from wind erosion (dust control) while also providing some protection from water erosion, depending on the treatment method	0.10 - 0.90 <i>(Depends on type of treatment)</i>
<b>Turf Reinforcement Mats</b>	Protect disturbed soil on steep slopes and in channels from erosion using a non-degradable, rolled erosion control product	0.90
<b>Vegetation</b>	Prevent erosion by providing a natural cover through hydro-mulching, seeding or sod placement	0.90 <i>(When fully established; lower while vegetation is first growing)</i>
<b>Velocity Dissipation Devices</b>	Protect soil from erosion at points where concentrated flows are discharged	N/A

The Efficiency Ratings listed for the erosion controls are the assumed average efficiencies in reducing erosion, based on the controls being designed for the flow and volume from the temporary control design storm and installed in accordance with the criteria in this manual.

### 1.2.2 Sediment Controls

These controls are temporary structures or devices that capture soil transported by stormwater through sedimentation, filtration or chemical treatment of the runoff. They are used to trap sediment before it leaves the construction site. The effectiveness of controls that form a barrier or filter for trapping soil is highly dependent on the size of soil particles. The efficiencies presented are **ranges based on soil types**. The removal efficiency will be at the high end of the range for sand and coarse silt or loam and at the low end for fine silt or loam and clay. Controls with a single number for the efficiency rating do not vary in performance based on soil type.

<b>Control</b>	<b>Primary Purpose</b>	<b>Efficiency Rating (Fe)</b>
<b>Active Treatment System</b>	Remove pollutants and suspended soil, including fine clay particles, through filtration and/or chemical-aided flocculation	0.99
<b>Depressed Grade Sediment Trap</b>	Detain and settle suspended soil from small areas within rights-of-way	0.50 - 0.75
<b>Dewatering Controls</b>	Remove suspended soil from water that is pumped out of low points onsite	0.50 - 0.75
<b>Inlet Protection</b>	Intercept sediment at curb and area inlets as a secondary defense in sequence with other controls	0.35 - 0.65
<b>Organic Filter Berm</b>	Slow and filter runoff to retain sediment	0.50 - 0.75
<b>Organic Filter Tubes</b>	Slow and filter runoff to retain sediment	0.50 - 0.75
<b>Passive Treatment System</b>	Improve performance of other controls by adding flocculation agents to stormwater	0.85
<b>Pipe Inlet Protection</b>	Detain stormwater for sedimentation and filtration before it enters a closed conveyance system	0.50 - 0.75
<b>Sediment Basin</b>	Detain stormwater in a pond with a controlled outflow to allow for sedimentation	0.50 - 0.90
<b>Silt Fence</b>	Slow and filter runoff to retain sediment	0.50 - 0.75
<b>Stabilized Construction Exit</b>	Reduce offsite sediment tracking from trucks and construction equipment	N/A
<b>Stone Outlet Sediment Trap</b>	Intercept and filter small, concentrated flows in swales and other defined waterways	0.50 - 0.85
<b>Triangular Sediment Filter Dike</b>	Slow and filter runoff to retain sediment	0.50 - 0.75
<b>Turbidity Barrier</b>	Detain and settle suspended soil where work is occurring in or adjacent to a water body	0.50 - 0.90
<b>Vegetated Filter Strips and Buffers</b>	Slow sheet flow from small areas to allow for sedimentation	0.35 – 0.85 <i>(Depends on many conditions in addition to soil type)</i>
<b>Wheel Cleaning Systems</b>	Reduce offsite sediment tracking from trucks and construction equipment	N/A

The Efficiency Ratings listed for the sediment controls are the assumed average efficiencies in capturing sediment for a range of soil types, based on the controls being designed for the flow and volume from the temporary control design storm and installed in accordance with the criteria in this manual.

### 1.2.3 *Material and Waste Controls*

Material and waste control techniques are applicable on the majority of construction projects due to their general purpose of reducing the discharge of pollutants from construction activities. They form the basis of good housekeeping procedures that should be followed during construction and in many cases are mandated by stormwater discharge permits. The techniques are essential to preventing the discharge of pollutants other than sediment from a construction site.

A numeric efficiency rating is not provided for material and waste controls, since the controls are not for erosion and sediment and are not a factor in the Site Rating calculation. All of these techniques are highly effective in minimizing discharges of the targeted pollutants when properly applied.

<b>Control</b>	<b>Primary Purpose</b>
<b>Chemical Management</b>	Techniques to minimize the exposure of paints, solvents, fertilizer, pesticides, herbicides, and other chemicals to precipitation and stormwater; and techniques for managing the wastewater from washout of paint, form release oils, curing compounds, and other construction chemicals
<b>Concrete Sawcutting Waste Management</b>	Techniques for collection and disposal of the slurry of cutting water and concrete cuttings that results from concrete sawing
<b>Concrete Waste Management</b>	Techniques for disposal of concrete washout, demolished concrete, etc.
<b>Debris and Trash Management</b>	Techniques for storage and disposal of packaging, scrap building materials, personal trash, and other wastes generated by construction activities and personnel
<b>Hyper-Chlorinated Water Management</b>	Techniques to prevent water with high concentrations of chlorine from being discharged
<b>Sandblasting Waste Management</b>	Techniques for disposal of sandblasting waste and containment of wastes during operations
<b>Sanitary Waste Management</b>	Techniques to control and prevent the exposure of sanitary waste to precipitation and stormwater
<b>Spill and Leak Response Procedures</b>	Techniques to minimize the discharge of pollutants from spills and leaks
<b>Subgrade Stabilization Management</b>	Techniques to control runoff from soil being chemically stabilized in preparation for construction
<b>Vehicle and Equipment Management</b>	Techniques to prevent discharges of fluids used in vehicle and equipment operation and maintenance and the discharge of wash waters that contain soaps or solvents

## 1.3 Site Rating Calculation

### 1.3.1 Introduction

The site rating calculation is a useful tool for evaluating the potential effectiveness of proposed erosion and sediment controls on a construction site. It is used to compare the potential soil loss from a site without controls to the soil loss from the site with proposed controls. The site rating may also be used to compare the effectiveness of two different controls on a site.

The site rating calculation is an optional element for an iSWM Construction Plan but may be required by some municipalities in North Central Texas. When required, a numeric site rating is established as the criteria for the design of erosion and sediment controls for a construction site. Municipalities that use the site rating will typically require a minimum site rating of 0.70, which reflects a realistic, attainable reduction in sediment loss from a construction site of 70 percent using controls compared to the same site without the use of controls.

The user of this manual is advised to confirm local requirements with the municipality where the project is located. When required to provide the site rating by the local government, the iSWM Construction Plan should be prepared as described in Chapter 4 of the iSWM Criteria Manual, followed by calculation of the site rating. Controls shall then be modified and added as needed to achieve the minimum required site rating.

### 1.3.2 Background

The design and implementation of erosion and sediment controls is highly dependent on project site conditions and construction methods. The amount of potential soil loss from a site is based on the physical features and location of the site: soil type(s), slope, length of stormwater flow across the site, the rainfall intensity and overall runoff quantity of a particular storm, and the groundcover of the site. Of these factors, construction activity at a site can affect the groundcover, the slope of the site and the length of stormwater flow across the site. These effects are mitigated by minimizing onsite disturbance of the soil and groundcover and providing structural measures to retain sediment onsite after erosion occurs.

The most effective method to reduce sediment loss from a tract of land is to prevent the occurrence of erosion. While structural barriers, such as those shown in this manual, have a theoretical 70 to 90 percent effectiveness rating for removal of sediment from runoff, natural groundcover and mulching can provide up to 98 percent reduction in erosion and site soil loss. Therefore, the primary goals of the erosion control plan for a construction site is to prevent the soil from eroding and to minimize the area of disturbance through the phasing of construction activities, mulching of disturbed but inactive areas, and providing tarps, seeding or hydromulching of stockpiles. These techniques are not only the most effective at reducing soil loss; they are normally the most cost effective due to low initial cost and reduced maintenance requirements.

Sediment removal controls provide the second line of defense by treating sediment-laden stormwater before it is discharged from the site. All construction activities will require areas in which soil is disturbed. Stormwater runoff that crosses areas of exposed soil will require treatment by adequate Best Management Practices in accordance with the guidelines presented in this manual. Sediment removal controls include diversion of stormwater around areas of construction, and filtration and sedimentation (detention) of sediment-laden runoff that crosses disturbed areas.

### 1.3.3 Methodology

#### Site Rating Description

The runoff across both disturbed and non-disturbed areas of a drainage basin produces a quantity of soil loss due to erosion. This quantity is estimated through the use of the Universal Soil Loss Equation as a



mass per time period. Erosion and sediment controls are used to reduce the sediment transported offsite.

The site rating is defined as the theoretical amount of soil that remains uneroded and/or is captured on a site through the use of erosion and sediment controls (soil retained) divided by the theoretical amount of soil that would leave the site if no controls were used (uncontrolled). A minimum site rating of 0.70 is typically used as a guideline for the adequate design of erosion and sediment control systems.

This **site rating** is calculated as follows:

$$SR = ZA_{\text{retained}} / ZA_{\text{uncontrolled}} \quad (1.1)$$

where:

SR = Site Rating

$ZA_{\text{retained}}$  = Soil uneroded and/or retained onsite by erosion prevention and sediment trapping practices (pounds/year)

$ZA_{\text{uncontrolled}}$  = Soil loss from site if no controls used (pounds/year)

**Note that the site rating calculation methodology assumes that the erosion and sediment control measures are correctly designed, installed, and maintained in accordance with the criteria in this manual to treat the volume of runoff from the 2-year, 24-hour storm event, which is the regionally defined design storm frequency for temporary control design.**

### Universal Soil Loss Equation

Several elements are involved in evaluating the potential for erosion of a site. Soil type, length of flow across the ground, slope of ground, rainfall intensity and groundcover play important roles in determining if a site will produce excessive siltation downstream. The Universal Soil Loss Equation is used to determine the potential erodibility of a site. The Universal Soil Loss Equation (USLE) is expressed as:

$$Z = R * K * LS * C_s * P \quad (1.2)$$

where:

Z = Rate of soil loss (tons per acre per year)

R = Rainfall erosion factor (300 for North Texas)

K = Soil erodibility factor

LS = Length/slope factor

$C_s$  = Cropping/management factor

P = Erosion control practice

Calculate the anticipated yearly soil loss (ZA)

$$ZA = Z * A \quad (1.3)$$

where

ZA = Soil loss per year (tons per year)

Z = Rate of soil loss for a drainage basin (tons per acre per year)

A = Area of drainage basin (acres)

Some of the factors above (R and K) remain constant throughout the construction of the project. Both the LS and  $C_s$  factors are altered during construction through clearing, grading and drainage operations on the site. The P factor represents the implementation of erosion and sediment controls to reduce the potential for sediment to be transported offsite. These factors are discussed in the following sections.

### Rainfall Erosion Factor

The average annual rainfall erosion factor, R, varies for different regions throughout the country and during the year. This value accounts for the volume and intensity of rainfall for a one year time period in a region. A value of 300 is used for R in the North Central Texas area.

## Soil Erodibility Factor

The soil erodibility factor, K, indicates the potential for water erosion of the soil. It is strongly suggested that soil erodibility be determined as part of the geotechnical investigation of the site in order to determine the most effective means to reduce site erosion. If a site has not been previously disturbed, the native soil type(s) most likely to be present at the site can be identified on the NRCS Web Soil Survey at: <http://websoilsurvey.nrcs.gov/app/>. The website also contains the soil erodibility factors for native soils.

Consider the depth of grading activities when determining the soil erodibility factor. Soil type varies with depth. The surface soil may have a low erodibility factor, but the soil at a lower depth may have a high erodibility factor when it is exposed by grading operations.

Table 1.4 provides approximate values of K for various soil types and can be used in calculations if detailed data are not available.

<b>Soil Type</b>	<b>K</b>
Sand	0.03
Fine Sand	0.14
Loamy Sand	0.10
Sandy Loam	0.24
Loam	0.34
Silt Loam	0.42
Silt	0.52
Sandy Clay Loam	0.25
Clay Loam	0.25
Silty Clay Loam	0.32
Sandy Clay	0.13
Silty Clay	0.23
Clay	0.13 – 0.29

(Source: Standard Handbook of Environmental Engineering edited by Robert A. Corbitt)

\*Assuming 2% organic matter content.

## Length/Slope Factor

The length-slope factor, LS, of the drainage basin may be changed through construction operations. A reduction in slope or drainage length can significantly reduce the erosion potential of the drainage basin. The length-slope factor considers the topographic features of the drainage basin. The LS factor is defined by the length and slope that a drop of water will travel through the drainage basin from the farthest reach to the point of analysis. The slope value is the average slope of this path. Table 1.5 lists values of LS for a wide variety of slope and drainage length. LS can also be calculated as follows:

$$LS = [L/72.6]^M * [65.41 * \sin^2(S) + 4.56 * \sin(S) + 0.065] \quad (1.4)$$

where:

- L = Length of flow path of contributing area (feet)
- M =  $0.6 * [1 - \exp(-35.835*s)]$  where s=slope (feet/feet)
- S = Average slope of contributing area (degrees)

<b>Length (ft.)</b>	<b>Slope (ft/ft)</b>												
	<b>0.005</b>	<b>0.01</b>	<b>0.015</b>	<b>0.02</b>	<b>0.025</b>	<b>0.03</b>	<b>0.04</b>	<b>0.05</b>	<b>0.06</b>	<b>0.1</b>	<b>0.15</b>	<b>0.2</b>	<b>0.3</b>
10	0.07	0.08	0.09	0.10	0.11	0.12	0.14	0.17	0.20	0.37	0.67	1.06	2.06
20	0.08	0.09	0.11	0.12	0.14	0.16	0.20	0.24	0.29	0.55	1.01	1.60	3.13
30	0.08	0.10	0.12	0.14	0.16	0.18	0.23	0.29	0.36	0.70	1.29	2.05	3.99
40	0.08	0.11	0.13	0.15	0.18	0.21	0.27	0.34	0.42	0.82	1.53	2.43	4.74
50	0.09	0.11	0.13	0.16	0.19	0.22	0.30	0.38	0.47	0.94	1.75	2.78	5.42
60	0.09	0.11	0.14	0.17	0.21	0.24	0.32	0.41	0.52	1.04	1.95	3.10	6.04
70	0.09	0.12	0.15	0.18	0.22	0.26	0.35	0.45	0.56	1.14	2.13	3.40	6.63
80	0.09	0.12	0.15	0.19	0.23	0.27	0.37	0.48	0.60	1.23	2.31	3.68	7.18
90	0.09	0.12	0.16	0.19	0.24	0.28	0.39	0.51	0.64	1.32	2.48	3.95	7.71
100	0.09	0.12	0.16	0.20	0.25	0.30	0.41	0.53	0.68	1.41	2.64	4.21	8.21
125	0.09	0.13	0.17	0.22	0.27	0.32	0.45	0.60	0.76	1.60	3.02	4.81	9.39
150	0.10	0.13	0.18	0.23	0.28	0.35	0.49	0.66	0.84	1.78	3.36	5.37	10.47
175	0.10	0.14	0.18	0.24	0.30	0.37	0.53	0.71	0.91	1.95	3.69	5.89	11.49
200	0.10	0.14	0.19	0.25	0.32	0.39	0.56	0.76	0.98	2.11	3.99	6.38	12.45
250	0.10	0.15	0.20	0.27	0.34	0.42	0.62	0.85	1.10	2.40	4.56	7.29	14.23
300	0.10	0.15	0.21	0.28	0.36	0.46	0.67	0.93	1.22	2.67	5.09	8.14	15.87
350	0.10	0.16	0.22	0.30	0.38	0.49	0.72	1.00	1.32	2.92	5.58	8.92	17.41
400	0.11	0.16	0.23	0.31	0.40	0.51	0.77	1.07	1.42	3.16	6.04	9.67	18.86
450	0.11	0.16	0.23	0.32	0.42	0.54	0.81	1.13	1.51	3.38	6.48	10.37	20.25
500	0.11	0.17	0.24	0.33	0.44	0.56	0.85	1.20	1.59	3.59	6.90	11.05	21.57
600	0.11	0.17	0.25	0.35	0.47	0.60	0.92	1.31	1.75	4.00	7.70	12.33	24.06
700	0.11	0.18	0.26	0.37	0.49	0.64	0.99	1.42	1.90	4.37	8.44	13.52	26.39
800	0.11	0.18	0.27	0.38	0.52	0.67	1.05	1.51	2.04	4.73	9.14	14.65	28.59
900	0.11	0.18	0.28	0.39	0.54	0.70	1.11	1.60	2.18	5.07	9.81	15.72	30.69
1000	0.12	0.19	0.28	0.41	0.56	0.73	1.17	1.69	2.30	5.39	10.44	16.74	32.69
1500	0.12	0.20	0.32	0.46	0.64	0.86	1.40	2.07	2.85	6.82	13.31	21.35	41.69
2000	0.12	0.21	0.34	0.50	0.71	0.97	1.60	2.39	3.32	8.07	15.80	25.37	49.55
3000	0.13	0.23	0.37	0.57	0.82	1.13	1.93	2.93	4.12	10.22	20.13	32.35	63.19
4000	0.13	0.24	0.40	0.62	0.91	1.27	2.20	3.38	4.80	12.09	23.90	38.44	75.10
5000	0.14	0.25	0.43	0.67	0.99	1.39	2.43	3.78	5.40	13.77	27.31	43.95	85.86

## Cropping/Management Factor

The cropping factor,  $C_s$ , considers the protection of natural ground cover in preventing erosion of the soil. This is dependent on the type of vegetation (grass or trees) and the density of the vegetation on the site. The higher the value for  $C_s$ , the less protection from erosion is available; for example, a bare construction site with no groundcover has a  $C_s$  value of 1.0, while hay mulch applied at 1 ton per acre produces a  $C_s$  value of 0.13.

The  $C_s$  factor is not intended to account for the reduced erosion provided by temporary or final vegetation established on areas that have been disturbed. The erosion control factor,  $P$ , described below reflects the erosion protection afforded by use of vegetation in accordance with the [Section 2.9 Vegetation](#).

Table 1.6 provides approximate values for  $C_s$  for a variety of conditions. The sensitivity of the  $C_s$  value reflects the importance of minimizing the area of disturbance and providing protection to the disturbed soil before erosion occurs. **For existing bare areas or areas stripped of natural vegetation by construction, a  $C_s$  value of 1.0 shall be used.**

Type and Height of Raised Vegetative Canopy	Canopy Cover, %	Ground cover that contacts the surface, %					
		0	20	40	60	80	95-100
No appreciable canopy / Canopy of tall weeds or short brush (<1' tall)	0	0.450	0.200	0.100	0.042	0.013	0.003
	25	0.360	0.170	0.090	0.038	0.012	0.003
	50	0.260	0.130	0.070	0.035	0.012	0.003
	75	0.170	0.100	0.060	0.031	0.011	0.003
Appreciable brush or bushes (5' fall height)	25	0.400	0.180	0.090	0.040	0.013	0.003
	50	0.340	0.160	0.085	0.038	0.012	0.003
	75	0.280	0.140	0.080	0.036	0.012	0.003
Trees w/o appreciable low brush (>10' fall height)	25	0.420	0.190	0.100	0.041	0.013	0.003
	50	0.390	0.180	0.090	0.040	0.013	0.003
	75	0.360	0.170	0.090	0.039	0.012	0.003

(Source: Standard Handbook of Environmental Engineering edited by Robert A. Corbitt)

For each drainage basin, this  $C_s$  value is weighted based on the percentage of disturbed area in the basin:

$$C_{s\text{total}} = [(C_{s\text{un}} * A_{\text{un}}) + (C_{s\text{dis}} * A_{\text{dis}})] / A_{\text{total}} \quad (1.5)$$

where:

$C_{s\text{total}}$  =  $C_s$  for drainage basin

$C_{s\text{un}}$  =  $C_s$  for undisturbed areas

$A_{\text{un}}$  = Area of undisturbed areas of drainage basin (acres)

$C_{s\text{dis}}$  =  $C_s$  for disturbed areas

$A_{\text{dis}}$  = Area of disturbed areas of drainage basin (acres)

$A_{\text{total}}$  = Total area of drainage basin (acres)

## Erosion Control Practice Factor

The erosion control practice factor, P, accounts for the erosion control and sediment trapping effectiveness of land treatments such as mulching, erosion control blankets, temporary or final vegetation, sediment basins, filter berms, check dams, and other controls.

For the, A P value of 1 is used in the USLE calculation of the uncontrolled soil loss from the site ( $Z_{A_{uncontrolled}}$ ) because it is assumed that no controls are used.

The Efficiency Rating ( $F_e$ ) for the calculation of the soil erosion prevented/sediment retained on the site ( $Z_{A_{retained}}$ ) for the various controls is used in place of the erosion control practice factor. The Efficiency Rating is the compliment of the P value ( $F_e = 1 - P$ ) and is used instead of P, because the desired calculation is the soil retained on the site through the use of the practices rather than the soil lost from the site.

When multiple structural controls are used in series to treat runoff from disturbed areas, the design efficiency can be calculated as follows<sup>1</sup>:

$$F_{eTOTAL} = 1 - ((1 - F_{e1}) * (1 - F_{e2})) \quad (1.6)$$

where:

$F_{e1}$  = Removal efficiency of first control

$F_{e2}$  = Removal efficiency of second control

## Site Rating Factor Calculation

After erosion potential is calculated for both uncontrolled ( $Z_{A_{uncontrolled}}$ ) and controlled conditions ( $Z_{A_{retained}}$ ), a site rating (SR) is calculated using Equation 1.1.

**A minimum design storm of 2-year intensity and 24-hour duration shall be used for design of structural sediment control techniques.** Other design criteria are defined in sections of the manual for specific erosion controls. The 2-year intensity is the rainfall intensity that has a 50 percent probability of occurring in any given year. The 24-hour duration establishes the overall volume of rainfall and runoff of the storm with a peak flow of the referenced intensity. Municipalities can adjust this requirement for particularly sensitive areas or other areas of concern.

### 1.3.4 Summary

The following outlines the primary steps required to calculate the Site Rating.

#### I. Develop design storm flows.

Determine drainage sub-basin.

Determine  $C_s$  values and drainage patterns (LS) based on conditions for design period.

#### II. Calculate theoretical soil loss for each sub-basin if no controls are used.

Use value of 1 for the Erosion Control Practice factor, P, since no controls are used.

#### III. Calculate theoretical soil uneroded and/or retained for each sub-basin by use of controls.

Use  $F_e$  from [Section 2.0 Erosion Controls](#) and [Section 3.0 Sediment Controls](#) (or test/manufacture's data) in place of P in USLE.

Calculate soil retained onsite due to use of controls.

#### IV. Determine site rating.

<sup>1</sup>Hartigan, P. and K. Wilweding, *The Clean Colorado Project and Urban Nonpoint Source Pollution Control: The LCRA Program, Seminar Publication - Nonpoint Source Watershed Workshop, Environmental Protection Agency, Sept. 1991, p. 170.*

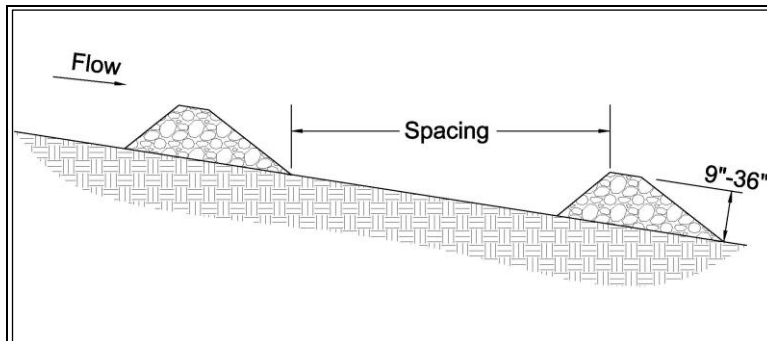
Total sediment loss from the site must be reduced by a minimum of 70 percent from uncontrolled conditions (Site Rating > 0.70).

For sites that include phasing of the construction, repeat the steps for each phase.

## 2.0 Erosion Controls

### 2.1 Check Dam

Erosion Control



**Description:** Check dams are small barriers consisting of loose rock, rock bags, or organic filter tubes placed across a drainage swale or ditch. They reduce the velocity of small concentrated flows, provide a limited barrier for sediment and reduce the potential for erosion of the swale or ditch.

#### KEY CONSIDERATIONS

**DESIGN CRITERIA:**

- Heights between 9 inches and 36 inches
- Top of the downstream dam should be at the same elevation as the toe of the upstream dam

**ADVANTAGES / BENEFITS:**

- Reduced velocities in long drainage swales or ditches
- May be used with other channel protection measures
- Provides some sediment removal

**DISADVANTAGES / LIMITATIONS:**

- Cannot be used in live stream channels
- Minor ponding upstream of the check dams
- Extensive maintenance or replacement of the dams required after heavy flows or high velocity flows
- Mowing hazard from loose rocks if all rock is not removed at end of construction

**MAINTENANCE REQUIREMENTS:**

- Inspect regularly
- Remove silt when it reaches approximately 1/3 the height of the dam or 12 inches, whichever is less

#### TARGETED POLLUTANTS

- Sediment
- Nutrients & Toxic Materials
- Oil & Grease
- Floatable Materials
- Other Construction Wastes

#### APPLICATIONS

Perimeter Control

Slope Protection

Sediment Barrier

Channel Protection

Temporary Stabilization

Final Stabilization

Waste Management

Housekeeping Practices

**Fe=0.30-0.50**

*(Depends on soil type)*

#### IMPLEMENTATION CONSIDERATIONS

- Capital Costs
- Maintenance
- Training
- Suitability for Slopes > 5%

**Other Considerations:**

- None

### 2.1.1 Primary Use

Check dams are used in long drainage swales or ditches to reduce erosive velocities. They are typically used in conjunction with other channel protection techniques such as vegetation lining and turf reinforcement mats. Check dams provide limited treatment to sediment-laden flows. They are more useful in reducing flow velocities to acceptable levels for stabilization methods. Check dams may be used in combination with stone outlet sediment traps, where the check dams prevent erosion of the swale while the sediment trap captures sediment at the downstream end of the swale.

### 2.1.2 Applications

Check dams are typically used in swales and drainage ditches along linear projects such as roadways. They can also be used in short swales down a steep slope, such as swales down a highway embankment, to reduce velocities. Check dams shall not be used in live stream channels.

Check dams should be installed before the contributing drainage area is disturbed, so as to mitigate the effects on the swale from the increase in runoff. If the swale itself is graded as part of the construction activities, check dams are installed immediately upon completion of grading to control velocities in the swale until stabilization is completed.

### 2.1.3 Design Criteria

#### General Criteria

- Typically, the dam height should be between 9 inches and 36 inches, depending on the material of which they are made. The height of the check dam shall always be less than one-third the depth of the channel.
- Dams should be spaced such that the top of the downstream dam is at the same elevation as the toe of the upstream dam. On channel grades flatter than 0.4 percent, check dams should be placed at a distance that allows small pools to form between each check dam.
- The top of the side of the check dam shall be a minimum of 12 inches higher than the middle of the dam. In addition, the side of the dams shall be embedded a minimum of 18 inches into the side of the drainage ditch, swale or channel to minimize the potential for flows to erode around the side of the dam.
- Larger flows (greater than 2-year, 24-hour design storm) must pass the check dam without causing excessive upstream flooding.
- Check dams should be used in conjunction with other sediment reduction techniques prior to releasing flow offsite.
- Use geotextile filter fabric under check dams of 12 inches in height or greater. The fabric shall meet the following minimum criteria:
  - Tensile Strength, ASTM D4632 Test Method for Grab Breaking Load and Elongation of Geotextiles, 250-lbs.
  - Puncture Rating, ASTM D4833 Test Method for Index Puncture Resistance of Geotextiles, Geomembranes, and Related Products, 135-lbs.
  - Mullen Burst Rating, ASTM D3786 Standard Test Method for Hydraulic Bursting Strength of Textile Fabrics-Diaphragm Bursting Strength Tester Method, 420-psi.
  - Apparent Opening Size, ASTM D4751 Test Method for Determining Apparent Opening Size of a Geotextile, U.S. Sieve No. 20 (max).
- Loose, unconfined soil, wood chips, compost, and other material that can float or be transported by runoff shall not be used to construct check dams.



## Rock Check Dams

- Stone shall be well graded with stone size ranging from 3 to 6 inches in diameter for a check dam height of 24 inches or less. The stone size range for check dams greater than 24 inches is 4 to 8 inches in diameter.
- Rock check dams shall have a minimum top width of 2 feet with side slopes of 2:1 or flatter.

## Rock Bag Check Dams

- Rock bag check dams should have a minimum top width of 16 inches.
- Bag length shall be 24 inches to 30 inches, width shall be 16 inches to 18 inches and thickness shall be 6 inches to 8 inches and having a minimum weight of 40 pounds.
- Minimum rock bag dam height of 12 inches would consist of one row of bags stacked on top of two rows of bag. The dam shall always be one more row wide than it is high, stacked pyramid fashion.
- Bags should be filled with pea gravel, filter stone, or aggregate that is clean and free of deleterious material.
- Sand bags shall not be used for check dams, due to their propensity to break and release sand that is transported by the concentrated flow in the drainage swale or ditch.
- Bag material shall be polypropylene, polyethylene, polyamide or cotton burlap woven fabric, minimum unit weight 4-ounces-per-square-yard, Mullen burst strength exceeding 300-psi as determined by ASTM D3786, Standard Test Method for Hydraulic Bursting Strength of Textile Fabrics-Diaphragm Bursting Strength Tester Method, and ultraviolet stability exceeding 70 percent.
- PVC pipes may be installed through the dam to allow for controlled flow through the dam. Pipe should be schedule 40 or heavier polyvinyl chloride (PVC) having a nominal internal diameter of 2 inches.

## Sack Gabion Check Dams

- Sack gabion check dams may be used in channels with a contributing drainage area of 5 acres or less.
- Sack gabions shall be wrapped in galvanized steel, woven wire mesh. The wire shall be 20 gauge with 1 inch diameter, hexagonal openings.
- Wire mesh shall be one piece, wrapped around the rock, and secured to itself on the downstream side using wire ties or hog rings.
- Sack gabions shall be staked with  $\frac{3}{4}$  inch rebar at a maximum spacing of three feet. Each wire sack shall have a minimum of two stakes.
- Stone shall be well graded with a minimum size range from 3 to 6 inches in diameter.

## Organic Filter Tube Check Dams

- Organic filter tubes may be used as check dams in channels with a contributing drainage area of 5 acres or less.
- Organic filter tubes shall be a minimum of 12 inches in diameter.
- Filter material used within tubes to construct check dams shall be limited to coir, straw, aspen fiber and other organic material with high cellulose content. The material should be slow to decay or leach nutrients in standing water.
- Staking of filter tubes shall be at a maximum of 4 foot spacing and shall alternate through the tube and on the downstream face of the tube.
- Unless superseded by requirements in this section, filter tubes and filter material shall comply with the

criteria in *Section 3.6 Organic Filter Tubes*.

### 2.1.4 *Design Guidance and Specifications*

Specifications for construction of this item may be found in the Standard Specifications for Public Works Construction – North Central Texas Council of Governments, Section 201.9 Check Dam (Rock). Specifications are also available in the Standard Specifications for Construction and Maintenance of Highways, Streets, and Bridges (TxDOT 2004), Item 506.2.A and Item 506.4.C.1.

### 2.1.5 *Inspection and Maintenance Requirements*

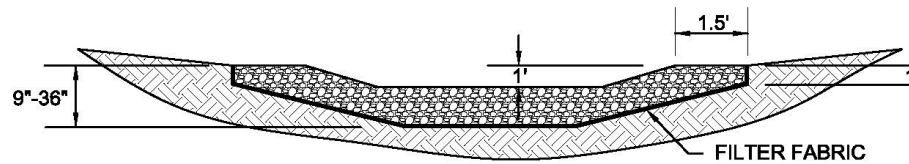
Check dams should be inspected regularly (at least as often as required by the TPDES Construction General Permit). Silt must be removed when it reaches approximately 1/3 the height of the dam or 12 inches, whichever is less. Inspectors should monitor the edges of the dam where it meets the sides of the drainage ditch, swale or channel for evidence of erosion due to bypass or high flows. Eroded areas shall be repaired. If erosion continues to be a problem, modifications to the check dam or additional controls are needed.

Care must be used when taking out rock check dams in order to remove as much rock as possible. Loose rock can create an extreme hazard during mowing operations once the area has been stabilized.

### 2.1.6 *Example Schematics*

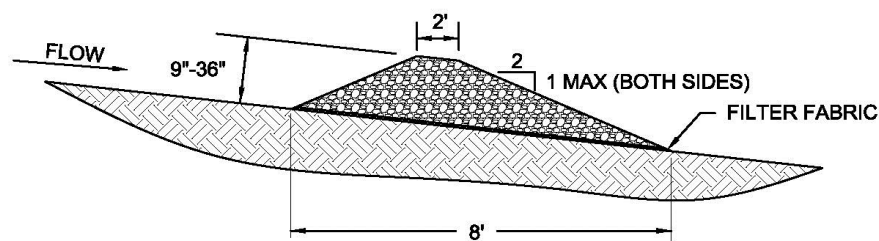
The following schematics are example applications of the construction control. They are intended to assist in understanding the control's design and function.

The schematics are **not for construction**. They may serve as a starting point for creating a construction detail, but they must be adapted for the site by the designer. Dimensions and notes appropriate for the application must also be added by the designer.



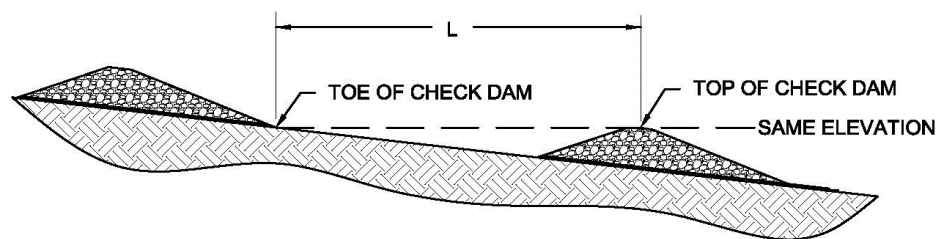
**ROCK CHECK DAM VIEW LOOKING UPSTREAM**

N.T.S.



**CROSS SECTION OF ROCK CHECK DAM**

N.T.S.



**SPACING BETWEEN ROCK CHECK DAMS**

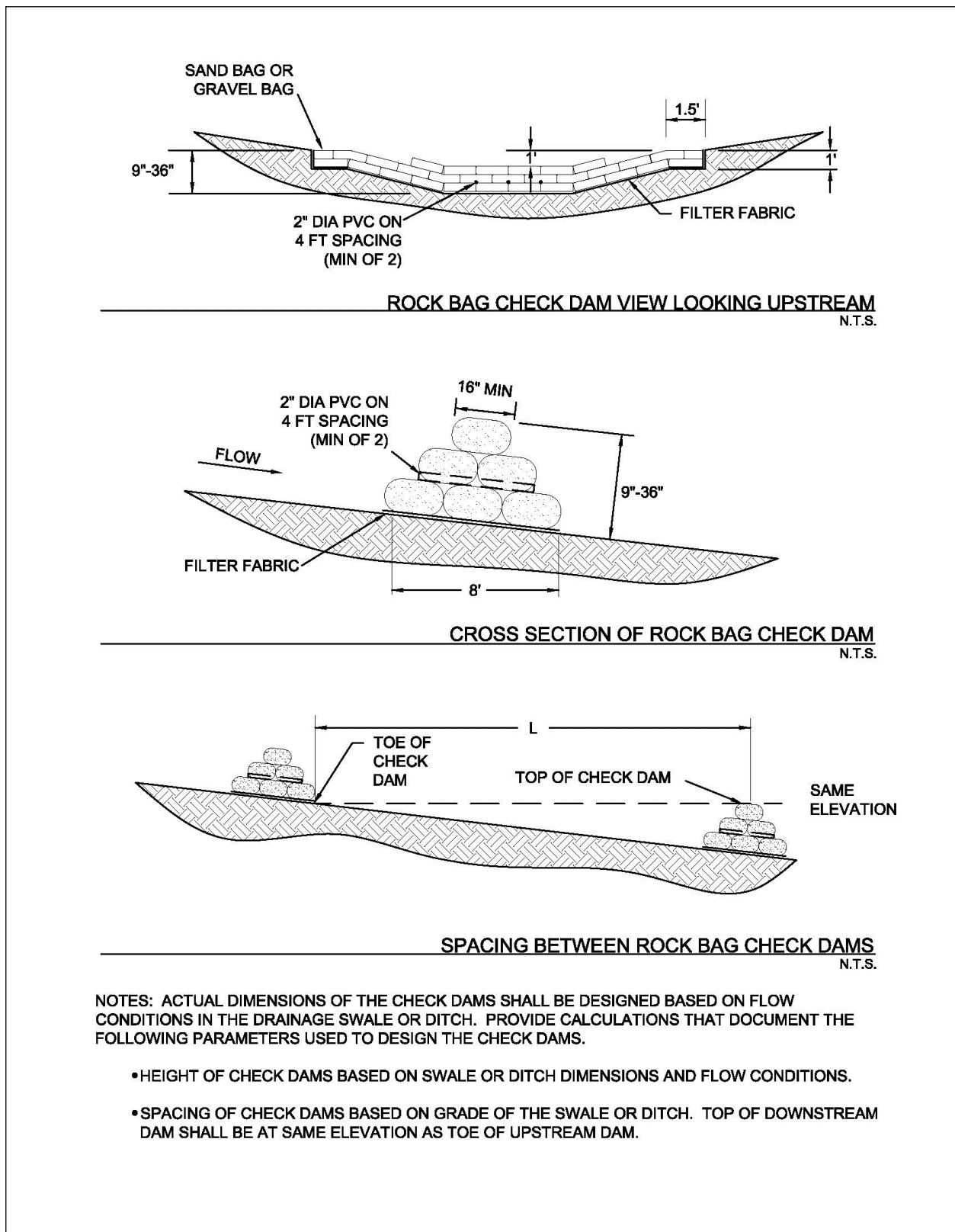
N.T.S.

**NOTES:** ACTUAL DIMENSIONS OF THE CHECK DAMS SHALL BE DESIGNED BASED ON FLOW CONDITIONS IN THE DRAINAGE SWALE OR DITCH. PROVIDE CALCULATIONS THAT DOCUMENT THE FOLLOWING PARAMETERS USED TO DESIGN THE CHECK DAMS.

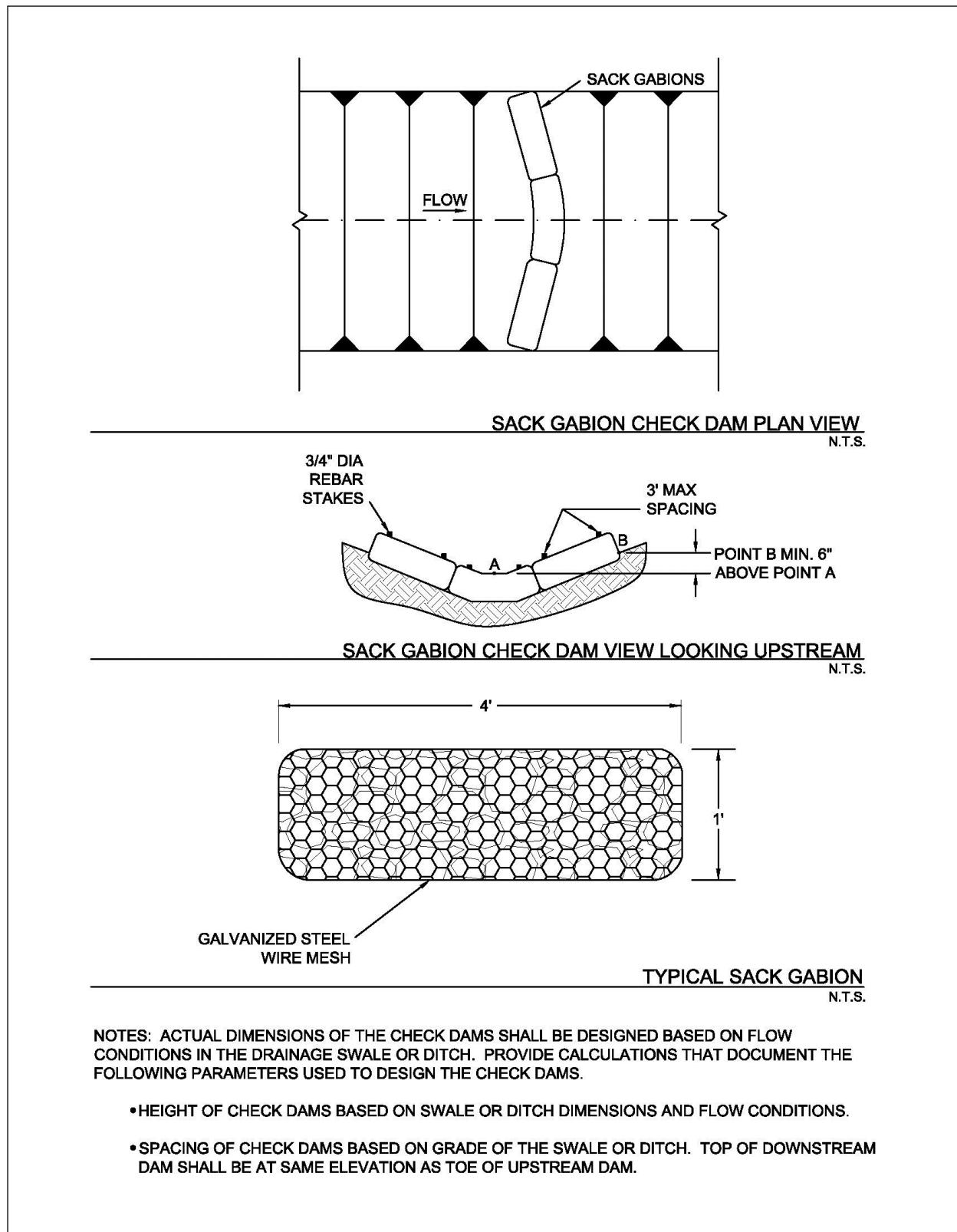
- HEIGHT OF CHECK DAMS BASED ON SWALE OR DITCH DIMENSIONS AND FLOW CONDITIONS.
- SPACING OF CHECK DAMS BASED ON GRADE OF THE SWALE OR DITCH. TOP OF DOWNSTREAM DAM SHALL BE AT SAME ELEVATION AS TOE OF UPSTREAM DAM

**Figure 2.1 Schematics of Rock Check Dams**

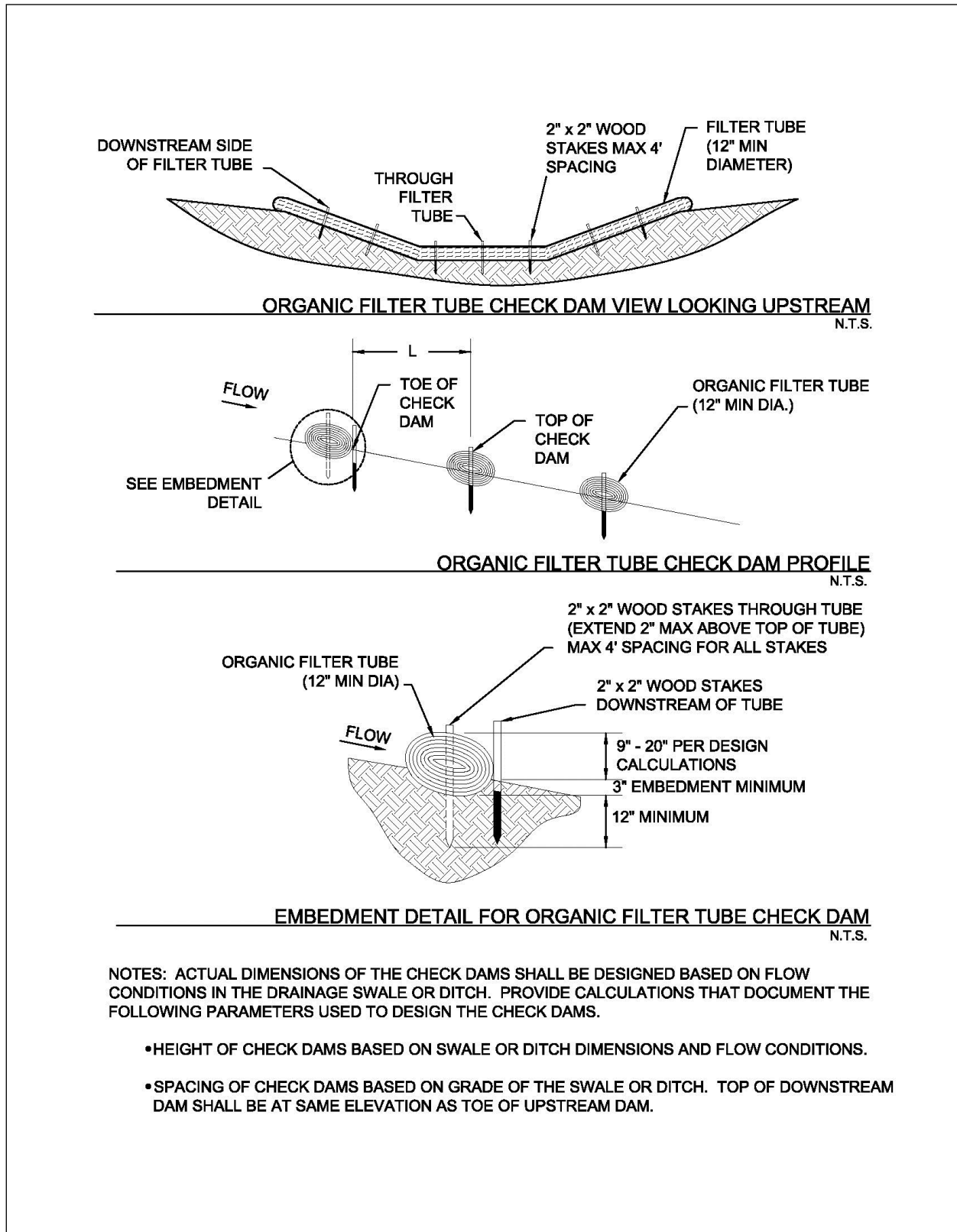
(Source: Modified from Stormwater Management Manual for Western Washington)



**Figure 2.2 Schematics of Rock Bag Check Dams**



**Figure 2.3 Schematics of Sack Gabion Check Dams**  
(Source: Modified from Texas Department of Transportation Detail Sheet EC (2)-93)

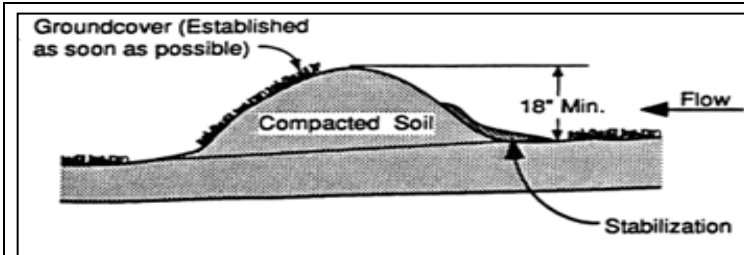


**Figure 2.4 Schematics of Organic Filter Tube Check Dams**

(Source: Modified from City of Plano BMP S-7)

## 2.2 Diversion Dike

### Erosion Control



**Description:** A diversion dike is a compacted soil mound, which redirects runoff to a desired location. The dike is typically stabilized with natural grass for low velocities or with stone or erosion control mats for higher velocities.

### KEY CONSIDERATIONS

#### DESIGN CRITERIA:

- Maximum 1 foot flow depth at the dike for a 2-year return period design storm peak flow
- Side slopes 3:1 or flatter
- Minimum 2 feet top width
- Minimum embankment height of 18 inches measured from toe of slope on upgrade side
- Maximum contributing drainage area of 5 acres or less

#### ADVANTAGES / BENEFITS:

- Easy to install during early grading operations
- Very effective in reducing erosion at a reasonable cost
- Can be used in combination with an interceptor swale

#### DISADVANTAGES / LIMITATIONS:

- Must be stabilized immediately after placement or the dike will become a sediment source
- Can be a hindrance to construction equipment moving on the site

#### MAINTENANCE REQUIREMENTS:

- Inspect regularly
- Remove silt
- Repair erosion on the face of the dike
- Provide additional stabilization if erosion occurs

### TARGETED POLLUTANTS

- Sediment
- Nutrients & Toxic Materials
- Oil & Grease
- Floatable Materials
- Other Construction Wastes

### APPLICATIONS

Perimeter Control

Slope Protection

Sediment Barrier

Channel Protection

Temporary Stabilization

Final Stabilization

Waste Management

Housekeeping Practices

**Fe=0.95**

### IMPLEMENTATION CONSIDERATIONS

- Capital Costs
- Maintenance
- Training
- Suitability for Slopes > 5%

#### Other Considerations:

- None

### 2.2.1 Primary Use

The primary use of diversion dikes is to prevent erosion by diverting runoff away from steep slopes and disturbed areas. The diversion dike is normally used to intercept offsite flow upstream of the construction area and direct the flow around the disturbed soils. It can also be used downstream of the construction area to direct flow into a sediment control, such as a sediment basin or protected inlet. The diversion dike serves the same purpose as an interceptor swale and, based on the topography of the site, can be used in combination with an interceptor swale.

### 2.2.2 Applications

By intercepting runoff before it has the chance to cause erosion, diversion dikes are very effective in reducing erosion at a reasonable cost. They are applicable to a large variety of projects including site developments and linear projects, such as roadways and pipeline construction. Diversion dikes are normally used as upslope perimeter controls for construction sites with large amounts of offsite flow that needs to be re-directed around the construction site. They can also be used as a downslope perimeter control to direct runoff from the disturbed area to a sediment control.

Used in combination with swales, the diversion dike can be quickly installed with a minimum of equipment and cost, using the swale excavation material to construct the dike. No sediment removal technique is required if the dike is properly stabilized and the runoff is intercepted prior to crossing disturbed areas.

Significant savings in sediment controls can be realized by using diversion dikes to direct sheet flow from disturbed areas to a central sediment control, such as a sediment basin or other sediment trap, instead of installing a series of high-maintenance linear controls. Dikes can also be used to direct runoff from disturbed areas to a filtration device, passive treatment system, or active treatment system when these are necessary to attain required levels of sediment removal.

### 2.2.3 Design Criteria

- The maximum contributing drainage area should be 5 acres or less depending on site conditions.
- Maximum depth of flow at the dike shall be 1 foot based on a 2-year return period design storm peak flow.
- Side slopes of the diversion dike shall be 3:1 or flatter.
- Side slopes of the diversion dike may be 2:1 for dike installations to be used less than 3 months, if the dike is within an area protected by perimeter controls.
- Minimum width at the top of the dike shall be 2 feet.
- Minimum embankment height shall be 18 inches as measured from the toe of slope on the upgrade side of the berm.
- For grades less than 2 percent and velocities less than 6 feet per second, the minimum required channel stabilization shall be grass, erosion control blankets, or anchored mulch. For grades in excess of 2 percent or velocities exceeding 6 feet per second, stabilization is required in the form of turf reinforcement mats (or riprap with appropriate size, gradation, and thickness depending on flow conditions). Velocities greater than 8 feet per second will require approval by the local municipality and is discouraged.
- Refer to [Section 2.9 Vegetation](#) for design criteria and guidance on establishing vegetation in the swale.
- The dikes shall remain in place until all disturbed areas that are protected by the dike are permanently stabilized unless other controls are put into place to protect the disturbed area.
- The flow line at the dike shall have a positive grade to drain to a controlled outlet.



- Diverted runoff from a disturbed or exposed upland area shall be conveyed to a sediment-trapping device.
- The soil for the dike shall be placed in lifts of 8 inches or less and be compacted to 95 percent standard proctor density using ASTM D698 Standard Test Methods for Laboratory Compaction Characteristics of Soil Using Standard Effort.
- Soil used in construction of the dike can be onsite material. It should be free of rocks larger than three inches in diameter and should be clay, silty clay or sandy clay with a plasticity index greater than 25. If only low PI material is available, it will be necessary to armor the slopes with stone or geotextile to prevent erosion of the dike.
- An interceptor swale may be installed on the upslope side of the diversion dike. Refer to [Section 2.4 Interceptor Swale](#) for swale design criteria.

### 2.2.4 Design Guidance and Specifications

Specifications for construction of this item may be found in the Standard Specifications for Public Works Construction – North Central Texas Council of Governments, Section 201.7 Diversion Dike.

### 2.2.5 Inspection and Maintenance Requirements

Dikes should be inspected regularly (at least as often as required by the TPDES Construction General Permit) to determine if silt is building up behind the dike or if erosion is occurring on the face of the dike. Silt shall be removed in a timely manner. If erosion is occurring on the face of the dike, the face of the slopes shall either be stabilized with mulch or seeding or the slopes shall be flattened.

### 2.2.6 Example Schematics

The following schematics are example applications of the construction control. They are intended to assist in understanding the control's design and function.

The schematics are **not for construction**. They may serve as a starting point for creating a construction detail, but they must be site adapted by the designer. In addition, dimensions and notes appropriate for the application must be added by the designer.

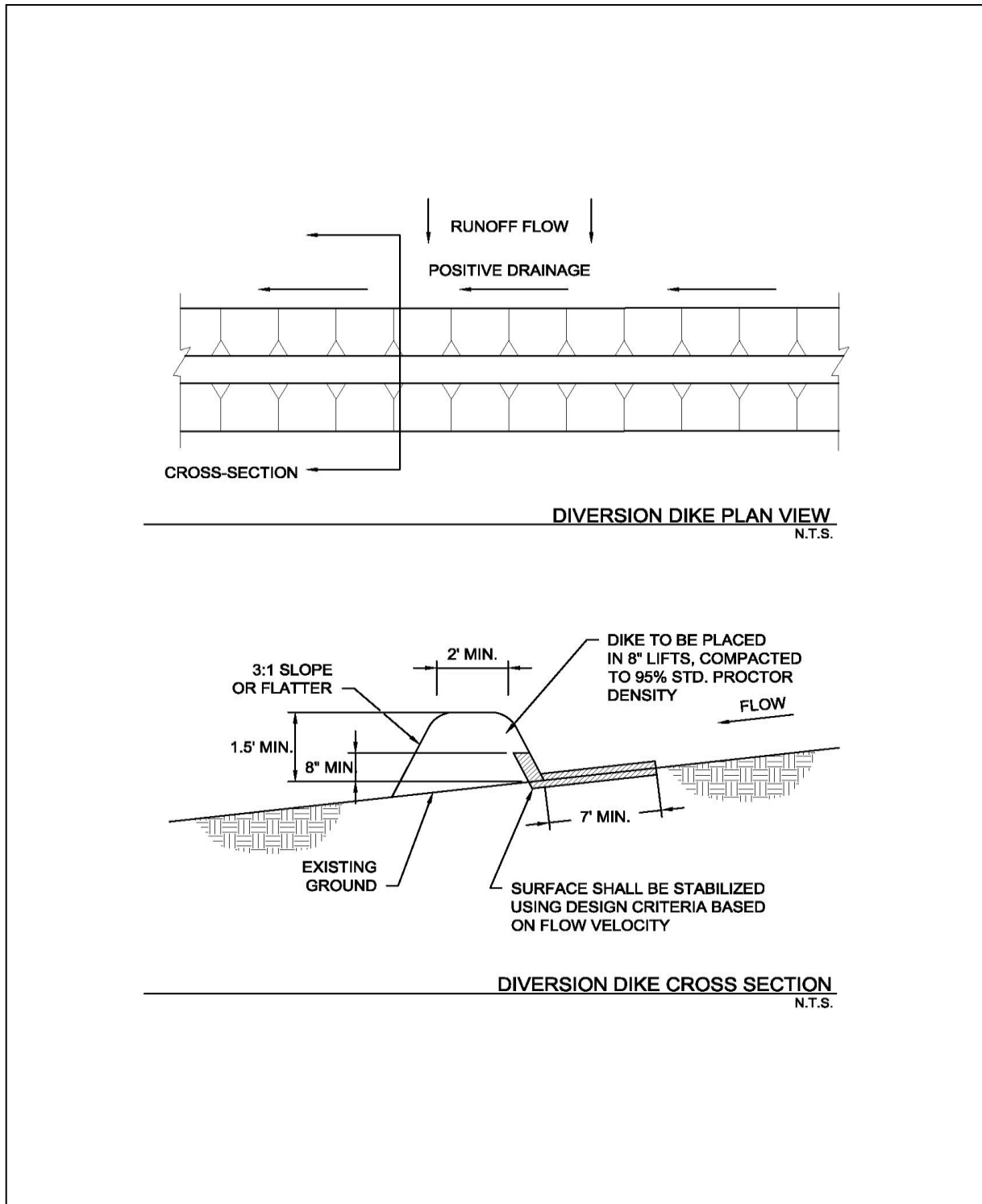


Figure 2.5 Schematics of Diversion Dike

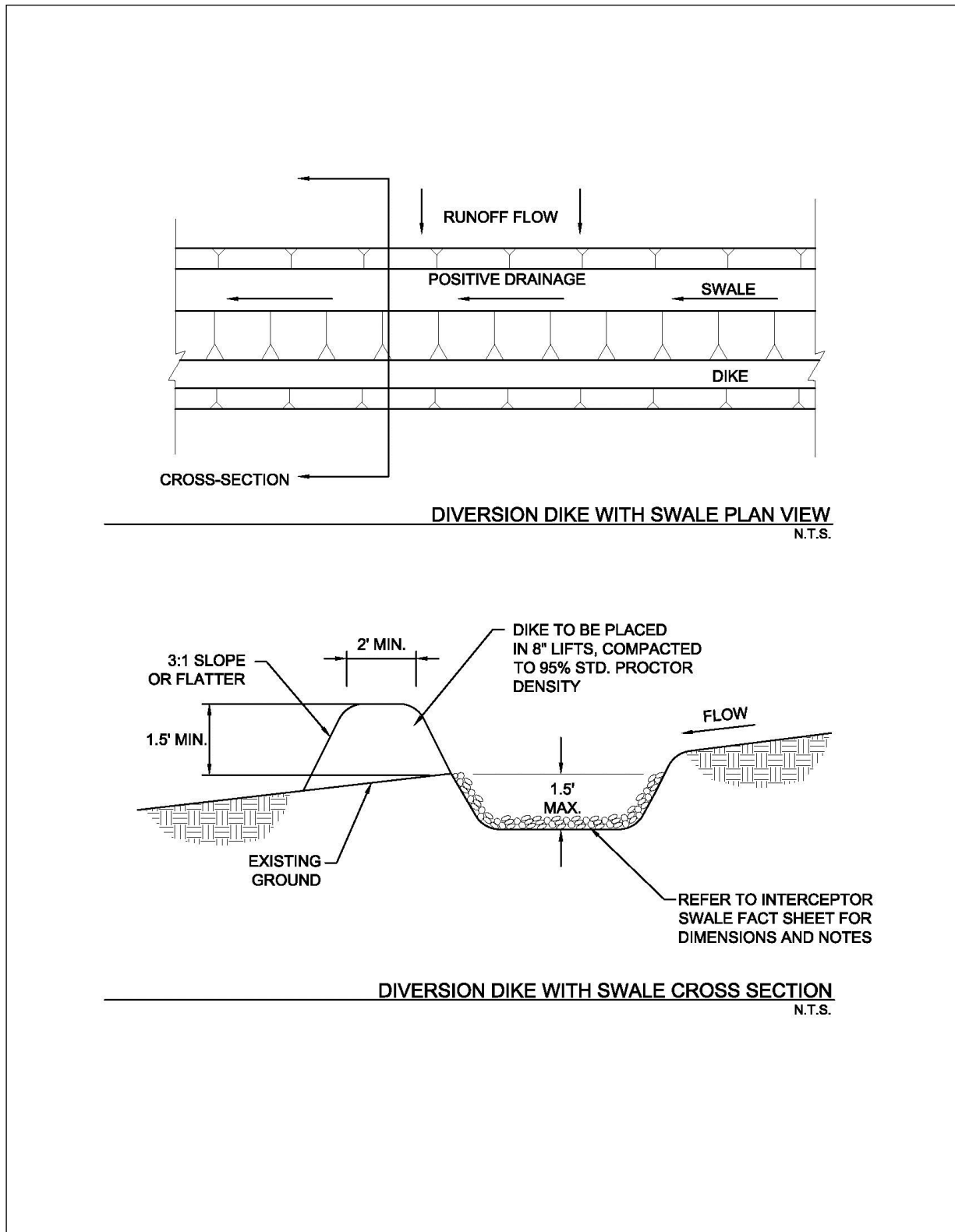
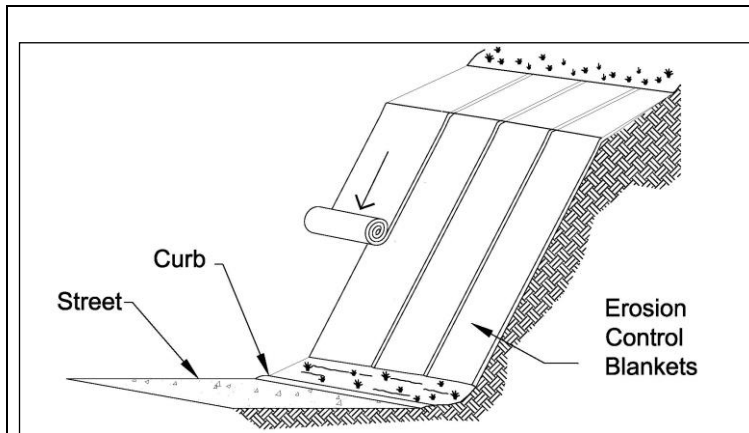


Figure 2.6 Schematics of Diversion Dike with Swale

## 2.3 Erosion Control Blankets

Erosion Control



**Description:** An erosion control blanket (ECB) is a temporary, degradable, rolled erosion control product that reduces soil erosion and assists in the establishment and growth of vegetation. ECBs, also known as soil retention blankets, are manufactured by many companies and are composed primarily of processed, natural, organic materials that are woven, glued, or structurally bound together with natural fiber netting or mesh on one or both sides.

### KEY CONSIDERATIONS

**DESIGN CRITERIA:**

- ECB selected based on slope, flow rate and length of service
- Specify preparation of soil surface to ensure uniform contact with blanket
- Installation and anchoring according to manufacturer's recommendations

**ADVANTAGES / BENEFITS:**

- Holds seed and soil in place until vegetation is established
- Effective for slopes, embankments and small channels

**DISADVANTAGES / LIMITATIONS:**

- Not for use on slopes greater than 2:1 or in channels with shear stresses greater than 2.0 pounds per square foot

**MAINTENANCE REQUIREMENTS:**

- Replace or re-anchor loosened blankets
- Remove sediment deposited on blankets

### TARGETED POLLUTANTS

- Sediment
- Nutrients & Toxic Materials
- Oil & Grease
- Floatable Materials
- Other Construction Waste

### APPLICATIONS

<b>Perimeter Control</b>
<b>Slope Protection</b>
<b>Sediment Barrier</b>
<b>Channel Protection</b>
<b>Temporary Stabilization</b>
<b>Final Stabilization</b>

**Waste Management**

**Housekeeping Practices**

**Fe=0.90** (*Ground cover*)

**Fe=0.65**

(*Perimeter w/o vegetation*)

### IMPLEMENTATION CONSIDERATIONS

- Capital Costs
- Maintenance
- Training
- Suitability for Slopes > 5%

**Other Considerations:**

- *Life expectancy, partial degradation, and mowing/maintenance issues for ECBs left in place as part of final stabilization*

### 2.3.1 Primary Use

Erosion control blankets (ECBs) are used to hold seed and soil in place until vegetation is established on disturbed areas. They can be used on many types of disturbed areas, but are particularly effective for slopes and embankments and in small drainage swales.

ECBs seeded for vegetation may be used as a perimeter control. When used in combination with other sediment barriers, such as silt fence or organic filter tubes, blankets may be used as a perimeter control with or without vegetation.

### 2.3.2 Applications

ECBs may be used on many types of disturbed areas but are most applicable on gradual to steep (2:1) cut/fill slopes and in swales and channels with low to moderate flow velocities. In these applications they may provide temporary stabilization by themselves or may be used with seeding to provide final stabilization. ECBs are also used to establish vegetation in channels where velocities are less than 6.0 feet per second.

When seeded for establishment of vegetation, ECBs can be an effective perimeter along the down slope side of linear construction projects (roads and utilities). ECBs with vegetation are also used as perimeter controls for new development, particularly at the front on residential lots in new subdivisions. ECBs are an effective aid in establishing vegetated filter strips.

### 2.3.3 Design Criteria

- The designer shall specify the manufacturer, type of erosion control blanket to be used, and dimensioned limits of installation based on the site topography and drainage.
- The type and class of erosion control blanket must be specified in accordance with the manufacturer's guidance for the slope of the area to be protected, the flow rate (sheet flow on cut/fill slopes) or velocity (concentrated flow in swales) of stormwater runoff in contact in with the ECB, and the anticipated length of service.
- ECBs should meet the applicable "Minimum Performance Standards for TxDOT" as published by TxDOT in its "Erosion Control Report" and/or be listed on the most current annual "Approved Products List for TxDOT" applicable to TxDOT Item 169 Soil Retention Blanket and its Special Provisions.
- ECBs shall be installed vertically down slope (across contours) on cut/fill slopes and embankments and along the contours (parallel to flow) in swales and drainage ditches.
- ECBs designed to remain onsite as part of final stabilization shall have netting or mesh only on one side (the exposed side) of the ECB. The ECB shall be installed with the side that does not have netting or mesh in contact with the soil surface. All materials in the ECB, including anchors, should be 100 percent biodegradable within three years.
- On cut/fill slopes and drainage ditches or swales designed to receive erosion control blankets for temporary or final stabilization, installation of the ECBs shall be initiated immediately after completing grading of the slope or drainage way, and in no case later than 14 days after completion of grading these features. Do not delay installation of ECBs on these highly-erodible areas until completion of construction activities and stabilization of the remainder of the site.
- Unless the ECB is seeded to establish vegetation, perimeter control applications shall be limited to thirty foot wide drainage areas (i.e. linear construction projects) for an 8 foot width of ECB. When seeded for vegetation, use of ECBs for perimeter control shall follow the criteria in the [Section 3.15 Vegetated Filter Strips and Buffers](#).
- Prior to the installation of the ECB, all rocks, dirt clods, stumps, roots, trash and any other obstructions that would prevent the ECB from lying in direct contact with the soil shall be removed.

- Anchor trenching shall be located along the top of slope of the installation area, except for small areas with less than 2 percent slope.
- Installation and anchoring shall conform to the recommendations shown within the manufacturer's published literature for the erosion control blanket. Anchors (staples) shall be a minimum of 6 inches in length and 1 inch wide. They shall be made of 11-gauge wire, or equivalent, unless the ECB is intended to remain in place with final stabilization and biodegrade.
- Particular attention must be paid to joints and overlapping material. Overlap along the sides and at the ends of ECBs should be per the manufacturer's recommendations for site conditions and the type of ECB being installed. At a minimum, the end of each roll of ECB shall overlap the next roll by 3 feet and the sides of rolls shall overlap 4 inches.
- After installation, the blankets should be checked for uniform contact with the soil, security of the lap joints, and flushness of the staples with the ground.
- When ECBs are installed to assist with establishing vegetation, seeding shall be completed before installation of the ECB. Criteria for seeding are provided in [Section 2.9 Vegetation](#).
- Turf Reinforcement Mats should be used instead of ECBs for permanent erosion control and for stabilizing slopes greater than 2:1.
- ECBs are limited to use in swales and channels that have shear stresses of less than 2.0 pounds per square foot. Turf reinforcement mats shall be used in open channels with higher shear stresses.

### 2.3.4 Design Guidance and Specifications

Specifications for construction of this item may be found in the Standard Specifications for Public Works Construction – North Central Texas Council of Governments, Section 201.15 Erosion Control Blankets and in Item 169 of the Standard Specifications for Construction and Maintenance of Highways, Streets, and Bridges (TxDOT, 2004).

### 2.3.5 Inspection and Maintenance Requirements

Erosion control blankets should be inspected regularly (at least as often as required by the TPDES Construction General Permit) for bare spots caused by weather or other events. Missing or loosened blankets must be replaced or re-anchored.

Check for excess sediment deposited from runoff. Remove sediment and/or replace blanket as necessary. In addition, determine the source of excess sediment and implement appropriate measures to control the erosion. Also check for rill erosion developing under the blankets. If found, repair the eroded area. Determine the source of water causing the erosion and add controls to prevent its reoccurrence.

### 2.3.6 Example Schematics

The following schematics are example applications of the construction control. They are intended to assist in understanding the control's design and function.

The schematics are **not for construction**. The designer is responsible for working with ECB manufacturers to ensure the proper ECB is specified based on the site topography and drainage. Installation measures should be dictated by the ECB manufacturer and are dependent on the type of ECB installed. Manufacturer's recommendations for overlap, anchoring, and stapling shall always be followed. Criteria shown here are applicable only when they are more stringent than those provided by the manufacturer.

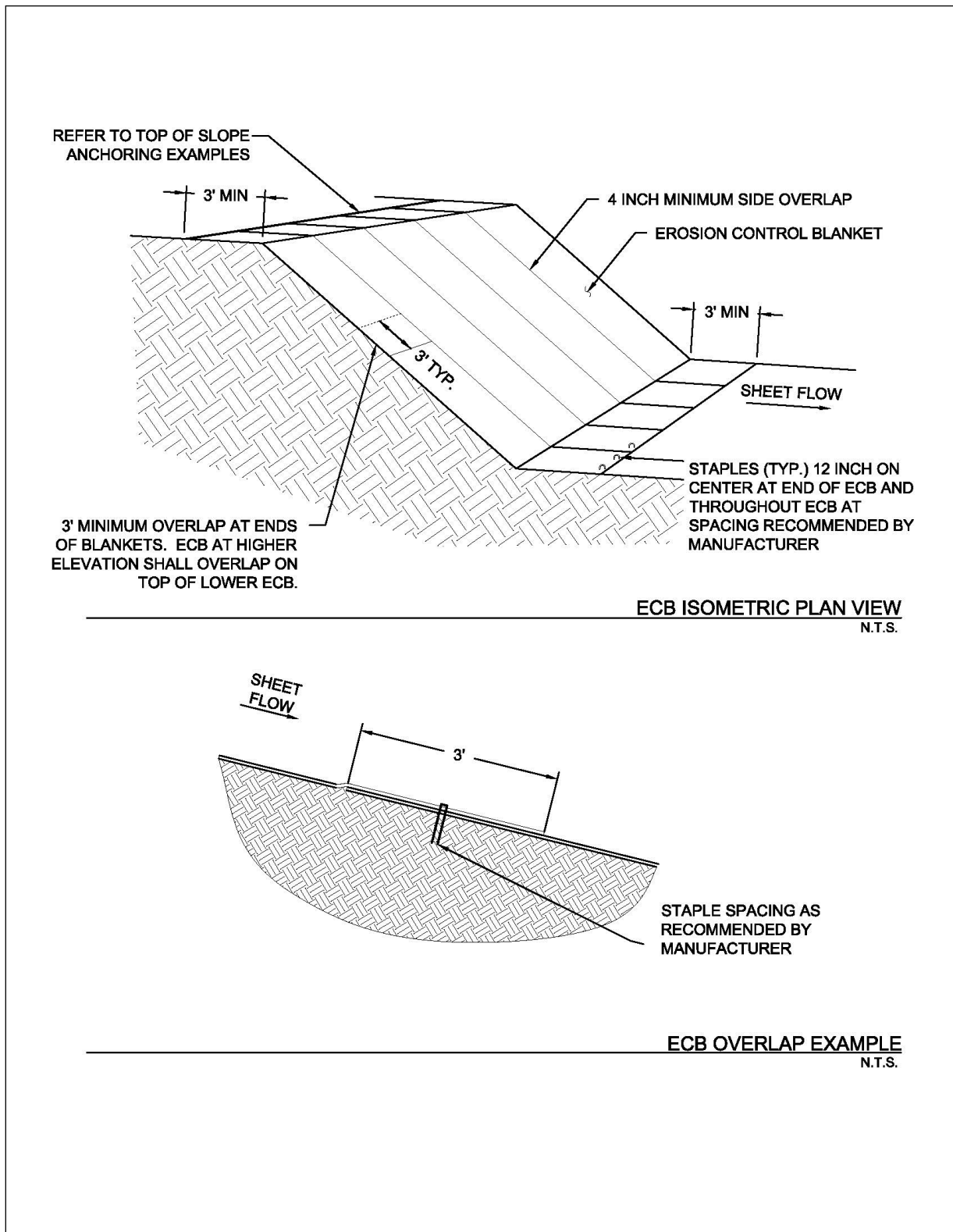
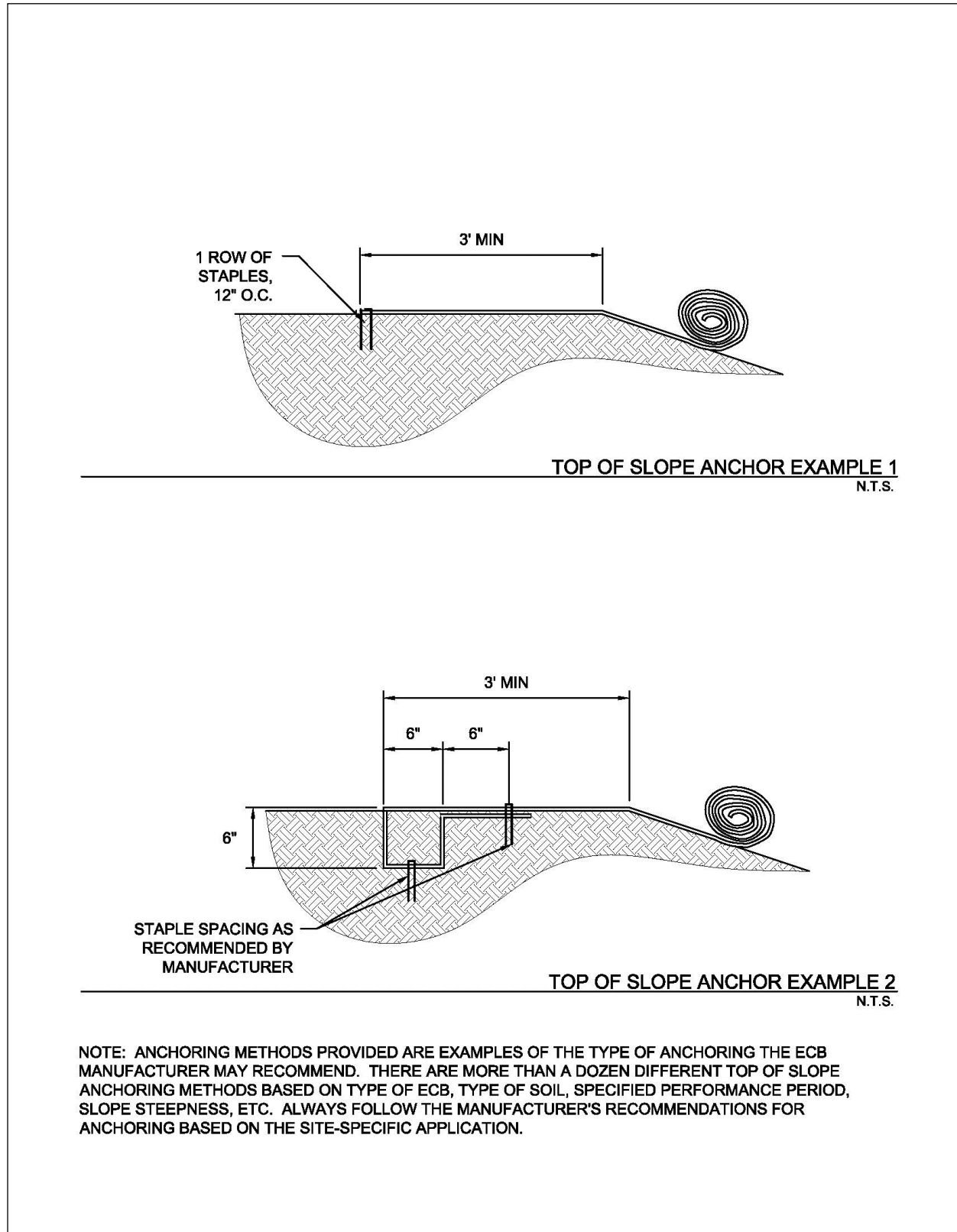


Figure 2.7 Schematics of Erosion Control Blankets



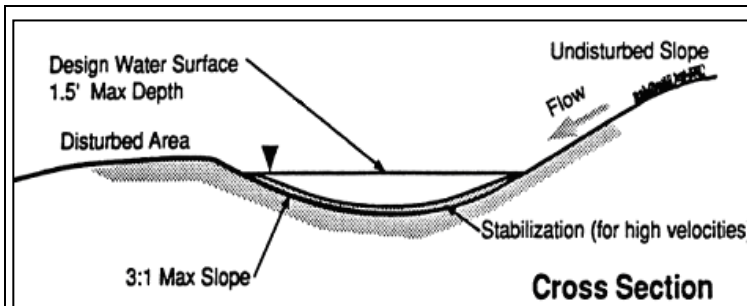
**Figure 2.8 Anchor Examples for Erosion Control Blankets**

(Sources: American Excelsior Company and Western Excelsior Corporation)



## 2.4 Interceptor Swale

Erosion Control



**Description:** An interceptor swale is a small v-shaped, trapezoidal, or parabolic channel that collects runoff and directs it to a desired location. It can either have a natural grass lining or, depending on slope and design velocity, a protective lining of erosion control blankets, turf reinforcement mats, or rock riprap.

### KEY CONSIDERATIONS

**DESIGN CRITERIA:**

- Maximum flow depth of 1.5 feet for a 2-year, 24-hour design storm
- Side slopes 3:1 or flatter
- Minimum freeboard of 6 inches
- Maximum velocity of 8 fps with stabilization
- Maximum contributing drainage area of 5 acres

**ADVANTAGES / BENEFITS:**

- Prevents erosion and reduces cost of sediment controls by directing “clean” runoff around disturbed areas
- Easy to install during early grading operations

**DISADVANTAGES / LIMITATIONS:**

- Must be stabilized immediately after excavation or the swale will become a sediment source
- May be unsuitable to the site conditions (too flat or steep)

**MAINTENANCE REQUIREMENTS:**

- Inspect regularly
- Remove debris or other obstructions so as not to diminish flow capacity
- Repair damage from storms or normal construction activities such as tire ruts

### TARGETED POLLUTANTS

- Sediment
- Nutrients & Toxic Materials
- Oil & Grease
- Floatable Materials
- Other Construction Waste

### APPLICATIONS

- Perimeter Control
- Slope Protection
- Sediment Barrier
- Channel Protection
- Temporary Stabilization
- Final Stabilization
- Waste Management
- Housekeeping Practices

**Fe=0.95**

### IMPLEMENTATION CONSIDERATIONS

- Capital Costs
- Maintenance
- Training
- Suitability for Slopes > 5%

**Other Considerations:**

- None

### 2.4.1 Primary Use

The primary use of interceptor swales is to prevent erosion by diverting runoff around disturbed areas and steep slopes. The interceptor swale can either be used to direct sediment-laden flow from disturbed areas into a sediment control or to direct 'clean' runoff from upslope areas around the disturbed areas. Since the swale is easy to install during early grading operations, it can serve as the first line of defense in reducing sediment by reducing runoff across disturbed areas. An interceptor swale reduces the requirements for structural measures to capture sediment from runoff, since the volume of runoff is reduced. By intercepting sediment laden flow downstream of the disturbed area, runoff can be directed into a sediment basin or other control for sedimentation as opposed to long runs of silt fence or other filtration method.

### 2.4.2 Applications

Common applications for interceptor swales include roadway projects, site development projects with substantial offsite flow onto the construction site, and sites with a large area(s) of disturbance. The swale can be used in conjunction with diversion dikes to intercept flows. Temporary swales can be used throughout the project to direct flows away from staging, storage, and fueling areas to minimize the potential for construction materials and wastes to come into contact with runoff.

Runoff from disturbed areas that flows into a swale and flows within unstabilized (bare soil) swales must be routed into a sediment control such as a sediment basin. Dikes can also be used to direct runoff from disturbed areas to a filtration device, passive treatment system, or active treatment system when these are necessary to attain required levels of sediment removal.

Vegetated swales are an effective final stabilization technique if used to permanently direct flows around steep, easily eroded, slopes. The vegetation in the swale also effectively filters both sediment and other pollutants while reducing erosion potential.

### 2.4.3 Design Criteria

- Design calculations are required for the use of this control. The designer shall provide drainage computations, channel shape, channel dimensions, and channel slopes for each application.
- The maximum contributing drainage area should be 5 acres or less depending on site conditions.
- Maximum depth of flow in the swale shall be 1.5 feet based on a 2-year, 24-hour design storm. Positive overflow must be provided to accommodate larger storms.
- For permanent swales, the 1.5 feet maximum depth can be increased as long as provisions for public safety are implemented.
- The maximum contributing drainage area should be 5 acres or less depending on site conditions.
- Channels may be trapezoidal, parabolic, or v-shaped; however v-shaped channels may be difficult to stabilize, so they are generally used only where the volume and rate of flow is low.
- Side slopes of the swale shall be 3:1 or flatter.
- Side slopes of the interceptor swale may be 2:1 for swales to be used less than 3 months if flows in the swale are directed to a sediment control.
- Minimum design channel freeboard shall be 6 inches.
- For grades less than 2 percent and velocities less than 6 feet per second, the minimum required channel stabilization shall be grass, erosion control blankets or anchored mulch. For grades in excess of 2 percent or velocities exceeding 6 feet per second, stabilization is required in the form of turf reinforcement mats (or riprap with appropriate size, gradation, and thickness depending on flow conditions). Velocities greater than 8 feet per second will require approval by the local municipality and is discouraged.

- Refer to [Section 2.9 Vegetation](#) for design criteria and guidance on establishing vegetation in the swale.
- Check dams can be used to reduce velocities in steep swales. See [Section 2.1 Check Dam](#) for design criteria.
- Interceptor swales must be designed for flow capacity based on Manning's Equation to ensure a proper channel section. Alternate channel sections may be used when properly designed and accepted.
- Consideration must be given to the possible impact that any swale may have on upstream or downstream conditions.
- The outlet (discharge point) of the swale shall be designed to have non-erosive velocities or designed with velocity dissipation devices.
- Diverted runoff from a disturbed area or other construction activity shall be conveyed to a sediment-trapping device.
- A diversion dike may be used with an interceptor swale. Refer to [Section 2.2 Diversion Dike](#) for dike design criteria.

#### **2.4.4 Design Guidance and Specifications**

Specifications for construction of this item may be found in the Standard Specifications for Public Works Construction – North Central Texas Council of Governments, Section 201.6 Interceptor Swale.

#### **2.4.5 Inspection and Maintenance Requirements**

Swales should be inspected regularly (at least as often as required by the TPDES Construction General Permit) to locate and repair any damage to the channel or to clear debris or other obstructions so as not to diminish flow capacity. Damage from storms or normal construction activities such as tire ruts or disturbance of swale stabilization shall be repaired as soon as practical. Accumulated sediment deposited from water in the swale should be removed regularly to maintain the hydraulic capacity of the swale.

#### **2.4.6 Example Schematics**

The following schematics are example applications of the construction control. They are intended to assist in understanding the control's design and function.

The schematics are **not for construction**. They may serve as a starting point for creating a construction detail, but they must be site adapted by the designer. In addition, dimensions and notes appropriate for the application must be added by the designer.

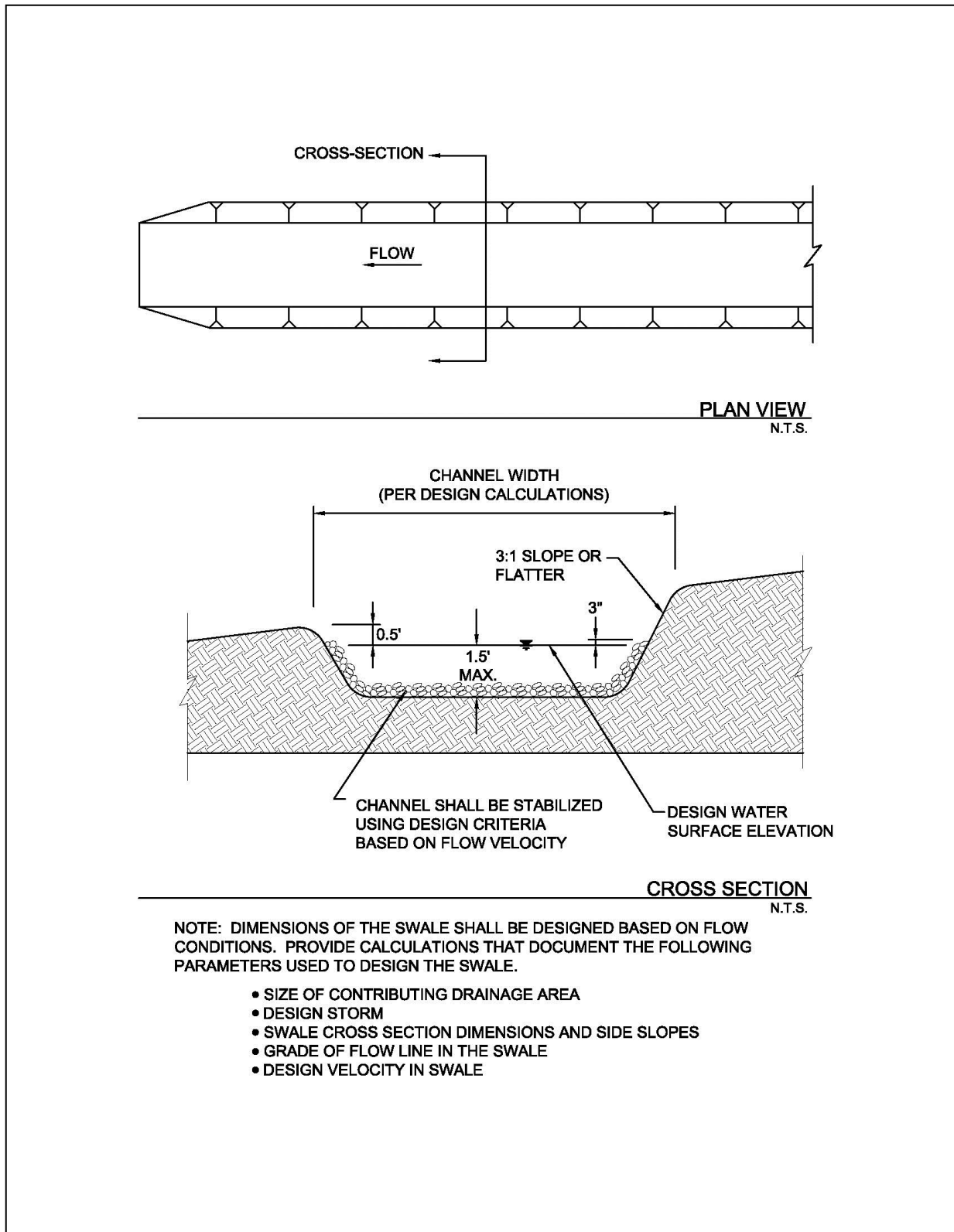
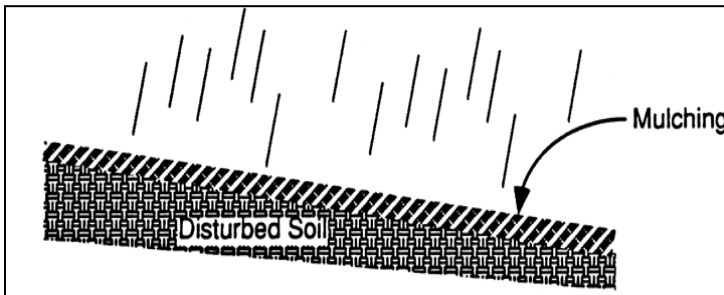


Figure 2.9 Schematics of Interceptor Swale

## 2.5 Mulching

Erosion Control



**Description:** Mulching is the application of a uniform layer of organic material over barren areas to reduce the effects of erosion from rainfall. Types of mulch include compost mixtures, straw, wood chips, bark, or other fibers. Commercialized surface treatments that combine straw or other mulch material with organic or inorganic soil binding systems are also available and are particularly useful on steep slopes.

### KEY CONSIDERATIONS

**DESIGN CRITERIA:**

- Specify even, uniform application
- Thickness of 1 to 2 inches, depending on application
- Application criteria specific to type of mulch
- Anchor mulch on slopes of 3:1 to 1.5:1
- Do not use mulch on slopes steeper than 1.5:1

**ADVANTAGES / BENEFITS:**

- Provides immediate stabilization of bare areas
- May be used with seeding for final stabilization
- Decreases soil moisture loss
- Decreases velocity of sheet flow
- Reduces volume of sediment-laden flow

**DISADVANTAGES / LIMITATIONS:**

- Subject to removal by wind or water
- Results in lower soil temperature, which may yield longer seed germination periods
- Should not be applied within the ordinary high-water mark of natural surface waters or within the design flow depth of constructed ditches and channels

**MAINTENANCE REQUIREMENTS:**

- Inspect regularly
- Replace regularly in high traffic areas to maintain uniform thickness
- Maintain a stockpile of excess mulch at the site to repair problem spots

### TARGETED POLLUTANTS

- Sediment
- Nutrients & Toxic Materials
- Oil & Grease
- Floatable Materials
- Other Construction Wastes

### APPLICATIONS

**Perimeter Control**

**Slope Protection**

**Sediment Barrier**

**Channel Protection**

**Temporary Stabilization**

**Final Stabilization**

**Waste Management**

**Housekeeping Practices**

**Fe=0.75-0.90**

*(Depends on coverage)*

### IMPLEMENTATION CONSIDERATIONS

- Capital Costs
- Maintenance
- Training
- Suitability for Slopes > 5%

**Other Considerations:**

- *Availability of materials for mulch*
- *Application depends on slope*

### 2.5.1 Primary Use

Mulch may be used by itself to temporarily stabilize bare areas or with seed to establish final stabilization of bare areas. Mulch protects the soil from erosion and moisture loss by lessening the effects of wind, water, and sunlight. It also decreases the velocity of sheet flow, thereby reducing the volume of sediment-laden water flow leaving the mulched area.

### 2.5.2 Applications

Mulch may be applied on most areas disturbed by construction that require surface protection including:

- Freshly seeded or planted areas;
- Disturbed areas at risk of erosion due to the time period being unsuitable for growing vegetation;
- Disturbed areas that are not conducive to vegetation for temporary stabilization; or
- Steep slopes of 3:1 to 1.5:1, provided the mulch is anchored to the soil by use of soil stabilizers, netting, or crimping.

Mulch is frequently applied with seeding for vegetation. In these cases, refer to [Section 2.9 Vegetation](#) for related criteria that may affect mulching.

Mulch may also be applied with commercially available polymers for soil surface treatment to bind the mulch with the soil. This method is particularly useful on steep slopes. Related criteria are available in [Section 2.7 Soil Surface Treatments](#).

### 2.5.3 Design Criteria

#### General

- Specific design information is required for the use of this control. The designer shall specify the type of mulch to be used, the application rate and/or thickness, and the type of anchoring (if applicable) based on site conditions.
- Choice of mulch depends largely on slope and soil type, in addition to availability of materials.
- Netting, adhesive polymers, or other methods of anchoring the mulch are required on slopes of 3:1 to 1.5:1. Do not use mulch on slopes steeper than 1.5:1.
- Mulch should be applied in an even and uniform manner where concentrated water flow is negligible. Do not apply mulch within the ordinary high-water mark of natural surface waters or within the design flow depth of constructed ditches and channels.
- Hay should not be used as mulch.
- Organic mulches may be distributed by hand or by mechanical means, provided a uniform thickness is achieved.
- When mulch is used with vegetation for final stabilization, fertilization and soil treatment for vegetation establishment should be done prior to placement of mulch, with the exception of hydroseeding or when seed is distributed following straw mulch spread during winter months.
- Table 2.1 on the following page contains a summary of mulch types and general guidelines.

<b>Mulch Material</b>	<b>Quality Standards</b>	<b>Application Rates</b>	<b>Remarks</b>
Straw	Air-dried, free of mold and not rotten.  Certified Weed Free.	1.5 to 2 tons per acre	Cost-effective when applied with adequate thickness.  Straw must be held in place by crimping, netting, or soil stabilizer.
Chipped Site Vegetation	Should include gradation from fine to coarse to promote interlocking properties.  Must be free of waste materials such as plastic bags, metal debris, etc.	10 to 12 tons per acre	Cost-effective method to dispose of vegetative debris from site.  Best application is for temporary stabilization where construction will resume.  Use cautiously on areas where vegetation will be established, as wood chips will deplete soil nitrogen.
Erosion Control Compost (Wood Chip and Compost Mixture)	Shall meet the Physical Requirements in Table 1 of TxDOT Special Specification 1001.	Approx. 10 tons per acre	Special caution is advised regarding the source and composition of wood mulches.  Ensure compost is free of herbicides.  Ensure wood chips are from unpainted and untreated wood.
Hydraulic Mulch	Must not contain sawdust, cardboard, paper, paper byproducts, plastics, or synthetics.  No petroleum-based tackifiers.	Follow the manufacturer's recommendations.  Application rate increases with slope steepness.	May be particularly effective on slopes steeper than 3:1.  Ensure wood fibers are from unpainted and untreated wood.

## Straw Mulch

- Straw mulch shall be free of weed and grass seed.
- Straw mulch shall be air-dried, free of mold, and not rotten.
- Straw fibers shall be a minimum of 4 inches and a maximum of 8 inches in length.
- Straw mulch must be anchored by using a tractor-drawn crimper to punch into the soil, by placing degradable netting above the mulch, or by application of a soil stabilizer (*Section 2.7 Soil Surface Treatments*).

## Chipped Site Vegetation

- Chipped site vegetation is suitable mulch for temporary stabilization before construction will resume in an area of the construction site.
- Ensure the cleared vegetation is free of trash, litter, and debris prior to chipping.

- Chipped pieces shall be a minimum of 2 inches and a maximum of 6 inches in length.
- Chipped woody vegetation that is greater than 50% wood chips by volume may result in mulch that depletes nitrogen in the soil. It is useful as mulch for temporary stabilization where construction activity will resume and result in removal of the mulch. However, it should be used with care on areas where vegetation will be established for final stabilization.
- Chipped vegetation that is greater than 50 percent wood chips by volume may require treatment with a nitrogen fertilizer when used for mulch with seeding.
- Chipped vegetation that includes green matter will include seeds. It should not be used on areas that have specific landscaping requirements.

### **Erosion Control Compost (Wood Chip and Compost Mixture)**

- Wood chip and compost mixture used for mulch shall meet the criteria for Erosion Control Compost in TxDOT Special Specification 1001.
- Wood chips for the mixture shall be less than or equal to 5 inches in length with 95 percent passing a 2 inch screen and less than 30 percent passing a 1 inch screen. Mulch should not contain chipped manufactured boards or chemically treated wood such as particleboard, railroad ties, or similar treated wood.
- Compost for the mixture shall meet the Physical Requirements specified in Table 1 of 2004 TxDOT Special Specification 1001, Compost. It must be free of herbicides and other chemicals.
- Mixing of the Erosion Control Compost into the soil surface is allowed when vegetation is established for final stabilization, except for drill seeding, in which case it is best to leave the mulch as an undisturbed top layer.

### **Hydraulic Mulch (Including Bonded Fiber Matrix)**

- Hydraulic mulch shall consist of a mixture of shredded wood fiber and a stabilizing binder. The mulch must not contain sawdust, cardboard, paper or paper byproducts.
- Shredded wood fiber shall be long strand, whole wood fibers that are:
  - Minimum of 25 percent of fibers 3/8 inch long;
  - Minimum of 50 percent held on a No. 25 sieve;
  - Free from paint, printing ink, varnish, petroleum products, seed germination inhibitors; and
  - Free from synthetic or plastic materials.
- Mulch binders may be organic or inorganic polymers. Asphaltic emulsions and other petroleum-based tackifiers shall not be used.
- The stabilizing emulsion must be nonflammable, non-toxic to aquatic organisms, and free from growth or germination inhibiting factors.
- Areas hydraulically mulched shall be protected from all traffic, including foot traffic, a minimum of 24 hours to allow the mulch to dry and cure. Depending on the mulch, up to 48 hours of protection may be required. Always follow manufacturer's recommendations.
- Hydraulic mulch provides limited to no protection until cured. Do not apply when rain is forecast within the next 24 hours.
- Hydraulic mulch may be particularly effective on slopes steeper than 3:1.

## **2.5.4 Design Guidance and Specifications**

Specifications for construction of this item may be found in the Standard Specifications for Public Works Construction – North Central Texas Council of Governments, Section 201.16 Mulching. Specifications for



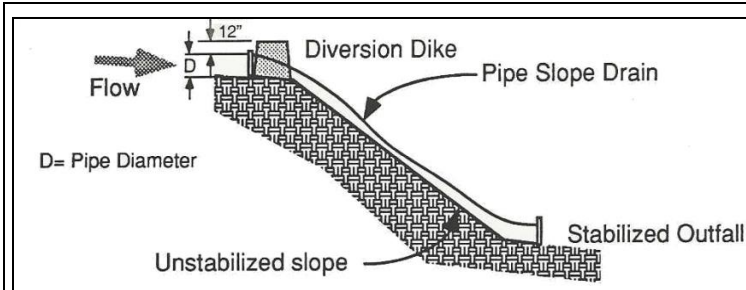
compost may be found in Standard Specifications for Construction and Maintenance of Highways, Streets and Bridges (TxDOT 2004) Item 161.

### *2.5.5 Inspection and Maintenance Requirements*

Mulched areas should be inspected regularly (at least as often as required by the TPDES Construction General Permit) for thin or bare spots caused by natural decomposition or weather related events. Mulch in high traffic areas should be replaced on a regular basis to maintain uniform protection. Excess mulch should be brought to the site and stockpiled for use during the maintenance period to dress problem spots.

## 2.6 Pipe Slope Drain

Erosion Control



**Description:** A pipe slope drain is a temporary or permanent pipeline, typically utilizing flexible pipe that conveys runoff down steep or unstabilized slopes without causing erosion. The drain is anchored on the upstream end with some form of headwall to limit erosion and secure the pipe.

**KEY CONSIDERATIONS**

**DESIGN CRITERIA:**

- Maximum entrance grade of 3 percent
- Anchor upstream end with a headwall or similar device
- Secure pipe with hold down anchors spaced 10 feet on center
- Stabilize outlet and provide velocity dissipation so that released flow has a velocity less than 3 feet per second

**ADVANTAGES / BENEFITS:**

- Protects slopes from erosion caused by overland flow
- A series of pipes may be used to control drainage areas greater than 5 acres in size

**DISADVANTAGES / LIMITATIONS:**

- Drain can easily be damaged by construction traffic
- Difficult to secure pipe to the slope
- Can become clogged during large rain events causing water to overflow and create a serious erosion condition

**MAINTENANCE REQUIREMENTS:**

- Inspect regularly
- Repair damage to pipe joints
- Unclog pipe

**TARGETED POLLUTANTS**

- Sediment
- Nutrients & Toxic Materials
- Oil & Grease
- Floatable Materials
- Other Construction Wastes

**APPLICATIONS**

Perimeter Control

**Slope Protection**

Sediment Barrier

Channel Protection

Temporary Stabilization

Final Stabilization

Waste Management

Housekeeping Practices

**Fe=0.95**

**IMPLEMENTATION CONSIDERATIONS**

- Capital Costs
- Maintenance
- Training
- Suitability for Slopes > 5%

**Other Considerations:**

- *Normally used in combination with interceptor swales or diversion dikes to direct flow*
- *Additional measures needed to remove sediment from runoff*

### 2.6.1 Primary Use

Pipe slope drains are used to protect graded slopes during establishment of temporary and final vegetation. They are used on sites with a long, unstabilized, steep slope area that is subject to erosion from overland flow. Drains are normally used in combination with interceptor swales or diversion dikes to direct the flow into the pipe. The pipe slope drain can provide service for a relatively large area. It does not treat the runoff; therefore if the runoff contains sediment from a disturbed area, treatment through a sediment control is required before the flow is released offsite.

### 2.6.2 Applications

Sites with large berms or grade changes, such as roadway embankments, are candidates for a pipe slope drain. Since provisions must be made to direct the flow into the pipe drain, some grading is normally required upstream of the pipe slope drain. Installed properly, slope erosion can be greatly reduced (but not entirely eliminated) through the use of the drain.

Pipe slope drains also require a stabilized outlet. This is critical since the velocities at the outfall are normally high. Velocity dissipators such as stone or concrete riprap are typically required to reduce the velocity and spread the flow, reducing erosion.

### 2.6.3 Design Criteria

- Design calculations and information are required for the use of this control. The designer shall provide drainage computations, pipe material, pipe size, and stone apron size for each application.
- The entrance to the pipe slope drain may be a standard corrugated, metal pre-fabricated, flared end section with an integral toe plate extending a minimum of 6 inches from the bottom of the end section.
- The grade of the entrance shall be 3 percent maximum.
- The diversion dike at the entrance shall have a minimum height of the pipe diameter plus 12 inches and a minimum width of 3 times the pipe diameter. Additional criteria are in [Section 2.2 Diversion Dike](#).
- The drain pipe shall be made of any material, rigid or flexible, capable of conveying runoff. Regardless of material, the drain pipe shall be completely water-tight so that no water leaks onto the slope being protected.
- All sections of the pipe slope drain shall be connected using watertight collars or gasketed watertight fittings.
- If the upslope drainage area contributing flow to the pipe drain is disturbed or the collection swale/dike for the drain is not stabilized, flow from a pipe slope drain must be routed to a sediment control to remove suspended soil collected in these areas before being discharged from the site.
- The pipe shall be secured with hold down anchors spaced 10 feet on center.
- Temporary pipe slope drains are to be sized to accommodate runoff flows equivalent to a 10-year storm as calculated using the Rational Method and Manning's equation, but in no case shall pipes be sized smaller than shown on the following table.

<i>Minimum Pipe Size</i>	<i>Maximum Contributing Drainage Area</i>
12 inches	0.5 Acres
18 inches	1.5 Acres
21 inches	2.5 Acres
24 inches	3.5 Acres
30 inches	5.0 Acres

- Maximum drainage areas for individual pipe slope drains shall be 5 acres. For areas larger than 5 acres, additional drains shall be added.
- Both the entrance and outfall of the pipe slope drain should be properly stabilized. Grass can normally be used at the entrance, but armor type stabilization such as stone or concrete riprap is normally required to address the high velocities of the outfall.
- A riprap lined apron shall be excavated to accept the discharge from the pipe and dissipate the energy of the flow. The width of the bottom of the apron shall be 3 times the pipe diameter, and the length shall be a minimum of 6 times the pipe diameter of the drain pipe.
- The riprap apron shall be a minimum of 12 inches in depth and shall be lined with well graded stone weighing between 50 and 150 pounds per stone at a minimum thickness of 12 inches. The top of the riprap apron shall be relatively flat (no slope) and flush with the surrounding ground.
- The apron shall be designed so that the released flow has a velocity less than 3 feet per second.

### *2.6.4 Design Guidance and Specifications*

Specifications for construction of this item may be found in the Standard Specifications for Public Works Construction – North Central Texas Council of Governments, Section 201.14 Pipe Slope Drain and in the Standard Specifications for Construction and Maintenance of Highways, Streets and Bridges (TxDOT 2004) Item 506.2.B and 506.4.C.2.

### *2.6.5 Inspection and Maintenance Requirements*

Pipe slope drains should be inspected regularly (at least as often as required by the TPDES Construction General Permit) to locate and repair any damage to joints or clogging of the pipe. In cases where the diversion dike has deteriorated around the entrance of the pipe, it may be necessary to reinforce the dike with sandbags or to install a concrete collar to prevent failure. Signs of erosion around the pipe drain should be addressed in a timely manner by stabilizing the area with erosion control blanket, turf reinforcement mats, riprap, concrete, or other acceptable methods.

### *2.6.6 Example Schematics*

The following schematics are example applications of the construction control. They are intended to assist in understanding the control's design and function.

The schematics are **not for construction**. They may serve as a starting point for creating a construction detail, but they must be site adapted by the designer. In addition, dimensions and notes appropriate for the application must be added by the designer.

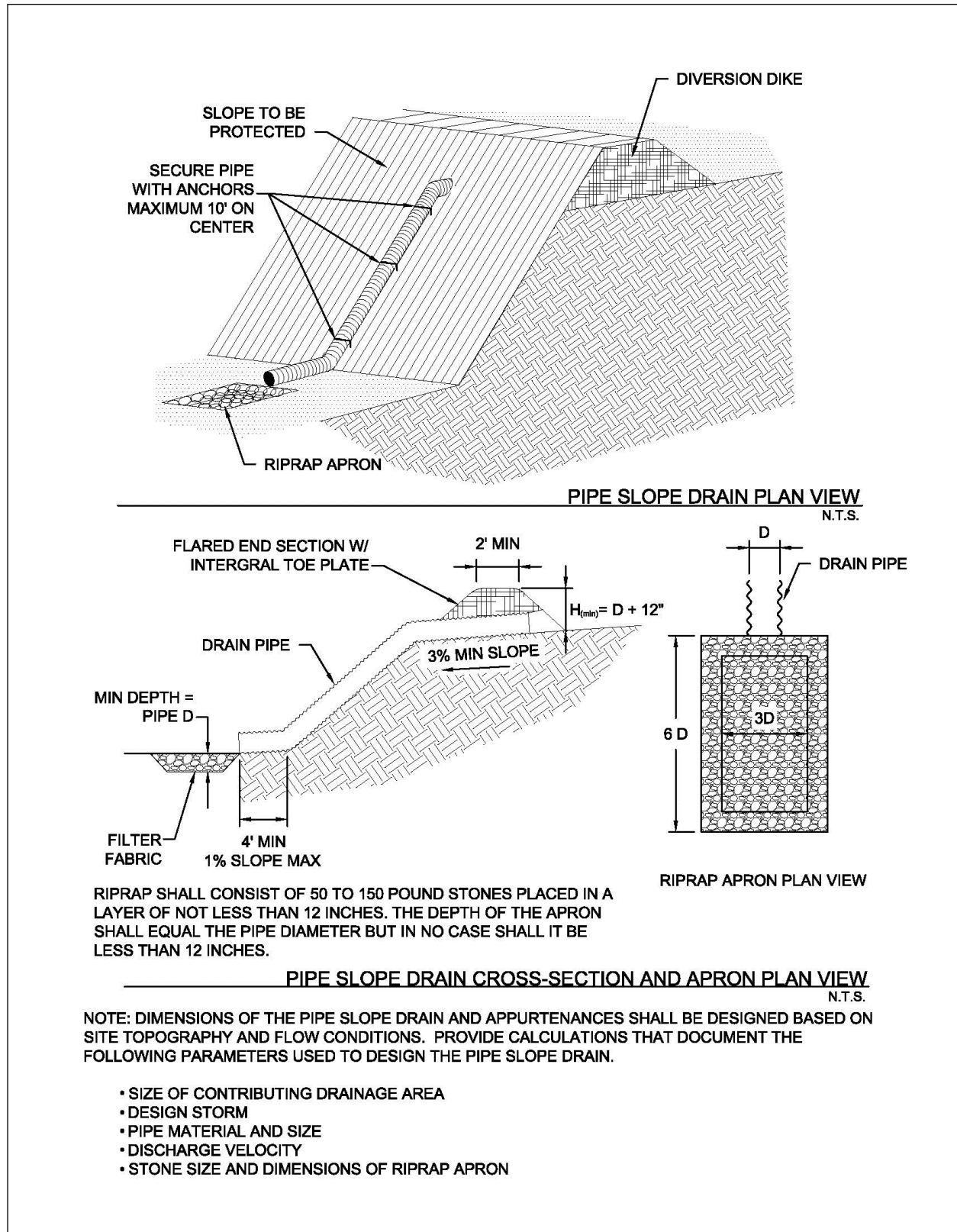
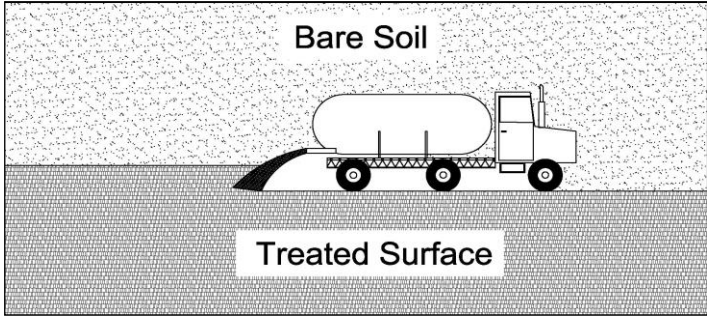


Figure 2.10 Schematics of Pipe Slope Drain

## 2.7 Soil Surface Treatments

Erosion Control

 <p style="text-align: center;"><b>Bare Soil</b></p> <p style="text-align: center;"><b>Treated Surface</b></p>	<p><b>Description:</b> Soil surface treatments are measures applied to a bare soil surface to temporarily decrease the amount of soil lost to wind and water erosion. Substances typically applied to the soil surface are water and organic and inorganic palliatives. Soil surface treatments are also effective for the surfaces of temporary berms and stockpiles.</p>
<p style="text-align: center;"><b><u>KEY CONSIDERATIONS</u></b></p> <p><b>DESIGN CRITERIA:</b></p> <ul style="list-style-type: none"> <li>• Maintain the original ground cover as long as practical</li> <li>• Select treatment method based on soil type, site conditions, and required duration of effectiveness</li> <li>• Control traffic on areas being treated</li> <li>• Apply water before start of work and repeat regularly</li> <li>• Select, dilute and apply palliatives according to manufacturer's recommendations</li> </ul> <p><b>ADVANTAGES / BENEFITS:</b></p> <ul style="list-style-type: none"> <li>• Prevents onsite and off-site impacts of dust deposition on roadways, drainage ways, or surface waters</li> </ul> <p><b>DISADVANTAGES / LIMITATIONS:</b></p> <ul style="list-style-type: none"> <li>• Sediment controls are still needed with soil surface treatments</li> <li>• Effectiveness is temporary</li> <li>• Control methods often require repeated applications</li> <li>• Water has limited effectiveness on soils in wind erodibility groups 1 – 4 and 4L</li> </ul> <p><b>MAINTENANCE REQUIREMENTS:</b></p> <ul style="list-style-type: none"> <li>• Inspect regularly</li> <li>• Reapply water and palliatives as needed</li> </ul>	<p style="text-align: center;"><b><u>APPLICATIONS</u></b></p> <p><b>Perimeter Control</b></p> <div style="border: 1px solid black; padding: 2px; margin-bottom: 5px;"><b>Slope Protection</b></div> <p><b>Sediment Barrier</b></p> <p><b>Channel Protection</b></p> <div style="border: 1px solid black; padding: 2px; margin-bottom: 5px;"><b>Temporary Stabilization</b></div> <p><b>Final Stabilization</b></p> <p><b>Waste Management</b></p> <p><b>Housekeeping Practices</b></p> <p style="text-align: center;"><b>Fe=0.10-0.90</b> <i>(Depends on type of treatment)</i></p>
<p style="text-align: center;"><b><u>TARGETED POLLUTANTS</u></b></p> <ul style="list-style-type: none"> <li>● Sediment</li> <li>○ Nutrients &amp; Toxic Materials</li> <li>○ Oil &amp; Grease</li> <li>○ Floatable Materials</li> <li>○ Other Construction Wastes</li> </ul>	<p style="text-align: center;"><b><u>IMPLEMENTATION CONSIDERATIONS</u></b></p> <ul style="list-style-type: none"> <li>● Capital Costs</li> <li>● Maintenance</li> <li>● Training</li> <li>● Suitability for Slopes &gt; 5%</li> </ul> <p><b>Other Considerations:</b></p> <ul style="list-style-type: none"> <li>• <i>Worker protection for mixing, dilution, and application of some palliatives</i></li> </ul>

### 2.7.1 Primary Use

Surface treatments are used to reduce wind and water erosion by providing temporary stabilization of bare soil. They are primarily used where stabilization is needed for less than 12 months.

### 2.7.2 Applications

Soil surface treatments are applicable to any construction site where dust is created and there is the potential for air and water pollution from dust being blown off the site. The treatments are applicable to bare areas of soil, temporary soil berms, stockpiles, earth-moving activities, and demolition activities, all of which can be sources of dust.

The National Resources Conservation Service (NRCS) assigns a wind erodibility group to soils as shown in Table 2.3.

<b>Group</b>	<b>Soil Type</b>	<b>Erosion Potential</b>
1	Sands, coarse sands, fine sands and very fine sands	Extremely erodible
2	Loamy sands, loamy fine sands, and loamy very fine sands	Very highly erodible
3	Sandy loams, coarse sandy loams, fine sandy loams, and very fine sandy loams	Highly erodible
4L	Calcareous loamy soils that are less than 35 percent clay and more than 5 percent finely divided calcium carbonate	Erodible
4	Clay, silty clays, clay loams and silty clay loams that are more than 35 percent clay	Moderately erodible
5	Loam soils that are less than 18 percent clay and less than 5 percent finely divided calcium carbonate and sandy clay loams and sandy clays that are less than 5 percent finely divided calcium carbonate	Slightly erodible
6	Loamy soils that are 18 to 35 percent clay and less than 5 percent finely divided calcium carbonate, except silty clay loams	Very slightly erodible
7	Silty clay loams that are less than 35 percent clay and less than 5 percent finely divided calcium carbonate	Slightly erodible
8	Stony or gravelly soils	Not subject to wind erosion

Soil surface treatments for dust control will be most applicable to soils in groups 1 through 4 and 4L. If the soil type is unknown, the native soil type(s) at a site can be identified on the NRCS Web Soil Survey at: <http://websoilsurvey.nrcs.gov/app/>. The website also provides the wind erodibility group for native soils.

Consider the depth of grading activities when determining the applicable surface treatments. Soil type varies with depth. The surface soil may have low potential for wind erosion, but the soil at a lower depth may be highly erodible when it is exposed by grading operations.

### 2.7.3 Design Criteria

#### General

- The first design criterion for soil surface treatments is to minimize the area of disturbed soil that requires treatment.

- Limit clearing and grading to the areas of the site required for the immediate phase of construction. For larger sites, plan the work to be phased such that the total disturbed area is less than 10 acres at all times. If possible, design the site layout and grading to allow for street and utility construction without having to grade the entire site to balance cut and fill.
- Selection of the surface treatment should consider the length of time for which stabilization is needed.
- Natural (e.g. trees) windbreaks or artificial wind screens can be designed into the site to decrease wind erosion potential. Wind screens should be 3 to 5 feet in height. Porosity of the wind screens should be a minimum of 20 percent. Optimum performance is in the 40 percent to 60 percent porosity range.
- Wind screens should never be impermeable. The purpose of the screen is to disrupt the wind, not block it.
- Wind screens placed around stockpiles shall enclose three sides of the stockpile.

## Water Treatments

- Water treatment shall be used only for decreasing wind erosion. It provides no protection from erosion due to stormwater runoff.
- Water treatment is appropriate for areas that are worked daily or at least as frequently as every week or two. Areas where construction activities will not occur for more than 14 days shall receive another type of surface treatment, such as a palliative, vegetation, or other treatment that provides temporary stabilization and protection from water erosion.
- Water shall be applied 15 to 20 minutes before start of work and re-applied throughout the day as necessary to prevent visible emissions.
- At a minimum, sprinkle bare areas with an amount of water and at a rate that will moisten the top two inches of soil without creating runoff.
- When grading activities are occurring during prolonged dry and windy periods, sufficient water should be applied to moisten soil to the depth of cut or equipment penetration. This may require installing portable piping and sprinklers in advance of grading.
- If construction activities include installing an irrigation system, install it in early phases of construction, where feasible, to use for dust control.
- Water treatments provide limited stabilization against wind erosion and no stabilization against water erosion. Sediment controls are required with water treatments.

## Palliative Treatments

- Palliatives consist of liquids that react with soil particles and bonds them into a cohesive crust that provides temporary resistance to wind and water erosion. Palliative treatments are also called soil binders.
- The major groups of palliatives used for erosion control are polyacrylamide (PAM), guar-based (organic) compounds, and polyvinyl acetates (inorganic polymers). Numerous variations and mixes of these palliatives are available, each with its unique properties.
- Palliative treatments are appropriate for areas that require temporary stabilization for 3 to 12 months. Palliative treatments are highly effective in controlling wind erosion and moderately effective in controlling water erosion. Perimeter controls for sediment should remain in place until final stabilization.
- In general, areas stabilized with palliatives must be protected from traffic to be effective. Palliative treatments that can withstand traffic (pedestrian or vehicle) are available; however, they are more expensive. The designer should determine whether the site can be controlled to prevent traffic on the stabilized areas. This analysis should consider non-construction related traffic. Often, the public driving ATV's and bicycles on the site when construction is not active is the cause of stabilization



failure. In many cases, temporary chain-link fencing is less expensive than a palliative that can withstand traffic or re-applying a palliative to areas that have been disturbed.

- Selection of the palliative mix, dilution rate, and application rate should be based on the soil type, site conditions, climate, anticipated traffic on the treated area, and required duration of the stabilization.
- The designer should work with the supplier to develop a mix specific for the soil, climate, and site conditions. A successful application is highly dependent on the right proportions in the mix. An “off the shelf” mix should not be used.
- Palliatives are dependent on soil penetration to be effective. Compaction of soil prior to stabilization should be minimized. If compaction has occurred or the soil has high clay content, loosening of the surface may be necessary before applying the palliative.
- Do not apply palliatives in rainy conditions or when the soil has high moisture content. Verify that there is not rain in the forecast for the length of time recommended by the manufacturer to cure the palliative. Typically, a minimum of 24 hours is required.
- If the soil is excessively dry, pre-wetting may be necessary to ensure the palliatives do not cure too quickly.
- Palliative mixes may be supplied as a powder or a concentrated liquid. The designer should work with the supplier to establish exact dilution and application rates for the site. An application without enough water for the site and climate conditions will dry too quickly, and the soil particles will not bond properly. A too wet mix will result in a weaker bond that may not be sustained for the required duration of the stabilization.
- Palliatives should not be diluted until it is time for the palliative to be applied.
- Palliatives may be applied with mulch to stabilize slopes of 3:1 to 1.5:1. Additional criteria are in [Section 2.5 Mulching](#).
- Palliatives may be mixed and applied with seed to establish vegetation. The palliative mix used for this application must be specified as one that is air and water permeable. The palliative will provide temporary stabilization until vegetation is established for final stabilization.

## Vegetation Treatments

- If an area will not be disturbed by construction activities for a year or longer, vegetation is frequently the most cost-effective treatment.
- [Section 2.9 Vegetation](#) contains criteria for temporary stabilization with vegetation.

## Other Treatments

- Gravel, recycled concrete or asphalt, or similar rock should be applied to temporary roads, contractor staging areas, employee parking lots and other portions of the site that receive daily traffic. The treatment will prevent dust and decrease the need for sediment controls on these areas during the duration of the construction project.
- Soil roughening, by driving tracked vehicles up and down slopes and across bare areas in irregular patterns, can be used to disrupt wind and water flow across the soil surface and decrease erosion for short periods of time. The track marks should be perpendicular to the predominate direction of water flow or wind.
- Similar to soil roughening, deep tillage (6 to 12 inches) in large open areas can significantly disrupt wind and drainage patterns to reduce erosion.
- Do not use “soil tackifiers” that are petroleum-based.

### *2.7.4 Design Guidance and Specifications*

No specification for soil surface treatments is currently available in the Standard Specifications for Public Works Construction – North Central Texas Council of Governments.

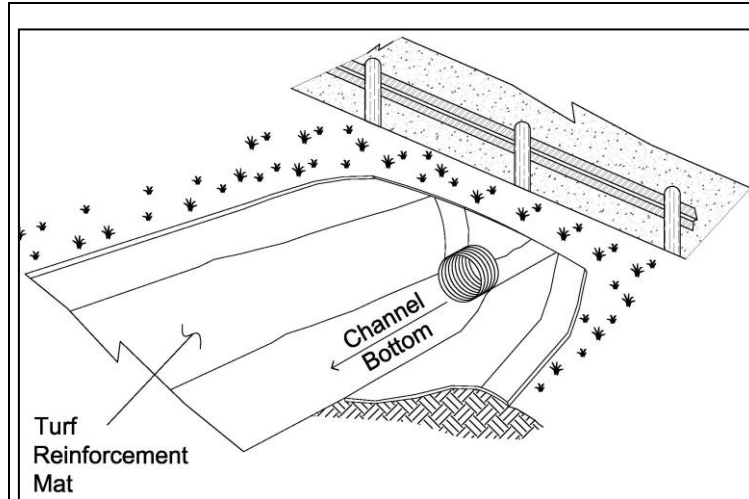
### *2.7.5 Inspection and Maintenance Requirements*

Soil surface treatments should be inspected regularly (at least as often as required by the TPDES Construction General Permit). Adequacy of watering for dust control should be visually monitored. If dust is observed, additional applications or different controls are needed.

Areas that have received a palliative treatment should be checked for breaks or eroded spots in the surface crust. This spots and areas that have been driven on or otherwise disturbed should be re-treated. Palliative treatments are intended to control sheet erosion. If rill erosion is detected during inspections, additional controls are needed.

## 2.8 Turf Reinforcement Mats

Erosion Control



**Description:** A turf reinforcement mat (TRM) is a long-term, non-degradable, rolled erosion control product that reduces soil erosion and assists in the establishment and growth of vegetation. TRMs, also known as flexible channel liners, are manufactured by many companies. They are composed primarily of UV stabilized, geosynthetic or geocomposite materials, netting and/or wire mesh, processed into a three dimensional reinforcement matrix. TRMs are designed to be permanent and for use in critical hydraulic conditions.

### KEY CONSIDERATIONS

**DESIGN CRITERIA:**

- Select TRM based on flow velocities and shear stresses in the channel
- Installation and anchoring according to manufacturer's recommendations

**ADVANTAGES / BENEFITS:**

- Provides long-term stabilization of channels with high velocities and shear stresses
- Retains soil in a 3-dimensional matrix that facilitates establishment of vegetation

**DISADVANTAGES / LIMITATIONS:**

- Expensive
- Effectiveness is highly dependent on proper installation

**MAINTENANCE REQUIREMENTS:**

- Inspect regularly
- Replace or re-anchor loosened mats

### TARGETED POLLUTANTS

- Sediment
- Nutrients & Toxic Materials
- Oil & Grease
- Floatable Materials
- Other Construction Wastes

### APPLICATIONS

**Perimeter Control**

**Slope Protection**

**Sediment Barrier**

**Channel Protection**

**Temporary Stabilization**

**Final Stabilization**

**Waste Management**

**Housekeeping Practices**

**Fe=0.90**

### IMPLEMENTATION CONSIDERATIONS

- Capital Costs
- Maintenance
- Training
- Suitability for Slopes > 5%

**Other Considerations:**

- *Long term maintenance*

### 2.8.1 Primary Use

Turf reinforcement mats (TRMs) are primarily used to provide temporary and final stabilization of channels where design discharges exert velocities and shear stresses that exceed the limits of mature vegetation. They are also used to stabilize steep slopes where it's difficult to establish vegetation.

### 2.8.2 Applications

TRMs provide long-term erosion protection in channels where flow conditions exceed the ability of vegetation alone to withstand erosive forces (grades in excess of 2 percent or velocities exceeding 6 feet per second). Turf reinforcement mats may provide channel protection for conditions of up to approximately 8 lbs/ft<sup>2</sup> shear stress.

TRMs may also be used for short lengths of steep cut/fill slopes on which establishment of vegetation is difficult. TRMs also contain void spaces that can retain soil that would erode without protection, and thus give vegetation a change to establish.

### 2.8.3 Design Criteria

- The designer shall specify the manufacturer, type of TRM to be used, and dimensioned limits of installation based on the site topography and drainage.
- The type and class of TRM must be specified in accordance with the manufacturer's guidance for the slope of the area to be protected, the flow rate (sheet flow on cut/fill slopes) or velocity (concentrated flow in swales) of stormwater runoff in contact with the TRM, shear stress, and the design life (duration) of the TRM.
- TRMs specified on projects should meet the applicable "Minimum Performance Standards for TxDOT" as published by TxDOT in its "Erosion Control Report." Alternatively, the TRM may be listed on the most current annual "Approved Products List for TxDOT" applicable to TxDOT Item 169 Soil Retention Mat and its Special Provisions.
- TRMs shall meet the following criteria when applied on slopes of 0.5:1 or flatter.
  - Minimum thickness of 0.25 inches using ASTM D6525 Standard Test Method for Measuring Nominal Thickness of Permanent Rolled Erosion Control Products.
  - UV stability of 80 percent at 500 hours using ASTM D4355 Standard Test Method for Deterioration of Geotextiles by Exposure to Light, Moisture and Heat in a Xenon Arc Type Apparatus.
  - Minimum tensile strength of 175 lbs/ft using ASTM D6818 Standard Test Method for Ultimate Tensile Properties of Turf Reinforcement Mats.
- TRMs shall be installed vertically down slope (across contours) on steep cut/fill slopes and embankments. In channels, TRMs shall be installed along the contours (parallel to flow) below the water surface elevation of the flood mitigation storm (100-year, 24-hour) and vertically across any steep slopes for high banks above the water surface elevation.
- On cut/fill slopes and channels designed to receive turf reinforcement mats for temporary or final stabilization, the installation of the TRMs shall be initiated immediately after completing grading of the slope or channel, and in no case later than 14 days after completion of grading these features. Do not delay installation of TRMs on these highly-erodible areas until completion of construction activities and stabilization of the remainder of the site.
- Prior to the installation of the TRM, all rocks, dirt clods, stumps, roots, trash and any other obstructions that would prevent the TRM from lying in direct contact with the soil shall be removed.
- Installation and anchoring shall conform to the recommendations shown within the manufacturer's published literature for the turf reinforcement mat. Anchors (staples) shall be a minimum of 6 inches in length and 1 inch wide. They shall be made of 8-gauge wire, or equivalent.

- The end of each TRM roll shall overlap the next end of the next roll by a minimum of 3 feet. Sides of rolls typically overlap a minimum of 4 inches.
- The perimeter of the TRM installation shall be anchored into a trench that is a minimum of 6 inches deep.
- The upstream end of TRMs used for channel protection shall be anchored a minimum of 12 inches, while the downstream end should be anchored 6 inches.
- Trenches shall be excavated for anchoring, followed by placement and tamping of fill on top of the mat.

### *2.8.4 Design Guidance and Specifications*

Specifications for this item may be found in Item 169 of the Standard Specifications for Construction and Maintenance of Highways, Streets and Bridges (TXDOT 2004).

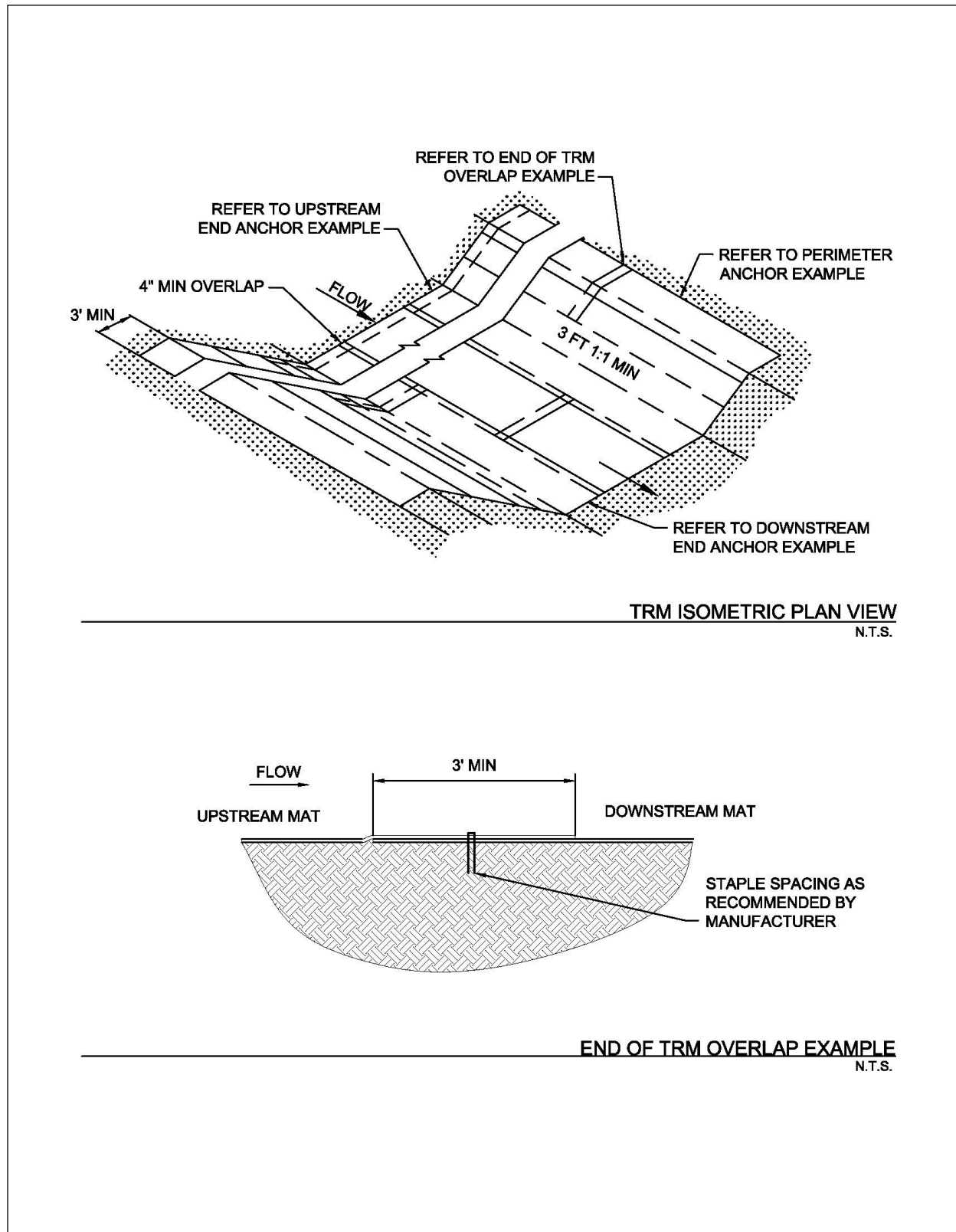
### *2.8.5 Inspection and Maintenance Requirements*

Turf reinforcement mats should be inspected regularly (at least as often as required by the TPDES Construction General Permit) for bare spots caused by weather or other events. The mats should be checked for uniform contact with the soil, security of the lap joints, and flushness of the staples with the ground. Missing or loosened mats must be replaced or re-anchored.

### *2.8.6 Example Schematics*

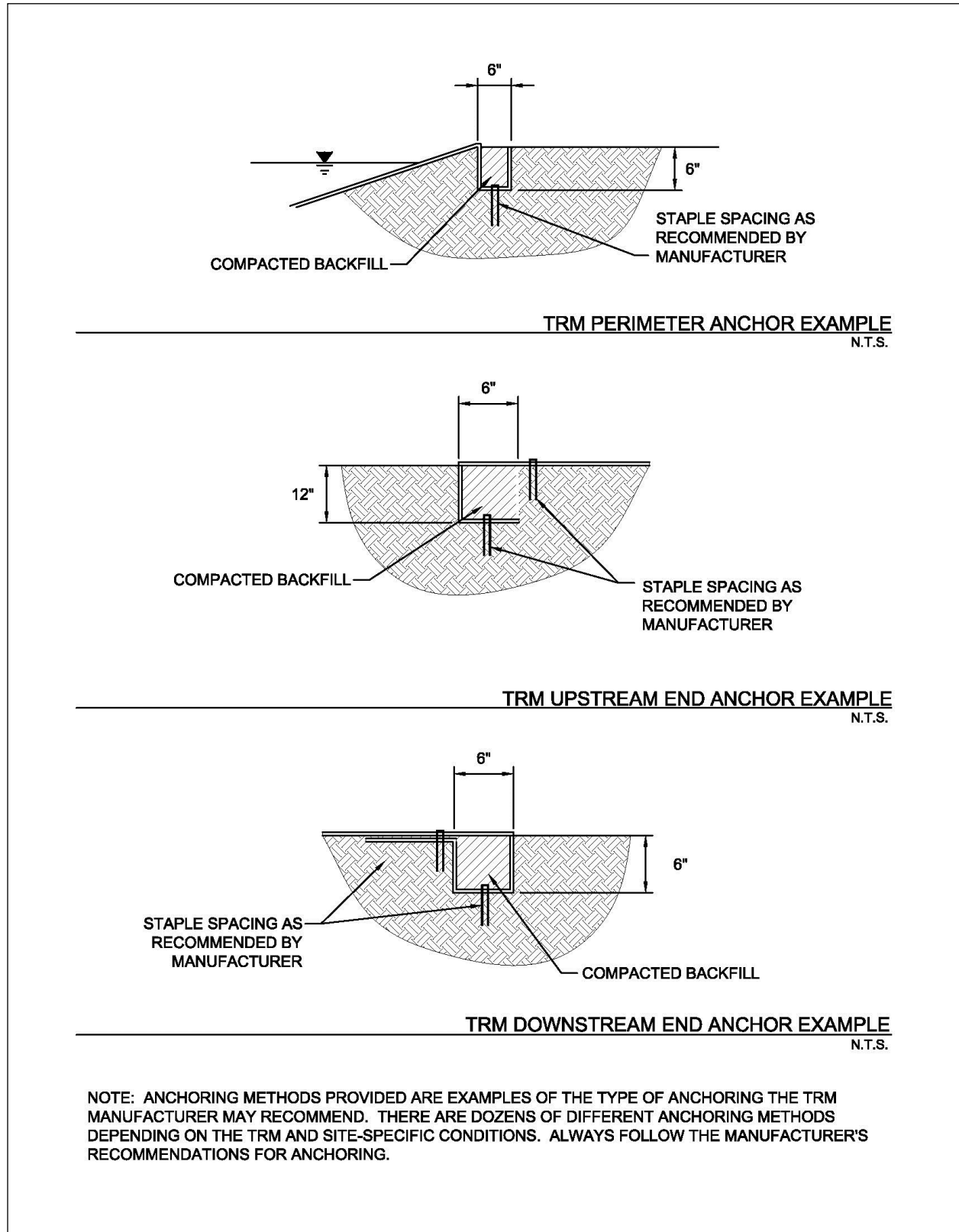
The following schematics are example applications of the construction control. They are intended to assist in understanding the control's design and function.

The schematics are **not for construction**. The designer is responsible for working with TRM manufacturers to ensure the proper TRM is specified based on the site topography and drainage. Installation measures should be dictated by the TRM manufacturer and are dependent on the type of TRM installed. Manufacturer's recommendations for overlap, anchoring, and stapling shall always be followed. Criteria shown here are applicable only when they are more stringent than those provided by the manufacturer.



**Figure 2.11 Schematics of Turf Reinforcement Mats**

(Sources: Modified from American Excelsior Company and Texas Department of Transportation)

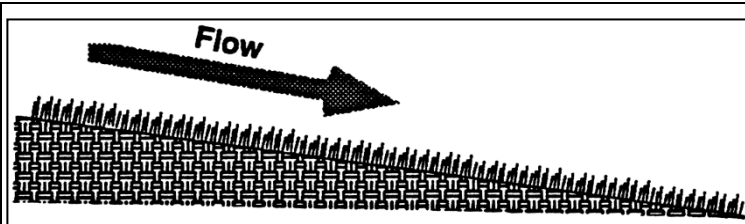


**Figure 2.12 Examples of Turf Reinforcement Mat Anchoring**

(Source: Modified from Texas Department of Transportation Soil Retention Blanket Product Installation Sheet)

## 2.9 Vegetation

Erosion Control



**Description:** Vegetation, used as an erosion control, is the sowing or sodding of grasses, small grains, or legumes to provide temporary and final vegetative stabilization for disturbed areas.

**KEY CONSIDERATIONS**

**DESIGN CRITERIA:**

- Specify preparation of the soil surface before seeding or sodding
- Minimum of 4 to 6 inches of top soil required, depending on subsurface conditions
- Specify soil amendments depending on soil conditions
- Select seed or sod species appropriate for the climate, season, and soil

**ADVANTAGES / BENEFITS:**

- More effective and easier to maintain than sediment controls during a long construction period
- May be used for temporary or final stabilization

**DISADVANTAGES / LIMITATIONS:**

- Not appropriate for areas with heavy pedestrian, vehicular traffic, or concentrated, high velocity flow
- May require days to weeks for adequate establishment
- Alternate erosion control is needed until vegetation is established

**MAINTENANCE REQUIREMENTS:**

- Inspect regularly
- Protect newly seeded areas from excessive runoff, high velocity flow, and traffic until vegetation is established
- Water and fertilize until vegetation is established
- Reseed and/or provide mulch or another control for bare spots
- Rake accumulations of sediment from the vegetation

**TARGETED POLLUTANTS**

- Sediment
- Nutrients & Toxic Materials
- Oil & Grease
- Floatable Materials
- Other Construction Wastes

**APPLICATIONS**

**Perimeter Control**

**Slope Protection**

**Sediment Barrier**

**Channel Protection**

**Temporary Stabilization**

**Final Stabilization**

**Waste Management**

**Housekeeping Practices**

**Fe=0.90**

*(When fully established; lower while vegetation is first growing)*

**IMPLEMENTATION CONSIDERATIONS**

- Capital Costs
- Maintenance
- Training
- Suitability for Slopes > 5%

**Other Considerations:**

- *Design is unique to soil and other conditions at each site*
- *Watering and other maintenance required until vegetation is established*



### 2.9.1 Primary Use

Vegetation is used as a temporary or final stabilization measure for areas disturbed by construction. As a temporary control, vegetation is used to stabilize stockpiles, earthen dikes, and barren areas that are inactive for longer than two weeks. As a final control at the end of construction, grasses and other vegetation provide good protection from erosion along with some filtering for overland runoff. Subjected to acceptable runoff velocities, vegetation can provide a positive method of long-term stormwater management as well as a visual amenity to the site.

Other control measures may be required to assist during the establishment of vegetation. These other controls include erosion control blankets, mulching, swales, and dikes to direct flow around newly seeded areas and proper grading to limit runoff velocities during construction.

### 2.9.2 Applications

Vegetation effectively reduces erosion in channels and swales and on stockpiles, dikes, and mild to medium slopes. Vegetative strips can provide some protection and sediment trapping when used as a perimeter control for utility and site development construction. Refer to [Section 3.15 Vegetated Filter Strips and Buffers](#) for more information.

In many cases, the initial cost of temporary seeding may be high compared to tarps or covers for stockpiles or other barren areas subject to erosion. This initial cost should be weighed with the amount of time the area is to remain inactive, since vegetation is more effective and the maintenance cost for vegetated areas is much less than most structural controls.

### 2.9.3 Design Criteria

#### General

- Vegetation is a highly effective erosion control when the vegetation is fully established. Until then, additional controls are needed. Sediment controls should not be removed from vegetated areas until the vegetation is established.
- On grades steeper than 20:1 (5 percent), anchored mulch or erosion control blankets are required to protect seeded areas until vegetation is established. Refer to [Section 2.5 Mulching](#) and [Section 2.3 Erosion Control Blankets](#) for design criteria.
- Vegetation may be used by itself for channel protection when the channel grade is less than 2 percent and the temporary control design storm (2-year, 24-hour) and the conveyance storm (25-year, 24-hour) flow velocities are less than 6 feet per second.
- If the velocity of the temporary control design storm is greater than 2 feet per second, erosion control blankets shall be used in the channel while vegetation is being established. Turf reinforcement mats are required when the velocity exceeds 6 feet per second. Refer to [Section 2.3 Erosion Control Blankets](#) and [Section 2.8 Turf Reinforcement Mats](#) for design criteria.
- Stabilization of channels with vegetation is limited to channels that have side slopes of 3:1 or flatter.
- On cut/fill slopes and channels designed to receive temporary or final vegetation, establishment of vegetation shall be initiated immediately after completing grading of the cut/fill slope or channel, and in no case later than 14 days after completion of grading on these features. It is not acceptable to delay establishing vegetation on these highly-erodible areas until completion of construction activities and stabilization of the remainder of the site.

#### Surface Preparation

- Unless infeasible, remove and stockpile existing topsoil at the start of grading activities. Store topsoil in a series of small stockpiles instead of one large stockpile to decrease the loss of aerobic soil micro-organisms during stockpiling.

- Interim or final grading must be completed prior to seeding or sodding.
- To minimize soil compaction of areas to be vegetated, limit vehicle and equipment traffic in these areas to the minimum necessary to accomplish grading.
- Install all necessary erosion structures such as dikes, swales, diversions, etc. prior to seeding or sodding.
- Spread stockpiled topsoil evenly over the disturbed area to be vegetated.
- Depth of topsoil shall be a minimum of 4 inches, with 6 inches required where the topsoil is over rock, gravel or otherwise unsuitable material for root growth. After spreading stockpiled topsoil, provide additional top soil as needed to achieve these depths.
- Compost Manufactured Topsoil as specified in TxDOT Special Specification 1001 may be used to achieve the specified depths or when it's infeasible to stockpile topsoil. Topsoil may also be acquired from another construction site if there is no space to stockpile the topsoil at that site.
- Topsoil shall have an organic content of 10 to 20 percent using ASTM D2974 Standard Test Methods for Moisture, Ash, and Organic Matter of Peat and Other Organic Soils.
- Topsoil that does not meet the organic content requirement shall be amended with General Use Compost as specified in TxDOT Special Specification 1001. Amendment should be three parts of topsoil to one part compost by volume thoroughly blended.
- Seed bed should be well pulverized and loosened to a minimum depth of 3 inches and then raked to have a uniform surface.
- When establishing vegetation from seed, groove or furrow slopes steeper than 3:1 on the contour line before seeding.

### **Plant Selection, Fertilization and Seeding**

- Use only high quality, USDA certified seed.
- Use an appropriate species or species mixture adapted to the local climate, onsite soil conditions and the season as shown below, or consult with the local office of the Natural Resource Conservation Service (NRCS) or Texas AgriLife Extension Service for selection of proper species and application technique in this area.
- Seeding rate should be in accordance with the Tables 2.4, 2.5 and 2.6 as follow in this section or as recommended by the Natural Resources Conservation Service (NRCS) or Texas AgriLife Extension Service.
- Chemical fertilization is not recommended at the time of seeding, because it typically stimulates and is consumed by fast growing weeds that out-compete the slower growing grasses and legumes. If the topsoil has not been amended by compost as discussed above, an 0.5 inch layer of General Use Compost (TxDOT Special Specification 1001) is recommended as a surface treatment to protect the seed and provide slow release nutrients
- Evenly apply seed using a seed drill, cultipacker, terraseeding, or hydroseeder.
- Hydro-seeding should not be used on slopes of 5:1 or steeper unless Bonded Fiber Matrix is used.
- Seeded areas shall be thoroughly watered immediately after planting. Water shall be applied at a rate that moistens the top 6 inches of soil without causing runoff. Provide water daily for the first 14 days after seeding and thereafter as needed to aid in establishment of vegetation.
- Use appropriate mulching techniques ([Section 2.5 Mulching](#)) where necessary, especially during cold periods of the year. Mulch consisting of chipped site vegetation is discouraged, since the wood content may result in depleting nitrogen from the soil.

## Sodding

- Use of sod should be limited to planned landscapes due to the relatively high water use of most types of sod grass.
- When sod is necessary to achieve immediate stabilization, buffalograss (*Buchloe dactyloides*) is recommended. Other types of sod may be used in landscaping when specified by a landscape architect for a commercial property or a homebuyer for a residential lot.
- The sod should be mowed prior to sod cutting so that the height of the grass shall not exceed 3 inches and should not be harvested or planted when its moisture condition is so excessively wet or dry that its survival shall be affected.
- Sod shall have a healthy, virile, system of dense, thickly matted roots throughout a minimum soil thickness of 0.75 inch.
- Sod shall be planted within 3 days after it is excavated.
- In areas subject to direct sunlight, pre-moisten prepared sod bed by watering immediately prior to placing sod.
- Sodded areas shall be thoroughly watered immediately after they are planted.

## Temporary Vegetation

The following table lists recommended plant species for the North Central Texas region depending on the season for planting.

<b>Season</b>	<b>Common Name</b>	<b>Pure Live Seed Rate (Lbs/Acre)</b>
Sep 1 - Nov 30	Tall Fescue	4.5
	Western Wheat Grass	5.6
	Wheat (Red, Winter)	34.0
May 1 - Aug 31	Foxtail Millet	34.0
Feb 15 – May 31 Sep 1 – Dec 31	Annual Rye	20.0

Areas receiving temporary seeding and vegetation shall be landscaped, re-seeded or sodded with perennial species to establish final vegetation at the end of construction.

## Vegetation for Final Stabilization

Sodding or seeding may be used to establish vegetation for final stabilization of areas disturbed by construction activity. The vegetation must achieve a cover that is 70 percent of the native background vegetative cover to be considered final stabilization. Sod will achieve this coverage quicker than seeding; however, sod is usually more expensive than seeding. Sod is most cost-effective for small areas or areas of concentrated flow or heavy pedestrian traffic where it will be difficult to establish vegetation by seeding.

Grass seed for establishing final stabilization can be sown at the same time as seeding for temporary (annual) vegetation. Drought tolerant native vegetation is recommended rather than exotics as a long-term water conservation measure. Native grasses can be planted as seed or placed as sod. Buffalo 609, for example, is a hybrid grass that is placed as sod. Fertilizers are not normally used to establish native grasses, but mulching is effective in retaining soil moisture for the native plants.

County	Planting Date	Clay Soils		Sandy Soils	
		Species and Pure Live Seed Rate (Lbs/Acre)		Species and Pure Live Seed Rate (Lbs/Acre)	
Erath Hood Johnson Palo Pinto Parker Somervell Tarrant Wise	February 1 – May 15	Green Sprangletop Sideoats Grama (El Reno) Bermudagrass Little Bluestem (Native) Blue Grama (Hachita) Illinois Bundleflower	0.3 2.7 0.9 1.0 0.9 1.0	Green Sprangletop Sand Lovegrass Bermudagrass Weeping Lovegrass (Ermelo) Sand Dropseed Partridge Peal	0.3 0.5 1.8 0.8 0.4 1.0
Collin Dallas Denton Ellis Kaufman Navarro Rockwell	February 1 – May 15	Green Sprangletop Bermudagrass Sideoats Grama (El Reno) Little Bluestem (Native) Buffalograss (Texoka) Illinois Bundleflower	0.3 1.2 2.7 2.0 1.6 1.0	Green Sprangletop Bermudagrass Weeping Lovegrass (Ermelo) Sand Lovegrass Sand Dropseed Partridge Pea	0.3 1.8 0.6 0.6 0.4 1.0
Hunt	February 1 – May 15	Green Sprangletop Sideoats Grama (El Reno) Bermudagrass Little Bluestem (Native) Illinois Bundleflower	0.3 3.2 1.8 1.7 1.0	Green Sprangletop Bermudagrass Bahagrass (Pensacola) Sand Lovegrass Weeping Lovegrass (Ermelo) Partridge Pea	0.3 1.5 6.0 0.6 0.8 1.0

(Source: TxDOT Standard Specifications for Construction and Maintenance of Highways, Streets and Bridges, Item 164)

County	Planting Date	Clay Soils		Sandy Soils	
		Species and Pure Live Seed Rate (Lbs/Acre)		Species and Pure Live Seed Rate (Lbs/Acre)	
Erath Hood Johnson Palo Pinto Parker Somervell Tarrant Wise	February 1 – May 15	Green Sprangletop Sideoats Grama (El Reno) Bermudagrass Buffalograss (Texoka)	0.3 3.6 2.4 1.6	Green Sprangletop Sideoats Grama (El Reno) Bermudagrass Sand Dropseed	0.3 3.6 2.1 0.3
Collin Dallas Denton Ellis Kaufman Navarro Rockwell	February 1 – May 15	Green Sprangletop Sideoats Grama (El Reno) Buffalograss (Texoka) Bermudagrass	0.3 3.6 1.6 2.4	Green Sprangletop Buffalograss (Texoka) Bermudagrass Sand Dropseed	0.3 1.6 3.6 0.4
Hunt	February 1 – May 15	Green Sprangletop Bermudagrass Sideoats Grama (Haskell)	0.3 2.4 4.5	Green Sprangletop Bermudagrass	0.3 5.4

(Source: TxDOT Standard Specifications for Construction and Maintenance of Highways, Streets and Bridges, Item 164)

Vegetation for final stabilization of channels requires grasses that are tolerant of periodic inundation, such as Bermuda grass, Kentucky bluegrass or a grass-legume mixture.

## Additional Considerations

- Conditions for establishing vegetation vary significantly from site to site. Therefore, specifics of the vegetation design should be prepared based on the soil, slopes, drainage patterns, and the purpose of the vegetation at a each site.
- For construction activities that include landscaping in the development plans, the landscape architect should be consulted when specifying vegetation for temporary or final stabilization of disturbed areas.
- Vegetation is easier to establish if equipment and vehicle traffic is managed onsite to minimize soil compaction by traffic in the disturbed area that will be vegetated.
- Establishing a good vegetative cover is dependent on the season of the year. Projects that commence in the fall of the year may not be candidates for using vegetation as an erosion control.
- Where vegetation is used in swales and channels it may be necessary to use sod, rather than seeding, to establish an erosion resistant surface that accommodates rainfall runoff flows.
- Mulch should be used to enhance vegetative growth, in that mulch protects seeds from heat, prevents soil moisture loss, and provides erosion protection until the vegetation is established. Compost mulch has the additional benefit of providing some slow-release nutrients.
- Fertilizers have both beneficial and adverse effects. Fertilizers provide nutrients to the vegetation, but fertilizers are also a source of unwanted nutrients in streams and lakes. In this latter regard, they are a pollutant. The use of native vegetation rather than exotics reduces the need for fertilizers. Organic fertilizers, such as compost mulch, are generally preferred over chemical fertilizers. They provide a slow release of nutrients over a longer period of time and are less likely to cause environmental problems.
- Steep slopes represent a problem for establishing vegetation. Hydraulic mulches are useful for establishing vegetation on slopes. Refer to *Section 2.5 Mulching*.

### 2.9.4 Design Guidance and Specifications

Additional criteria for the application of vegetation in channels are in *Section 3.6.3 of the iSWM Criteria Manual* and design guidance is in *Section 3.2 of the Hydraulics Technical Manual*.

Specifications for construction of this item may be found in the Standard Specifications for Public Works Construction – North Central Texas Council of Governments, Item 202 Landscaping. Additional specifications for the following components of this item are in the Standard Specifications for Construction and Maintenance of Highways, Streets, and Bridges (TxDOT 2004):

- Topsoil, Item 160.
- Compost, Item 161.
- Sodding for Erosion Control, Item 162.
- Seeding for Erosion Control, Item 163.
- Fertilization, Item 164.
- Vegetative Watering 165.

### 2.9.5 Inspection and Maintenance Requirements

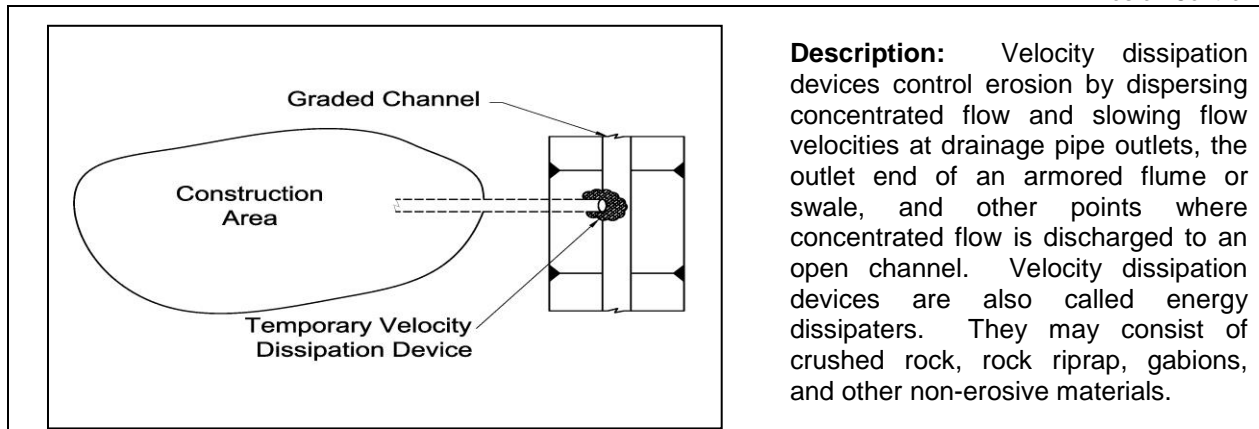
Protect newly seeded areas from excessive runoff and traffic until vegetation is established. Include a watering and fertilizing schedule in the iSWM Construction Plan facilitate the establishment of the vegetation. Vegetation for final stabilization must be maintained until the vegetative cover is 70 percent of the native background vegetative cover.

Vegetation should be inspected regularly (at least as often as required by the TPDES Construction General Permit) to ensure that the plant material is established properly and remains healthy. Bare spots shall be reseeded and/or protected from erosion by mulch or other measures. Accumulated sediment

deposited by runoff should be removed to prevent smothering of the vegetation. In addition, determine the source of excess sediment and implement appropriate measures to control the erosion.

## 2.10 Velocity Dissipation Devices

Erosion Control



**Description:** Velocity dissipation devices control erosion by dispersing concentrated flow and slowing flow velocities at drainage pipe outlets, the outlet end of an armored flume or swale, and other points where concentrated flow is discharged to an open channel. Velocity dissipation devices are also called energy dissipaters. They may consist of crushed rock, rock riprap, gabions, and other non-erosive materials.

### KEY CONSIDERATIONS

#### **DESIGN CRITERIA:**

- Use at discharge points into unlined and natural channels where the flow velocity exceeds 4 fps during construction
- Install permanent energy dissipaters in the first phase of construction when possible to eliminate the need for temporary devices
- Design based on discharge rate and velocity for the temporary control design storm (2-year, 24-hour)

#### **ADVANTAGES / BENEFITS:**

- Protects habitat in natural channels
- Protects new conveyance systems from damage due to erosion until permanent controls are installed

#### **DISADVANTAGES / LIMITATIONS:**

- Additional cost for temporary structures
- May be damaged by larger storm events

#### **MAINTENANCE REQUIREMENTS:**

- Inspect regularly
- Repair damaged devices and eroded areas
- Replace dislodged rock

### APPLICATIONS

**Perimeter Control**

**Slope Protection**

**Sediment Barrier**

**Channel Protection**

**Temporary Stabilization**

**Final Stabilization**

**Waste Management**

**Housekeeping Practices**

**Fe=N/A**

### IMPLEMENTATION CONSIDERATIONS

- Capital Costs
- Maintenance
- Training
- Suitability for Slopes > 5%

#### **Other Considerations:**

- *Coordination of temporary structures with the plans for permanent infrastructure*

### TARGETED POLLUTANTS

- Sediment
- Nutrients & Toxic Materials
- Oil & Grease
- Floatable Materials
- Other Construction Wastes

### 2.10.1 Primary Use

Velocity dissipation devices are used to disperse concentrated flow and slow velocities to a point where they will not cause erosion in a vegetated or natural drainage way. In process of slowing the flow, suspended sediments in runoff from disturbed areas may be removed from the runoff and settle in the dissipation device.

### 2.10.2 Applications

Velocity dissipation devices are used where velocities in concentrated flow may cause erosion of un-lined or natural channels during construction. These locations are typically where a constructed conveyance system (such as a storm drain pipe, concrete flume, or roadside drainage ditch) discharges flow to a channel that is larger in size or lower in elevation.

### 2.10.3 Design Criteria

#### General

- Temporary velocity dissipation devices should be installed at pipe outlets and similar discharge points during construction to maintain the downstream physical and biological characteristics and functions until channel protection and stabilization measures are installed. Other points that may require velocity dissipaters are locations where concrete flumes, drainage swales, roadside ditches, and other drainage structures discharge to an unlined or natural channel.
- The design and use of velocity dissipation devices during construction should be coordinated with the stormwater infrastructure design in the development plans. It is recommended that permanent devices be constructed early in the first phase of construction to provide velocity dissipation both during and post-construction, thus eliminating the need for temporary devices.
- The criteria in this section are specific to **temporary** velocity dissipation devices that are designed using the temporary control design storm (2-year, 24-hour). The design of permanent dissipation devices shall be in accordance with the municipality's drainage design criteria and are more stringent.
- Temporary dissipation devices must not block flow or cause flooding during larger storm events.
- Temporary dissipation devices shall be installed on all outlets where the design storm velocity exceeds 4 feet per second and the discharge is to an unlined or natural channel.

#### Rock Riprap

- Rock riprap is the most common material used for temporary velocity dissipation. The rock may be removed and re-used for other applications when permanent drainage structures, channel lining, or final stabilization measures are installed.
- Design calculations are required for the use of this control. The designer shall provide drainage computations, discharge velocity, stone size, and apron dimensions for each application.
- Rock may be natural stone or recycled concrete.
- The stone shall be well graded from 2 inch diameter through the median diameter ( $d_{50}$ ) and up to the maximum diameter ( $d_{MAX}$ ). The stone should create a homogeneous stone surface with no voids larger than 1½ inches in diameter.
- Stone shall be sized using the criteria for riprap aprons in [Section 4.0 of the Hydraulics Technical Manual](#) or using an alternative method accepted by the municipality reviewing the plans. The median stone size ( $d_{50}$ ) shall be a minimum of 6 inches for temporary velocity dissipation. The maximum stone size ( $d_{MAX}$ ) shall be 1.5 times  $d_{50}$ .
- Minimum depth of the riprap apron shall be 1.5 times  $d_{MAX}$ .



- Minimum length of the apron shall be 4.5 times the outlet pipe diameter or equivalent for other types of outlets.
- Minimum width of the apron shall be 4.0 times the outlet pipe diameter or equivalent for other types of outlets.
- Riprap should be placed on a lining of filter fabric to prevent soil movement into or through the riprap. The perimeter of the filter fabric must be keyed into the ground a minimum of 6 inches.
- Riprap apron should be aligned with flow direction.
- Riprap shall not be used where there is a difference in elevation between the outlet and the receiving channel.

### Other Devices

- Articulating concrete blocks, gabions, stilling basins or manufactured velocity dissipaters may be used for velocity dissipation if the designer provides calculations that document size and dimensions of the device for the design storm flow rate and velocities.
- Temporary baffled chutes, gabion drop structures, or other stabilized grade breaks shall be installed where an elevation difference exists at the outlet until permanent structures are installed.

#### 2.10.4 Design Guidance and Specifications

Criteria for the design of permanent design velocity dissipation devices are in [Section 3.6.3 of the iSWM Criteria Manual](#), and additional design guidance is in [Section 4.0 of the Hydraulics Technical Manual](#). Guidance is also available in the Federal Highway Administration Engineering Circular No. 14, [Hydraulic Design of Energy Dissipaters for Culverts and Channels](#).

Specifications for construction of this item may be found in the Standard Specifications for Public Works Construction – North Central Texas Council of Governments, Item 803, Slope and Channel Protection.

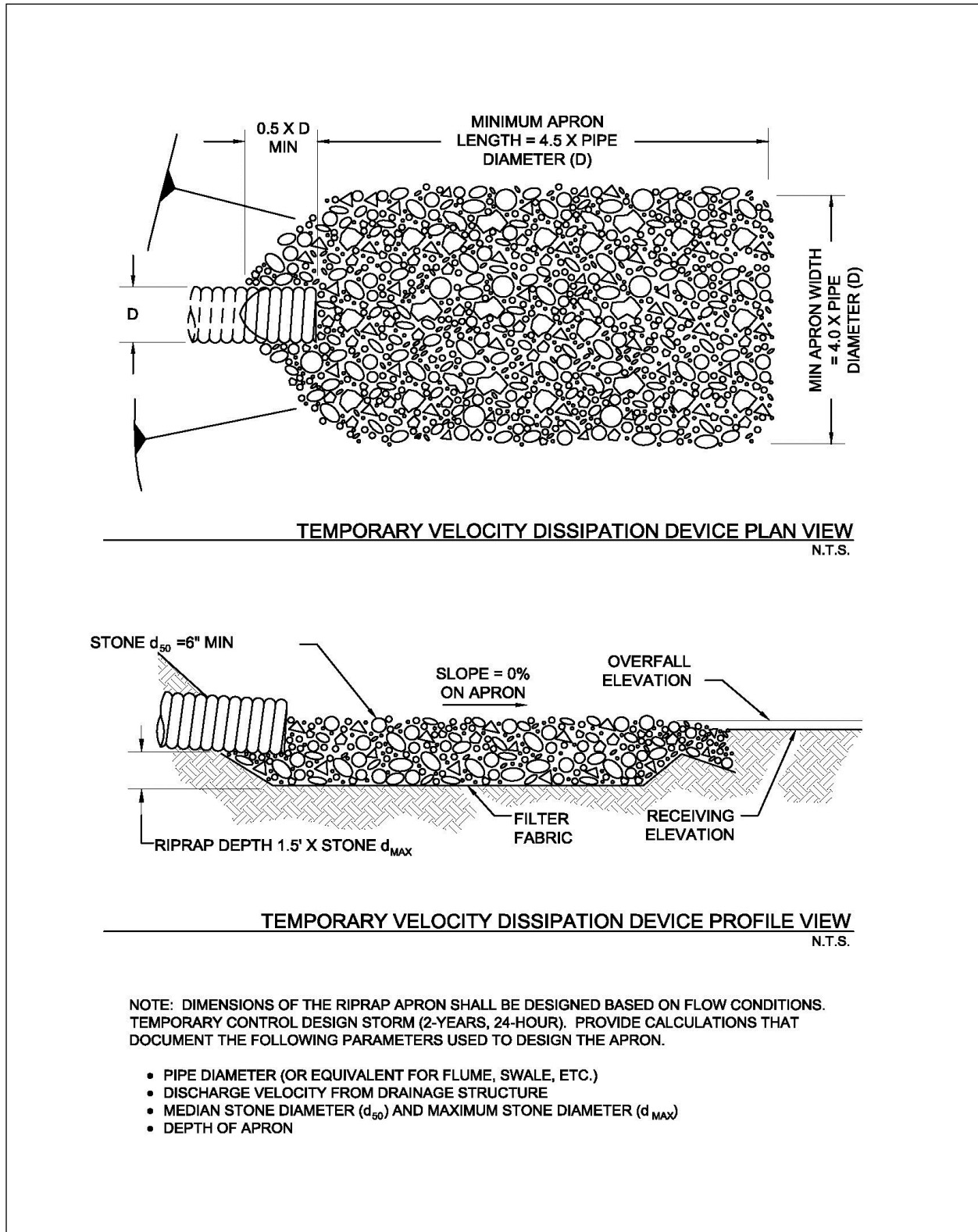
#### 2.10.5 Inspection and Maintenance Requirements

Discharge points shall be inspected regularly (at least as often as required by the TPDES Construction General Permit) for evidence of downstream erosion. Repair dislodges or missing rock riprap. The development of head-cuts, the deepening or widening of the channel, or low flow channels developing within the main channel are all evidence that additional velocity dissipation measures are required until permanent structures are installed.

#### 2.10.6 Example Schematics

The following schematics are only applicable to **temporary** installations of riprap for velocity dissipation. Permanent installations shall be in accordance with the municipality's design criteria.

The schematics are **not for construction**. They may serve as a starting point for creating a construction detail, but they must be site adapted by the designer. In addition, dimensions and notes appropriate for the application must be added by the designer.



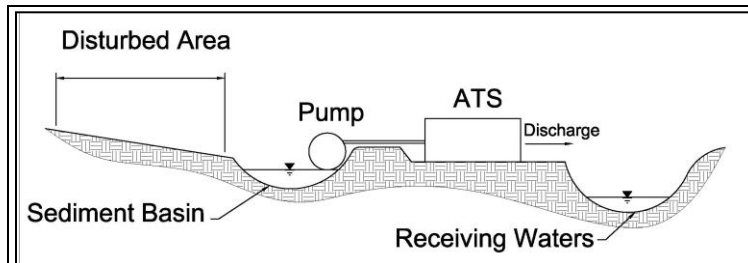
**Figure 2.13 Schematics of Velocity Dissipation Device**

(Source: Modified from Oklahoma City Public Works Engineering Division Detail ERO-A17)

## 3.0 Sediment Controls

### 3.1 Active Treatment System (ATS)

#### Sediment Control



**Description:** An Active Treatment System (ATS) is a small, onsite, water treatment plant used to produce discharge water quality that is better than can be achieved by traditional sediment controls. Common ATS methods are filtration and chemical-aided coagulation/flocculation.

#### KEY CONSIDERATIONS

##### DESIGN CRITERIA:

- ATS designed based on site conditions, stormwater characteristics, and required discharge quality
- ATS shall be designed in coordination with the system provider and operator

##### ADVANTAGES / BENEFITS:

- Provides consistent, high quality, stormwater discharges

##### DISADVANTAGES / LIMITATIONS:

- Most expensive treatment method
- Retention structures required to capture the design storm for treatment
- Filtration requires pre-treatment with a sediment trap or basin
- Highly dependent on operator knowledge and skill level

##### MAINTENANCE REQUIREMENTS:

- Daily monitoring and maintenance while in operation, including influent characteristics and chemical dosage
- Backwash filters and dispose of waste from backwashing
- Monitor discharge for residual chemicals
- Repair erosion or other damage on stormwater retention structures that precede the ATS

#### TARGETED POLLUTANTS

- Sediment
- Nutrients & Toxic Materials
- Oil & Grease
- Floatable Materials
- Other Construction Wastes

#### APPLICATIONS

Perimeter Control

Slope Protection

Sediment Barrier

Channel Protection

Temporary Stabilization

Final Stabilization

Waste Management

Housekeeping Practices

**Fe=0.99**

#### IMPLEMENTATION CONSIDERATIONS

- Capital Costs
- Maintenance
- Training
- Suitability for Slopes > 5%

##### Other Considerations:

- *Operator training*
- *Site access to operate the ATS during wet conditions*
- *Worker safety and spill response procedures*

### 3.1.1 Primary Use

Active treatment systems (ATS) are used when traditional sediment controls cannot achieve the necessary level of sediment removal for discharges from a construction site. They are primarily used to remove fine silt and clay soil particles, for which traditional sediment controls are the least effective. These fine particles are small enough to pass through the pores or void spaces of sediment barriers. They are also not removed by sediment basins, because their settling velocities require a detention time of days or weeks, not hours.

### 3.1.2 Applications

Active treatment systems are applicable on sites that have a large percentage of fine silt and clay soils. The systems are most useful where special aquatic sites or sensitive receiving waters result in specific limits on discharges or regulations require a higher level of treatment. An ATS may be used when a turbidity effluent limit is established for a construction activity or where the activity discharges to:

- Wetlands regulated under Section 404 of the Clean Water Act;
- Spring-fed receiving waters;
- Receiving water with a Total Maximum Daily Load;
- Receiving water bodies with a Water Quality Standard that could be exceeded by the discharge; or
- Receiving water utilized by a species protected under the Federal Endangered Species Act or the State of Texas Threatened and Endangered Species Regulations.

### 3.1.3 Design Criteria

Active treatment systems are a specialized application that requires skill in designing, operating, and maintaining the systems. When the designer has determined that an ATS is needed for a project, the designer should select a supplier of ATSS and work with their technical experts. The criteria contained in this section are general guidelines. It is essential that the designer of controls for a construction activity work with an ATS supplier and operator to develop an effective system based on site conditions and anticipated characteristics of the stormwater runoff.

#### General

- A source of electricity is required for an ATS. Diesel generators are required until the electrical distribution system is extended to the site. In some cases, it may be advisable to maintain the generators onsite for the duration of the project in case of power outages.
- An ATS requires a sediment basin, tank, or other structure to capture the temporary control design storm (2-year, 24-hour) and retain it to be pumped to the ATS. The retention structure should be designed to pass larger storm events without damage to the structure.
- An ATS can be either a batch flow or flow-through (continuous flow) design.
- ATS designs are specific to each site, the stormwater runoff characteristics, and the required discharge water quality. The designer should consult with suppliers and operators of ATSS and consider the following when designing the ATS:
  - Available stormwater detention space for the storm event being treated and for another event that could occur during treatment.
  - Turbidity, pH, and suspended solids concentrations of the stormwater to be treated.
  - Size of soil particles to be removed.
  - Required discharge concentrations.
  - Flow rate through the ATS.

- Available space.
- Cost.
- Electrocoagulation is available as an ATS for sediment removal; however, it is not recommended for construction sites.
- The design should include requirements for operator training and/or required skill and experience for the lead operator. Unlike other sediment control devices, improper operation can result in a discharge that is more damaging to the receiving water than the construction activity. The recommended minimum skill level is 5 years experience operating stormwater ATSs or a combination of training and experience equivalent to a Class C Surface Water Operators license in the State of Texas.
- The ATS operator selected for the project shall have written plans for the following:
  - Operation and maintenance manual for all equipment in the ATS.
  - Monitoring, sampling and reporting, including Quality Assurance/Quality Control (QA/QC).
  - Worker health and safety.
  - Spill prevention and response.
- The ATS shall be equipped with instrumentation that automatically measures and records the following:
  - Influent and effluent turbidity.
  - Influent and effluent pH.
  - Influent and effluent flow rate.
- The ATS should be designed with a recirculation mode or a safe shut down mode that will be automatically activated upon system upset, power failure, or other catastrophic event.
- A velocity dissipation device is required at the ATS discharge point.

## Filtration

- Filtration is accomplished by pumping water through vessels filled with granular filter media. The media may be sand, gravel, anthracite or a combination. Single media, sand filters are most common in construction applications.
- Bag or cartridge filters may be used after the media filter to provide the highest level of sediment removal. They are typically only needed when extremely low turbidity values (<10 NTU) are required for discharges to clear, cool-water streams, such as spring-feed creeks flowing over a limestone channel bed.
- For temporary installations at construction sites, filtration units are frequently hauled to the site and operated on flat bed trailers.
- The designer shall specify the filter media to be used based on the particle size to be removed and desired reduction in turbidity and suspended solids concentrations.
- Filtration can be effective in removing other pollutants from construction sites, such as sheen on stormwater surfaces; however, the filter media must then be classified and handled as the appropriate type of waste.
- Filtration may be used as an ATS by itself on sites where the suspended soils are primarily coarser silts and sands and a higher quality discharge is required than can be achieved by traditional sediment controls.
- Filtration systems are most commonly used after chemical-aided flocculation to remove flocs that do not settle within the detention time available while maintaining the design flow rate.

- When used without chemical-aided flocculation, stormwater requires pre-treatment with a sediment trap or basin before being pumped to the filter. Pre-treatment extends the operating life of the filter and decreases maintenance requirements.
- Filters shall be equipped with gauges to measure differential pressure across the filter to monitor filter loading.
- Filtration designs shall contain a means for backwashing the filters and collection and disposal of the backwash water.

### **Chemical-Aided Flocculation**

- Chemicals are added as coagulation agents in an ATS. The coagulants destabilize the charged soil particles. As a result, the particles form flocs that can be settled or filtered from the stormwater.
- The ATS typically consists of the following, each of which requires its own design parameters:
  - Retention basin or other structure to capture the design storm.
  - Water pump to convey stormwater from the retention structure to the settling tank.
  - Chemical injection and metering pump.
  - Settling tank or chamber.
  - Filters (optional).
- Commonly used chemicals for stormwater treatment are chitosan, polyacrylamide (PAM), aluminum sulfate (alum), and polyaluminum chloride.
- Chemicals must be applied in proper doses and for the proper contact times to avoid potential toxicity in the ATS effluent. The effluent should be monitored for both turbidity and residual concentration of the treatment chemical.
- Where feasible, chemical injection should occur on the intake side of the stormwater pump to provide for maximum mixing.
- Chemical dosing should be designed based on flow rate, pH, and suspended solids concentration. Adjustments to dosage are common as the stormwater characteristics vary for different storm events and changing conditions on the construction site.
- Jar tests should be used to determine the chemical dosage. Jar tests should be conducted in accordance with ASTM D2035 Standard Practice for Coagulation-Flocculation Jar Test of Water. Tests shall be performed 15 minutes after start-up and every 8 hours of operation.
- The settling tank or chamber should be designed to prevent the accidental discharge of settled floc during floc pumping and related cleaning operations. Include specifications for disposal of settled floc.
- When chitosan is used, the discharge from the ATS should be tested for residual concentration of the chemical using commercially available residual field tests. Tests should be performed 15 minutes after start-up, every 8 hours of operation, and 15 minutes after each change in dosage. Return period of the test results depends on the sensitivity of the receiving water, but in no case should be longer than 24 hours. Return period may be as short as one hour if the receiving water has a species that is threatened, endangered, or of concern.
- The residual concentration of chitosan should be limited to 10 percent or less of the following for the aquatic species most sensitive to the chemical being used:
  - Geometric mean of the No Observed Effect Concentration (NOEC).
  - Acute toxicity concentration.
  - Chronic toxicity concentration.

- For PAM and other coagulation agents without a residual field test, a daily bioassay shall be performed on an effluent sample. The methods used for acute toxicity testing shall be those outlined for a 96-hour acute test in Methods for Measuring the Acute Toxicity of Effluents and Receiving Water to Freshwater and Marine Organisms (USEPA-841-R-02-012) for Fathead minnow, *Pimephales promelas*.
- PAM has a documented record of low toxicity. For all other chemical coagulants without a residual field test, batch operation of the ATS is encouraged to delay discharge of the treated stormwater until results of the toxicity tests are available.
- Toxicity testing should be done by an independent, third-party laboratory that is accredited in Texas according to the standards of the National Environmental Laboratory Accreditation Conference (NELAC).

### 3.1.4 Design Guidance and Specifications

No specification for construction of this item is currently available in the Standard Specifications for Public Works Construction – North Central Texas Council of Governments.

### 3.1.5 Inspection and Maintenance Requirements

Active treatment systems must be maintained and monitored by trained, onsite personnel that observe the system at all times while it is in operation. Inspection and maintenance should be according to the system's operations and maintenance manual.

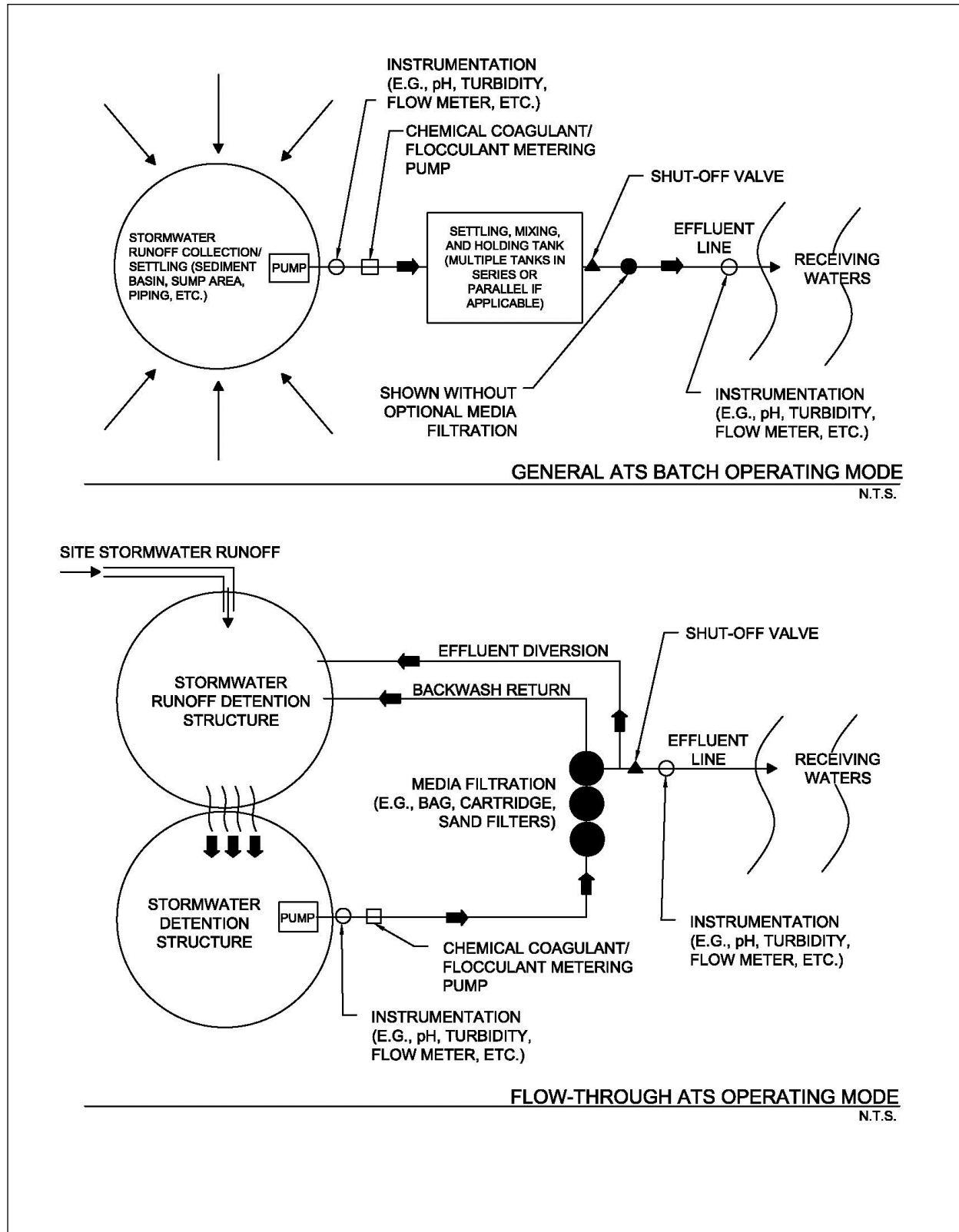
The overall system should be inspected regularly (at least as often as required by the TPDES Construction General Permit) to ensure stormwater is not bypassing the ATS. The basin or other structure used to collect and pre-treat stormwater should be inspected for damage and repaired as needed.

During operation of chemical-aided flocculation, the chemical dosage should be monitored and changed according to characteristic of the stormwater inflow. The discharge from the ATS should be sampled and analyzed regularly to verify that chemical residuals are acceptable levels.

### 3.1.6 Example Schematics

The following schematics are example applications of the construction control. They are intended to assist in understanding the control's design and function.

The schematics are **not for construction**. They may serve as a starting point for creating a construction detail, but they must be site adapted by the designer. In addition, dimensions and notes appropriate for the application must be added by the designer.



**Figure 3.1 Schematics of Active Treatment System**

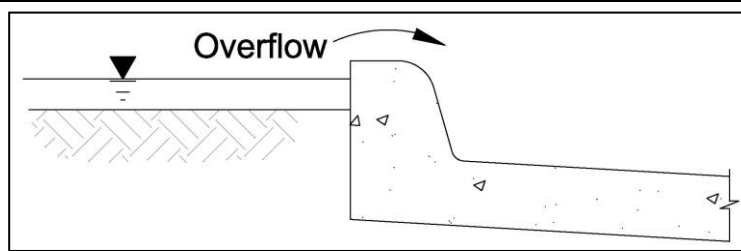
(Source: EPA Development Document for Final Effluent Guidelines and Standards for the Construction & Development Category)



## 3.2 Depressed Grade (Curb Cut-Back) Sediment Trap

(Source: Modified from City of Plano BMP SP-12)

Sediment Control



**Description:** A depressed grade sediment trap is a sediment barrier created by grading or leaving the grade of an area at the back of curb or edge of pavement depressed to detain the surface flow until overflows onto the pavement.

### KEY CONSIDERATIONS

#### **DESIGN CRITERIA:**

- Minimum 4 feet width and 1.5 inch depth
- Maximum 2 percent longitudinal slope and 3 percent transverse slope
- Erosion control blankets required at low point (sag) curb inlets

#### **ADVANTAGES / BENEFITS:**

- Inexpensive sediment trap for very small areas
- Alternative to inlet protection for projects within rights-of-way
- May be used on individual residential lots in certain situations

#### **DISADVANTAGES / LIMITATIONS:**

- May be disturbed and altered by construction equipment driving through it
- Limited application to very small areas along rights-of-way and residential lots

#### **MAINTENANCE REQUIREMENTS:**

- Inspect regularly
- Use a shovel or blade to remove sediment
- Re-grade as necessary
- Inspect erosion control blankets and repair as needed

### TARGETED POLLUTANTS

- Sediment
- Nutrients & Toxic Materials
- Oil & Grease
- Floatable Materials
- Other Construction Wastes

### APPLICATIONS

Perimeter Control

Slope Protection

Sediment Barrier

Channel Protection

Temporary Stabilization

Final Stabilization

Waste Management

Housekeeping Practices

**Fe=0.50-0.75**

*(Depends on soil type)*

### IMPLEMENTATION CONSIDERATIONS

- Capital Costs
- Maintenance
- Training
- Suitability for Slopes > 5%

#### **Other Considerations:**

- None

### 3.2.1 Primary Use

Depressed grade sediment traps are used to intercept and trap flows from very small drainage areas (i.e. parkways, medians, and pavements).

### 3.2.2 Applications

Depressed grade sediment traps are used at construction sites within rights-of-way to control small drainage areas. It can be used at the back of curb or edge of pavement where the drainage area is limited to the parkway or median. It can also be used where sections of pavement are removed and replaced for pavement repair or underground utility installation.

### 3.2.3 Design Criteria

- The width of the excavated area when installed back of curb shall be a minimum of 4 feet.
- The longitudinal slope along the back of curb depression cannot exceed 2 percent and the transverse slope toward the back of curb cannot exceed 3 percent. Steeper slopes require additional sediment controls.
- The maximum width of the right-of-way draining into the sediment trap shall be 11.5 feet. No other drainage area may contribute runoff to the sediment trap.
- The depressed grade sediment trap may be used back of curb for sediment control on single residential lots if no other drainage area contributes runoff to the depressed area. The designer shall calculate the minimum width of the depressed area, based on a 1.5 inch depth, the length of the curb at the front of the lot, and the volume of runoff from the lot for the temporary control design storm (2-year, 24-hour).
- Erosion control blankets (ECBs) are required at low or sag points along the curb where flow may become more concentrated. Criteria for ECBs are in [Section 2.3 Erosion Control Blankets](#).
- The excavation of the cut may be offset a maximum distance of 5 feet from the curb to avoid utility boxes.
- When a curb cut for a driveway is encountered and no driveway has been constructed, securely install a plank of wood (2x4, 4x4) across the cur cut in order to continue the curb.

### 3.2.4 Design Guidance and Specifications

No specification for depressed grade sediment trap is currently available in the Standard Specifications for Public Works Construction – North Central Texas Council of Governments.

### 3.2.5 Inspection and Maintenance Requirements

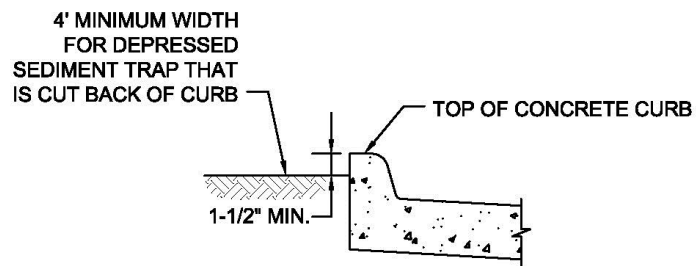
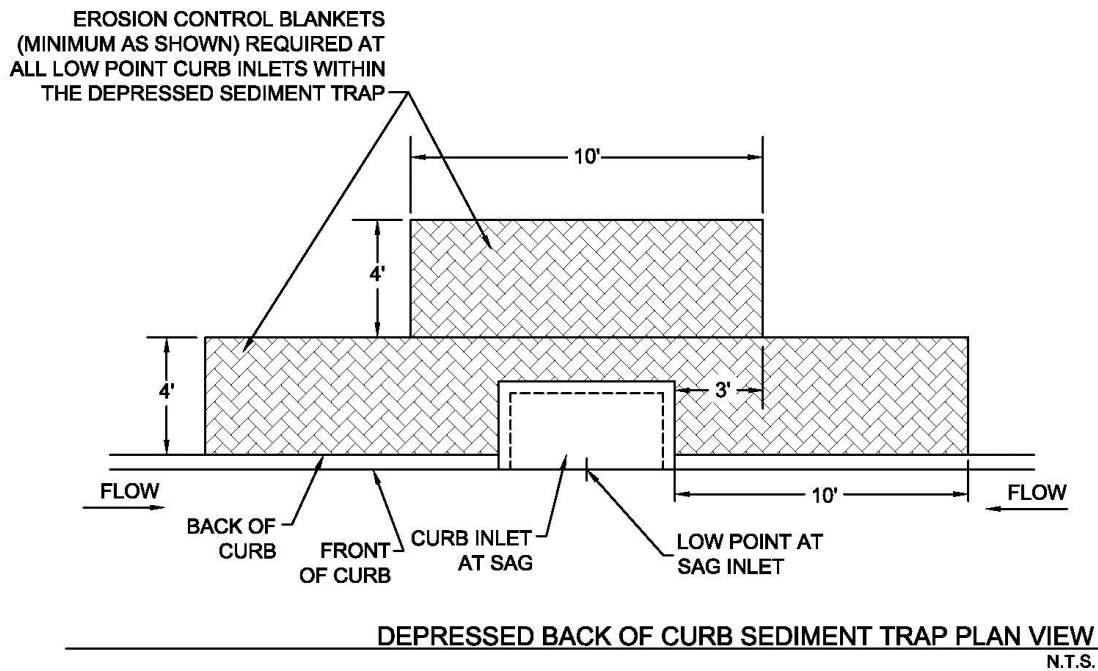
Depressed grade sediment traps should be inspected regularly (at least as often as required by TPDES Construction General Permit). Inspect the depression area periodically to ensure that the necessary storage volume is available. Use a shovel or blade to remove sediment from the area back of curb as needed. Re-grade the depression if it's disturbed by construction traffic.

The low points where this method is used should also be monitored during rain events to ensure the erosion control blankets are adequate to prevent sediment from flowing onto the pavement. Additional controls shall be added as needed.

### 3.2.6 Example Schematics

The following schematics are example applications of the construction control. They are intended to assist in understanding the control's design and function.

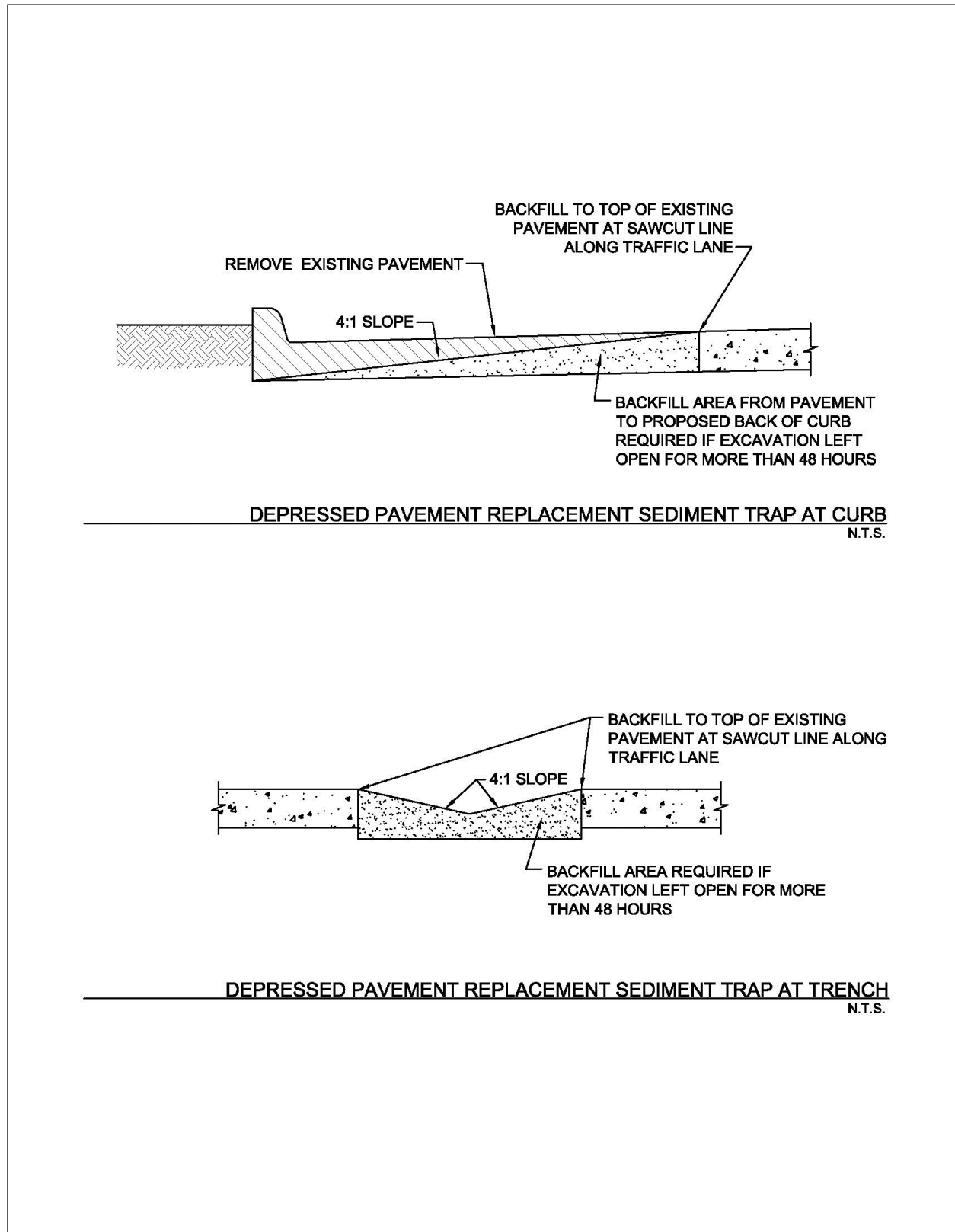
The schematics are **not for construction**. They may serve as a starting point for creating a construction detail, but they must be site adapted by the designer. In addition, dimensions and notes appropriate for the application must be added by the designer.



- NOTES: 1. THE DEPRESSED SEDIMENT TRAP MAY BE OFFSET A MAXIMUM DISTANCE OF 5 FEET FROM THE CURB IF NECESSARY TO AVOID UTILITY BOXES.  
2. WHEN A CURB CUT FOR A FUTURE DRIVEWAY IS ENCOUNTERED, INSTALL 2" X 4" BOARDS ACROSS THE CURB TO FORM A TEMPORARY "CURB" FOR THE SEDIMENT TRAP.

**Figure 3.2 Schematics of Depressed Grade (Curb Cut-Back) Sediment Trap**

(Source: City of Plano BMP SP-12)

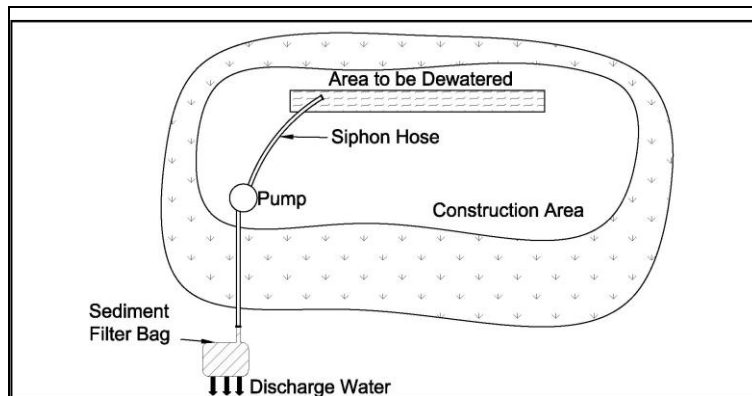


**Figure 3.3 Schematics of Depressed Pavement Replacement Sediment Trap**

(Source: City of Plano BMP SP-12)

### 3.3 Dewatering Controls

**Sediment Control**



**Description:** Dewatering controls consist of methods and devices to remove suspended soil in water that is pumped or otherwise discharged from foundations, trenches, excavations, and other low areas. The controls may be the sediment controls already onsite (e.g. silt fence, organic filters tubes) or dedicated dewatering devices such as sediment tanks and sediment filter bags.

**KEY CONSIDERATIONS**

**DESIGN CRITERIA:**

- Discharge of pumped water is prohibited unless controlled for the removal of suspended soil
- Select controls based on dewatering flow rate and duration and available space
- Dewatering discharge points must be protected for high velocities

**ADVANTAGES / BENEFITS:**

- Removes suspended soil and some pollutants from pumped water
- Works well with passive treatment systems for removal of clay soil particles
- Water may be applied to other onsite uses

**DISADVANTAGES / LIMITATIONS:**

- Requires frequent maintenance

**MAINTENANCE REQUIREMENTS:**

- Inspect regularly
- Monitor for erosion, control failure and unauthorized discharges frequently while pumping
- Clean and replace controls as they are filled with sediment

**TARGETED POLLUTANTS**

- Sediment
- Nutrients & Toxic Materials
- Oil & Grease
- Floatable Materials
- Other Construction Wastes

**APPLICATIONS**

- Perimeter Control
- Slope Protection
- Sediment Barrier**
- Channel Protection
- Temporary Stabilization
- Final Stabilization
- Waste Management
- Housekeeping Practices

**Fe=0.50-0.75**

*(Depends on soil type)*

**IMPLEMENTATION CONSIDERATIONS**

- Capital Costs
- Maintenance
- Training
- Suitability for Slopes > 5%

**Other Considerations:**

- None

### 3.3.1 Primary Use

Dewatering controls are used to remove suspended soil in water that is pumped or otherwise discharged from foundations, trenches, excavations, and other low areas. Some dewatering controls, such as the temporary sediment tank, may also be useful in removing other pollutants.

### 3.3.2 Applications

Dewatering controls are applicable whenever water must be pumped from a low area on a construction site before construction can continue in that area. Pumping of foundations, excavated trenches, and utility vaults are common on development projects.

Dewatering controls may also apply when a temporary cofferdam has been constructed to dewater a normally wet area for construction, such as road crossings of creeks and bank stabilization projects. Water pumped from these areas must flow through a control before it is discharged back to the water body.

### 3.3.3 Design Criteria

#### General

- Construction plan notes shall prohibit the discharge of water from dewatering activities into public streets, flumes, storm drains, creeks or other drainage ways unless controlled to remove suspended soil or other pollutants.
- The designer shall determine whether dewatering will be a batch operation after storm events or a continuous operation due to high groundwater and specify controls accordingly. Controls for continuous dewatering need to provide effective removal of sediment over long periods. Controls that clog easily are not appropriate for controlling long-term dewatering operations.
- Pumped water that has sheen or other evidence of pollutants shall be collected and sampled before it is discharged. State or local discharge permit requirements may exist for the pollutant(s) suspected of being in the water.
- Regulations or effluent criteria that apply to stormwater discharges from a construction activity typically also apply to water discharged from dewatering activities.
- The dewatering controls in this section are most effective with sands and coarse silts. Dewatering controls may be combined with a passive treatment system to provide higher sediment removal rates for fine silt and clay soil particles. Liquid polymers injected at the pump or solid and gel forms installed at the discharge generally work well to promote floc growth and settling of clay soil. Design criteria are contained in [Section 3.7 Passive Treatment System](#).

#### Conventional Controls

- Discharges from dewatering are typically concentrated and have relatively high flow rates and velocities. If conventional controls are used, velocity dissipaters and/or flow spreaders or levelers are required before the control to prevent the discharge from causing erosion and damaging the control.
- The best control for pumped water is to discharge it to a vegetated area.
- Pumped water should be sprayed through a nozzle on the end of a discharge hose or directed to a device that dissipates velocity and disperses flow before the water enters the vegetated area.
- The vegetated area must be large enough to detain the volume being dewatered. The size of area needed is dependent on type of vegetation (interception storage and water uptake capacity) and soil type (infiltration rate) and condition (wet or dry). Vegetation may not be a feasible option if dewatering is due to a large or prolonged storm event and the vegetated area is saturated or if the soil has high clay content.

- If a vegetated area is not available or feasible, the discharge from dewatering may be directed to a conventional sediment barrier, such silt fence, organic filter tubes, sediment basin, or stone outlet sediment trap.
- Opportunities for using the water onsite should be considered, particularly where groundwater intrusion results in frequent or continuous dewatering. The water may be collected in a temporary, onsite storage container or holding pit and used to water vegetation for stabilization, applied for dust control, or used for pavement subgrade preparation. If any of these water needs are present at the time of dewatering, the water may be applied directly to this use without sediment controls, since no discharge occurs.

## **Sediment Filter Bag**

- Sediment filter bags are specifically designed to control pumped water and connect directly to the pump discharge line.
- Show location of the filter bag on the drawings. The bag installed where its discharge will flow away from the disturbed area and onto vegetation or into a swale or drainage ditch with erosion and sediment controls.
- Bags should be placed on a level, stable surface that is prepared with mulch, straw, small aggregate, or other material as recommended by the manufacturer. In some cases, the bag may be placed directly on vegetation or well graded soil. The key is to have a surface without rocks or other protrusions that could puncture the bag.
- The bag should be made of a non-woven, needle-punched, geotextile that meets the following minimum criteria:
  - 205 lbs minimum tensile strength using ASTM D4632 Test Method for Grab Breaking Load and Elongation of Geotextiles.
  - 130 lbs minimum puncture strength using ASTM D4833 Test Method for Index Puncture Resistance of Geotextiles, Geomembranes, and Related Products.
  - 400 psi minimum Mullen burst strength using ASTM D3786 Standard Test Method for Hydraulic Bursting Strength of Textile Fabrics-Diaphragm Bursting Strength Tester Method.
  - Minimum 70 percent at 500 hours ultraviolet resistance using ASTM D4355 Standard Test Method for Deterioration of Geotextiles by Exposure to Light, Moisture, and Heat in a Xenon Arc Type Apparatus.
  - 85 to 110 gpm/ft<sup>2</sup> water flow rate using ASTM D4491 Standard Test Methods for Water Permeability of Geotextiles by Permittivity.
- Apparent opening size using ASTM D4751 Test Method for Determining Apparent Opening Size of a Geotextile should be specified based on the type of soil that will be in the discharge. A size that is too large will not trap the sediment; however, a size that is too small will create an unnecessary head for the dewatering pump to work against.
- The smallest apparent opening size currently available is 70 microns. This size will not capture fine silt and clay particles. A passive treatment system will be necessary with the bag to capture these soils.
- Bags are available in sizes ranging from 6 feet x 6 feet to 15 feet x 25 feet. The size of the bag should be specified based on availability of space, flow rates, and duration of use. If space is available, larger bags will last longer between replacements and may have a lower price per square foot. However, larger bags are heavier when sediment-laden. Equipment must be available to lift and remove the bag from the site for disposal.
- Bags are not reusable. Make sure they are installed at a location where equipment has access to the bags for lifting and removal without causing erosion or damaging other erosion and sediment controls.



## Temporary Sediment Tank

- A temporary sediment tank is a compartmented container through which sediment-laden water is pumped to trap and retain sediment before discharging the water to drainage ways, adjoining properties, and rights-of-way below the sediment tank site.
- A temporary sediment tank is typically used at construction sites in urban areas where conventional methods of sediment removal are not practical. It is also used on sites where excavations are deep and space is limited, such as urban construction, where direct discharge of sediment-laden water to streams and storm drainage systems should be avoided.
- The location of temporary sediment tanks should facilitate easy cleanout and disposal of the trapped sediment to minimize interference with construction activities and pedestrian traffic. The tank size should be determined according to the storage volume of the sediment tank, with 1 cubic foot of storage for each gallon per minute of pump discharge capacity.
- A temporary sediment tank can be used as either a sedimentation or filtration device. If an oil sheen is present in the runoff, an underflow baffle may be used in the tank to remove it. However, local and state discharge regulations and permits may apply and should be checked before discharging.
- For use as a small scale sedimentation basin, de-watering discharge is directed into the temporary sediment tank to a level below the tank midpoint and held for a minimum of 2 hours to allow settlement of a majority of the suspended particles. This detention time is insufficient for removal of fine silt and clay soil particles. Passive treatment systems should be combined with the tank if these soil particles will be present.
- The tank should be designed for a controlled release when the contents of the tank reach a level higher than the midpoint.
- As a filtration device, a temporary sediment tank is used for collecting de-watering discharge and passing it through a filtered opening at the outlet of the tank to reduce suspended sediment volume. The filter opening in the temporary sediment tank should have an Apparent Opening Size (AOS) (see [Section 3.10 Silt Fence](#)) of 70 or smaller.
- The trapped sediment and stormwater must be disposed of properly.

### 3.3.4 Design Guidance and Specifications

No specification for dewatering controls is currently available in the Standard Specifications for Public Works Construction – North Central Texas Council of Governments.

### 3.3.5 Inspection and Maintenance Requirements

Dewatering controls should be inspected regularly (at least as often as required by the TPDES Construction Permit). Dewatering discharge points should be checked for erosion. Eroded areas should be repaired, and erosion controls should be installed to prevent future erosion.

Dewatering pumps and sediment controls should be monitored frequently, at least hourly, while pumps are in operation to prevent unauthorized discharges and to catch erosion problems or control failure.

Conventional sediment controls should be inspected at least weekly when used for continuous dewatering, because they will become overcome with sediment more quickly than when used to control runoff from storm events. The controls shall be maintained according to the criteria in their respective sections. They should be replaced when they no longer provide the necessary level of sediment removal.

Sediment filter bags should be checked to determine if they need replacing. The bags cannot be cleaned or reused. They should be used until they reach the manufacturer's recommended capacity. The entire bag with sediment can be disposed of as solid waste. If a controlled location onsite or a spoil site is available, the bag can be cut open and the sediment spread on the ground. Only the bag is waste in this case.

Sediment tanks should be cleaned when they become  $\frac{1}{3}$  full of sediment. To facilitate maintenance, the tanks need to be located with easy access for regular pump out. The rate at which a tank is pumped depends on site-specific considerations such as rainfall and sediment loads to the system. Regular inspections will help determine pump out frequency and prevent overloading and failure of the system.

### 3.3.6 *Example Schematics*

The following schematics are example applications of the construction control. They are intended to assist in understanding the control's design and function.

The schematics are **not for construction**. They may serve as a starting point for creating a construction detail, but they must be site adapted by the designer. In addition, dimensions and notes appropriate for the application must be added by the designer.

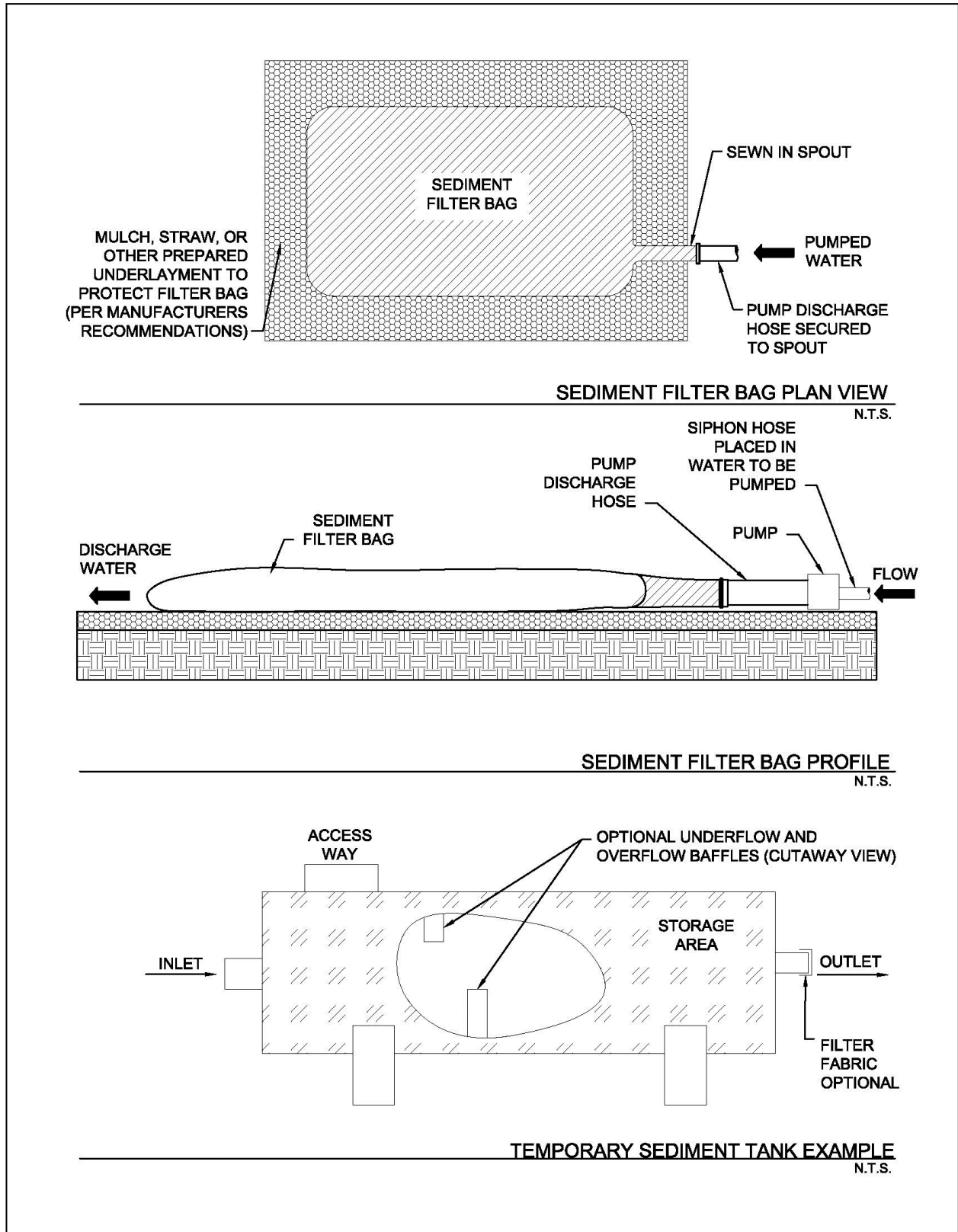
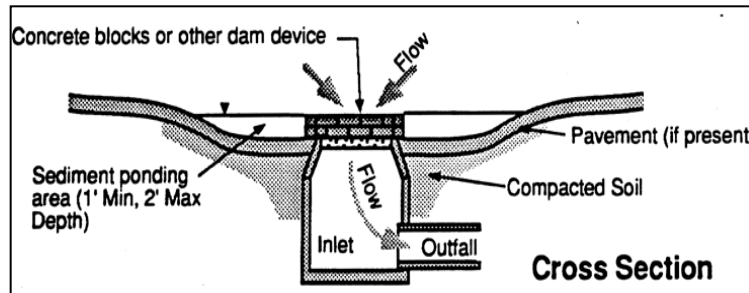


Figure 3.4 Schematics of Dewatering Controls

### 3.4 Inlet Protection

**Sediment Control**



**Description:** Inlet protection consists of a variety of methods to intercept sediment at low point inlets through the use of depressed grading, filter stone, filter fabric, inlet inserts, organic filter tubes and other materials. The protection devices are placed around or across the inlet openings to provide localized detention or filtration of sediment and floatable materials in stormwater. Protection devices may be assembled onsite or purchased as manufactured assemblies.

**KEY CONSIDERATIONS**

**DESIGN CRITERIA:**

- Evaluate drainage patterns to ensure inlet protection will not cause flooding of roadway, property or structures
- Never block entire inlet opening
- Size according to drainage area and flow rates
- Include flow bypass for clogged controls and large storm events

**ADVANTAGES / BENEFITS:**

- May be the only feasible sediment control when all construction is located within rights-of-way

**DISADVANTAGES / LIMITATIONS:**

- Limited effectiveness and reliability
- High maintenance requirements
- Has potential to flood roadways or adjacent properties

**MAINTENANCE REQUIREMENTS:**

- Inspect regularly
- Check for and remove blockage of inlet after every storm event
- Remove sediment before it reaches half the design height or volume of the inlet protection, more frequently for curb inlets
- Repair or replace damaged materials
- Clean or replace filter stone and organic filter tubes is when clogged with sediment

**TARGETED POLLUTANTS**

- Sediment
- Nutrients & Toxic Materials
- Oil & Grease
- Floatable Materials
- Other Construction Wastes

**APPLICATIONS**

**Perimeter Control**

**Slope Protection**

**Sediment Barrier**

**Channel Protection**

**Temporary Stabilization**

**Final Stabilization**

**Waste Management**

**Housekeeping Practices**

**Fe=0.35-0.65**

*(Depends on soil type)*

**IMPLEMENTATION CONSIDERATIONS**

- Capital Costs
- Maintenance
- Training
- Suitability for Slopes > 5%

**Other Considerations:**

- Traffic hazards
- Passage of larger storm events without causing flooding
- Flow diversion to other inlets or drainage points

### 3.4.1 Primary Use

Inlet protection is typically used as a secondary sediment barrier, due to its limited effectiveness and numerous disadvantages. It is used to reduce sediment in storm sewer systems by serving as a back-up system for areas that have newly applied erosion controls or for other sediment controls that cannot achieve adequate sediment removal by themselves.

Inlet protection may be used as a primary sediment control only when all other primary controls are infeasible because of site configuration or the type of construction activity.

### 3.4.2 Applications

Inlet protection is best applied at low point (sump) inlets where stormwater runoff will pond behind the protection measure, and then either filter through the protection measure or flow over a weir created by it. Most inlet protection measures depend on ponding to be effective. These types of inlet protection are not applicable to on-grade curb inlets, where the inlet protection will cause stormwater runoff to bypass the inlet and overload downstream inlets. Only inlet protection measures that allow for use of the inlet opening (e.g. inlet inserts) are applicable as inlet protection for on-grade inlets.

Inlet protection is normally used in new developments with new inlets and roads that are not in public use. It has limited applications in developed areas due to the potential for flooding, traffic safety, pedestrian safety, and maintenance problems. Potential applications in developed areas are on parking lot inlets where water can pond without causing damage and during major repairs to existing roadways where no other controls are viable.

The application of inlet protection is highly variable due to the wide variety of inlet configurations (existing and new) and site conditions. The schematics in Section 6 show example applications; however, applications in most cases must be site adapted. Different methods and materials may be used. It is the responsibility of the designer to ensure that the methods and materials applied for inlet protection are appropriate to the site and flow conditions following the design criteria in Section 3.

### 3.4.3 Design Criteria

#### General

- Drainage patterns shall be evaluated to ensure inlet protection will not divert flow or flood the roadway or adjacent properties and structures.
- Inlet protection measures or devices that completely block the inlet are prohibited. They must also include a bypass capability in case the protection measures are clogged.
- Inlet protection must be designed to pass the conveyance storm (25-year, 24-hour) without creating a road hazard or damaging adjacent property. This may be accomplished by any of the following measures:
  - An overflow weir on the protection measure.
  - An existing positive overflow swale on the inlet.
  - Sufficient storage volume around the inlet to hold the ponded water until it can all filter into the inlet.
  - Other engineered method.
- Positive overflow drainage is critical in the design of inlet protection. If overflow is not provided for at the inlet, temporary means shall be provided to route excess flows through established swales, streets, or other watercourses to minimize damage due to flooding.
- Filter fabric and wire mesh used for inlet protection shall meet the material requirements specified in [Section 3.10 Silt Fence](#).

- Block and gravel (crushed stone or recycled concrete) protection is used when flows exceed 0.5 cubic feet per second and it is necessary to allow for overtopping to prevent flooding.
- The tube and filler for organic filter tubes shall be in accordance with the criteria in [Section 3.6 Organic Filter Tube](#).
- Bags used to secure inlet protection devices on pavement shall be filled with aggregate, filter stone, or crushed rock that is less likely than sand to be washed into an inlet if the bag is broken. Filled bags shall be 24 to 30 inches long, 16 to 18 inches wide, and 6 to 8 inches thick. Bags shall be polypropylene, polyethylene, or polyamide woven fabric with a minimum unit weight of 4 ounces per square yard and meet the following criteria:
  - Greater than 300 psi Mullen Burst Strength using ASTM D3786 Standard Test Method for Hydraulic Bursting Strength of Textile Fabrics-Diaphragm Bursting Strength Tester Method.
  - Greater than 70 percent UV Stability using ASTM D4355 Standard Test Method for Deterioration of Geotextiles by Exposure to Light, Moisture, and Heat in a Xenon Arc Type Apparatus.

### **Curb Inlet Protection**

- Municipality approval is required before installing inlet protection on public streets.
- Special caution must be exercised when installing curb inlet protection on publicly traveled streets or in developed areas. Ensure that inlet protection is properly designed, installed and maintained to avoid flooding of the roadway or adjacent properties and structures.
- A two inch overflow gap or weir is required on all curb inlet protection devices.
- Traffic cones, warning signs, or other measures shall be installed to warn motorists when the inlet protection measures extend beyond the gutter line.
- 2 inch X 4 inch Weir Protection:
  - Bend wire mesh around the 2 inch x 4 inch board and staple to the board. Bend wire mesh around the bottom of the board, the curb opening, and along the pavement to form a cage for the rock.
  - Rock bags shall be placed perpendicular to the curb, at both ends of the wooden frame, to disrupt the flow and direct water into the rock filter. Stack the bags two high if needed.
- Organic Filter Tube Protection:
  - The diameter of the tube shall be at least 2 inches less than the height of the inlet opening. The tube should not be allowed to block the entire opening, since it will clog.
  - The tube shall be placed on 4 inch x 4 inch or 2 inch x 4 inch wire mesh to prevent the tube from sagging into the inlet.
  - The tube should be long enough to extend a minimum of 12 inches past the curb opening on each side of the inlet.
- Hog Wire Weir Protection:
  - The filter fabric and wire mesh shall extend a minimum of 12 inches past the curb opening on each side of the inlet.
  - Filter fabric shall be placed on 2 inch x 4 inch wire mesh to prevent the tube from sagging into the inlet.
  - Rock bags are used to hold the wire mesh and filter fabric in contact with the pavement. At least one bag shall be placed on either side of the opening, parallel to and up against the concrete curb. The bags are intended to disrupt and slow the flow and ensure it does not go under the fabric. Add bags if needed.

- If a board is used to anchor the wire mesh and fabric instead of rock bags, the board shall be secured with concrete nails at 3 inches on center. Upon removal clean any dirt or debris from the nailing locations, apply chemical sanding agent, and apply non-shrink grout flush with surface of concrete.
- Block and Gravel Protection:
  - Concrete blocks shall be standard 8 inch x 8 inch x 16 inch concrete masonry units and shall be in accordance with ASTM C139, Concrete Masonry Units for Construction. Filter gravel shall be ¾ inch washed stone containing no fines. Angular shaped stone is preferable to rounded shapes.
  - Concrete blocks are to be placed on their sides in a single row around the perimeter of the inlet, with ends abutting. Openings in the blocks should face outward, not upward. ½ inch x ½ inch wire mesh shall then be placed over the outside face of the blocks covering the holes. Filter gravel shall then be piled against the wire mesh to the top of the blocks with the base of the stone being a minimum of 18 inches from the blocks.
  - Alternatively, where loose stone is a concern (streets, etc.), the filter gravel may be placed in appropriately sized filter fabric bags.
  - Periodically, when the gravel filter becomes clogged, the gravel must be removed and cleaned in a proper manner or replaced with new gravel and piled back against the wire mesh.
- Organic Filter Tube On-Grade Protection:
  - Organic filter tubes may be used to provide sediment control at on-grade curb inlets where the tube will not be a traffic hazard, such as on residential streets where the pavement adjacent to the curb is allocated to parked cars. Tubes should not be used in this manner where they will extend into an active travel lane.
  - The filter tube shall be secured in a U-shape by rock bags. Runoff flowing in the gutter will pond within the U until it filters through the tube or overflows around the end.
- Inlet protection shall be phased on curb inlets being constructed. Controls shall be installed on the pipe inlet at the bottom of the catch basin as soon as it is installed and while the inlet box and top are being formed or placed.

## Area Inlet Protection

- Installation methods for protection on area inlets vary depending on the type of inlet (drop, “Y,” or other) and the type and use of the surface surrounding the inlet (parking lot, playground, etc.). It is the responsibility of the designer to appropriately adapt inlet protection measures and their installation methods for each site condition. Several types may be needed on one project.
- Filter Fabric Protection:
  - Filter fabric protection is appropriate where the drainage area is less than one acre and the basin slope is less than five (5) percent. Filter fabric, posts, and wire mesh shall meet the material requirements specified in [Section 3.10 Silt Fence](#).
  - A 6 inch wide trench is to be cut 6 inches deep at the toe of the fence to allow the fabric to be laid below the surface and backfilled with compacted earth or gravel. This entrenchment prevents any bypass of runoff under the fence.
  - Stone overflow structures, according to the criteria in [Section 3.10 Silt Fence](#) shall be installed where flow to the inlet is concentrated and more than 1 cubic feet per second.
- Excavated Impoundment Protection:
  - Excavated inlet protection is usually the most effective type of area inlet protection; however, it is only applicable to drop inlets. It should not be applied to Y inlets because it will undermine the concrete pad surrounding the inlet opening. Nor can it be used for inlets on pavement.

- With this protection method, it is necessary to install weep holes to allow the impoundment to drain completely.
- The impoundment shall be sized such that the volume of excavation is equal to or exceeds the runoff volume from the temporary control design storm (2-year, 24-hour) for the inlet's drainage area.
- The trap shall have a minimum depth of one foot and a maximum depth of 2 feet as measured from the top of the inlet and shall have side slopes of 2:1 or flatter.
- Block and Gravel Protection:
  - Block and gravel inlet protection is the most stable area inlet protection and can handle more concentrated flows. It may be installed on paved or vegetated surfaces. Loose stone shall be carefully removed from vegetated surfaces at the end of construction to prevent the stone from becoming a mowing hazard.
  - The inlet protection may be one or two blocks high. Single block heights are applicable for drainage areas up to 3 acres in size. The double block height shall be used for larger drainage areas.
  - Concrete blocks shall be standard 8 inch x 8 inch x 16 inch concrete masonry units and shall be in accordance with ASTM C139, Concrete Masonry Units for Construction. Filter gravel shall be ¾ inch washed stone containing no fines. Angular shaped stone is preferable to rounded shapes.
- Organic Filter Tube Protection:
  - Organic filter tubes may be used on paved or unpaved surfaces.
  - On paved surfaces, tubes shall be secured in place by rock bags. On unpaved surfaces, the tubes shall be embedded in the ground a minimum of 3 inches and staked at 4 foot spacing.
  - Designer shall provide calculations and specify the diameter of tube to be used based on the inlet's drainage area and the flow rate of runoff to the inlet. The minimum allowable diameter is 12 inches.

### Proprietary Inlet Protection

- Numerous proprietary protection devices are available from commercial vendors. The devices often have the advantage of being reusable on several projects if they are maintained in good condition.
- It is the policy of this manual not to recommend any specific commercial vendors for proprietary controls. However, this subsection is included in order to provide municipalities with a rationale for approving the use of a proprietary inlet protection device within their jurisdiction.
- The designer shall work with the supplier to provide the municipality with flow calculations or independent third-party tests that document the device's performance for conditions similar to the ones in which it is proposed to be installed. The conditions that should be considered include: type and size of inlet, inlet configuration, size of contributing drainage area, design flow rate, soil particle sizes to be removed, and other pollutants to be removed.
- The designer or vendor of the proprietary device shall provide a minimum of three references for projects where the device has been installed and maintained in operation at a construction site for at least six months. Local references are preferred; but references from other regions can be accepted if a similarity between the reference project and the proposed application can be demonstrated.
- Proprietary devices must not completely block the inlet. The device shall have a minimum of a 2 inch wide opening for the length of the inlet when it will be used in areas that water can safely pond to depths deeper than the design depths for the inlet. If ponding is not an option, then the device must have overflow capacity equal to the inlet design flow rate.
- Some proprietary devices are available with replaceable pads or filters. These pads or filters have the added benefit of removing pollutants such as metals and oils in addition to removing sediment.



These types of inserts are recommended in applications where prior or current land use in or adjacent to the construction areas may result in the discharge of pollutants.

- Proprietary protection devices shall be in accordance with the General criteria at the beginning of this section and any criteria listed under Curb Inlet Protection and Area Inlet Protection that are not specific to an inlet protection method.

### 3.4.4 *Design Guidance and Specifications*

Specifications for construction of this item may be found in the Standard Specifications for Public Works Construction – North Central Texas Council of Governments, Section 201.15 Inlet Protection.

### 3.4.5 *Inspection and Maintenance Requirements*

Inlet protection should be inspected regularly (at least as often as required by the TPDES Construction General Permit). Inlet controls should also be inspected after every storm event to check for collapse into the inlet or other damages that may block flow in the inlet. In addition to routine inspection, inlet protection devices should be observed and monitored during larger storm events to verify that they are not ponding or diverting water in a manner that floods a roadway or damages property.

Floatable debris and other trash caught by the inlet protection should be removed after each storm event. Sediment should also be removed from curb inlet protection after each storm event because of the limited storage area associated with curb inlets.

Sediment collected at area inlet protection should be removed before it reaches half the height of the protection device. Sediment should be removed from inlets with excavated impoundment protection before the volume of the excavation is reduced by 50 percent. In addition, the weep holes should be checked and kept clear of blockage.

Concrete blocks, 2 inch x 4 inch boards, stakes, and other materials used to construct inlet protection should be checked for damaged and repaired or replaced if damaged.

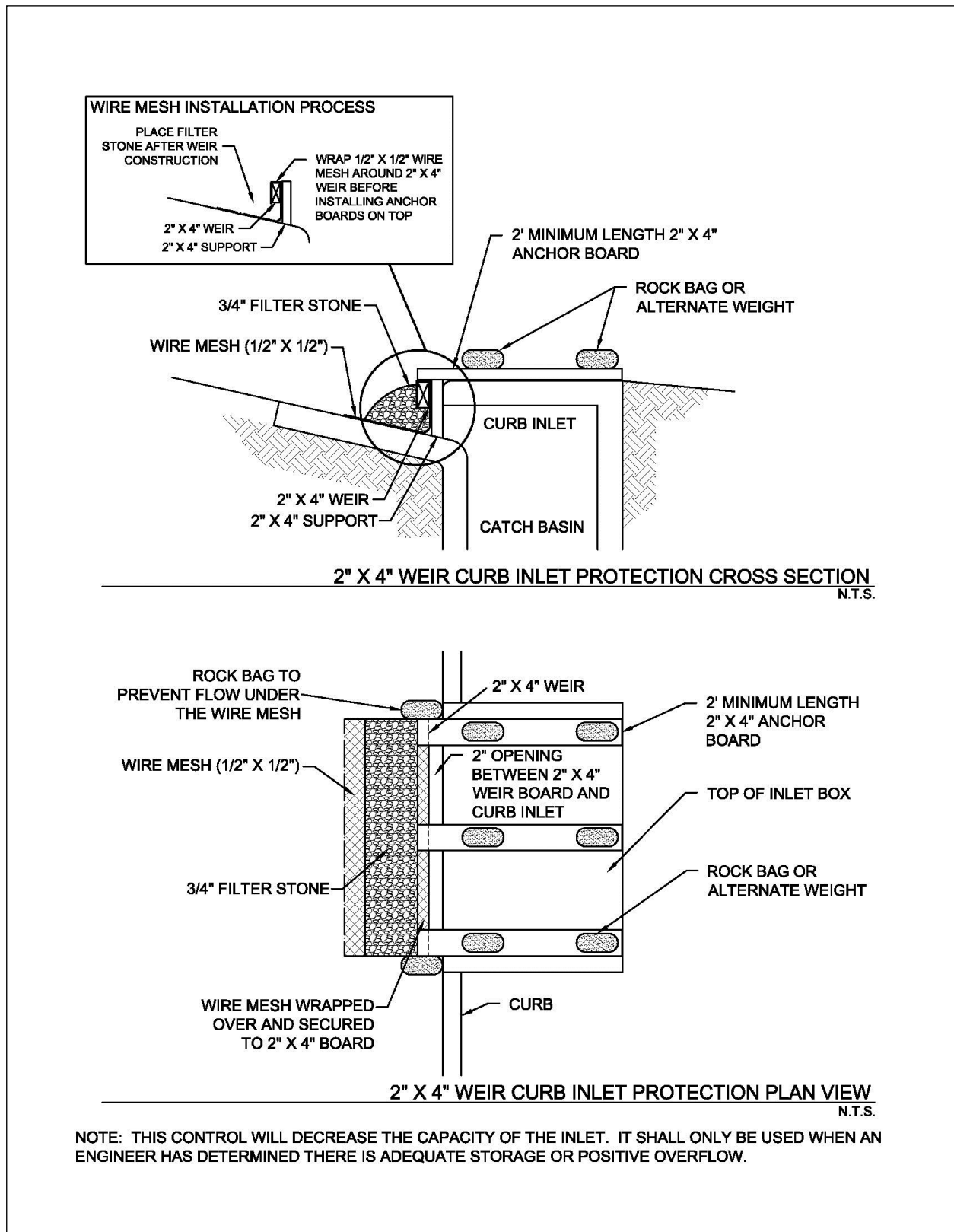
When filter fabric or organic filter tubes are used, they should be cleaned or replaced when the material becomes clogged. For systems using filter stone, when the filter stone becomes clogged with sediment, the stones must be pulled away from the inlet and cleaned or replaced.

Because of the potential for inlet protection to divert runoff or cause localized flooding, remove inlet protection as soon as the drainage area contributing runoff to the inlet is stabilized. Ensure that all inlet protection devices are removed at the end of the construction.

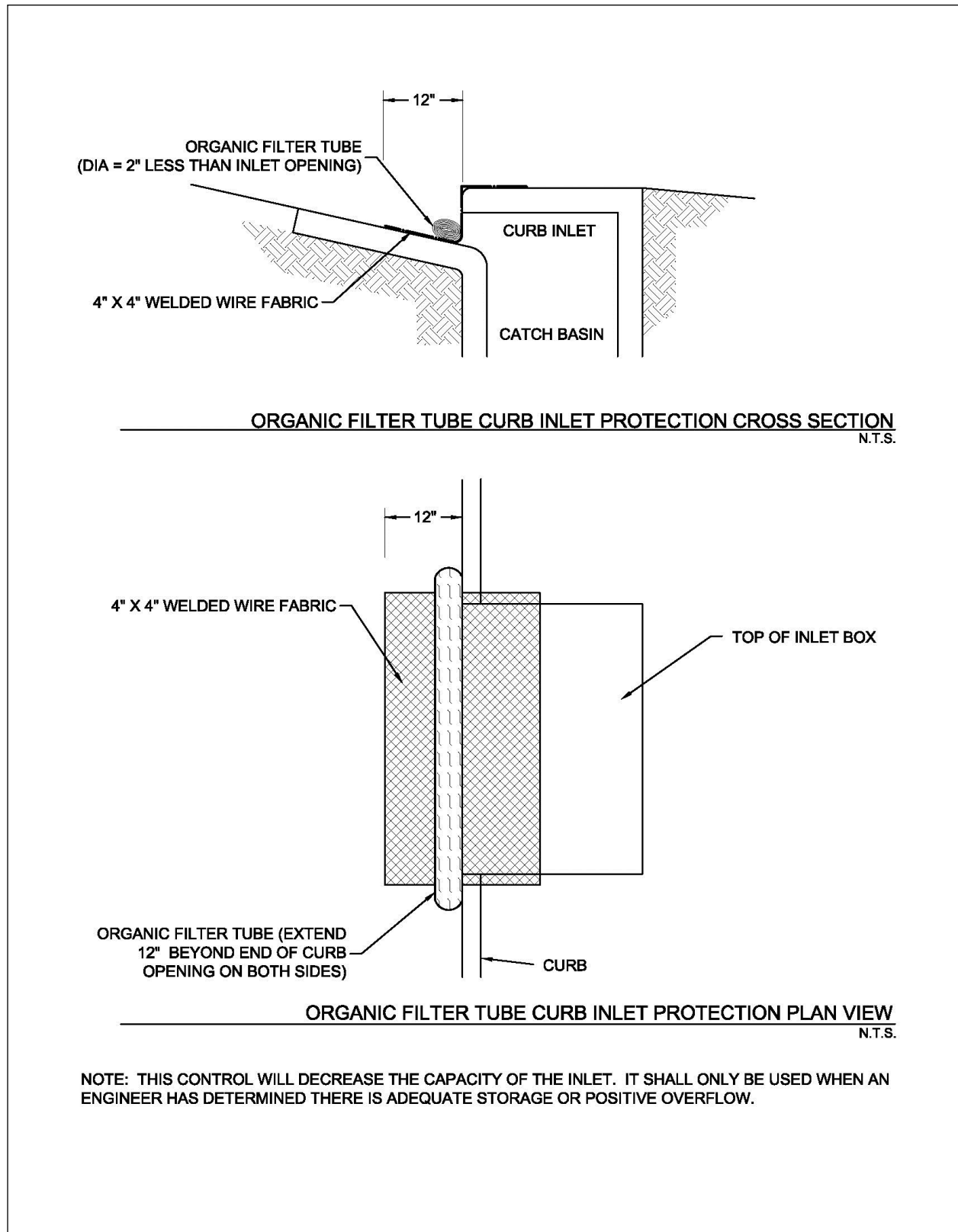
### 3.4.6 *Example Schematics*

The following schematics are example applications of the construction control. They are intended to assist in understanding the control's design and function.

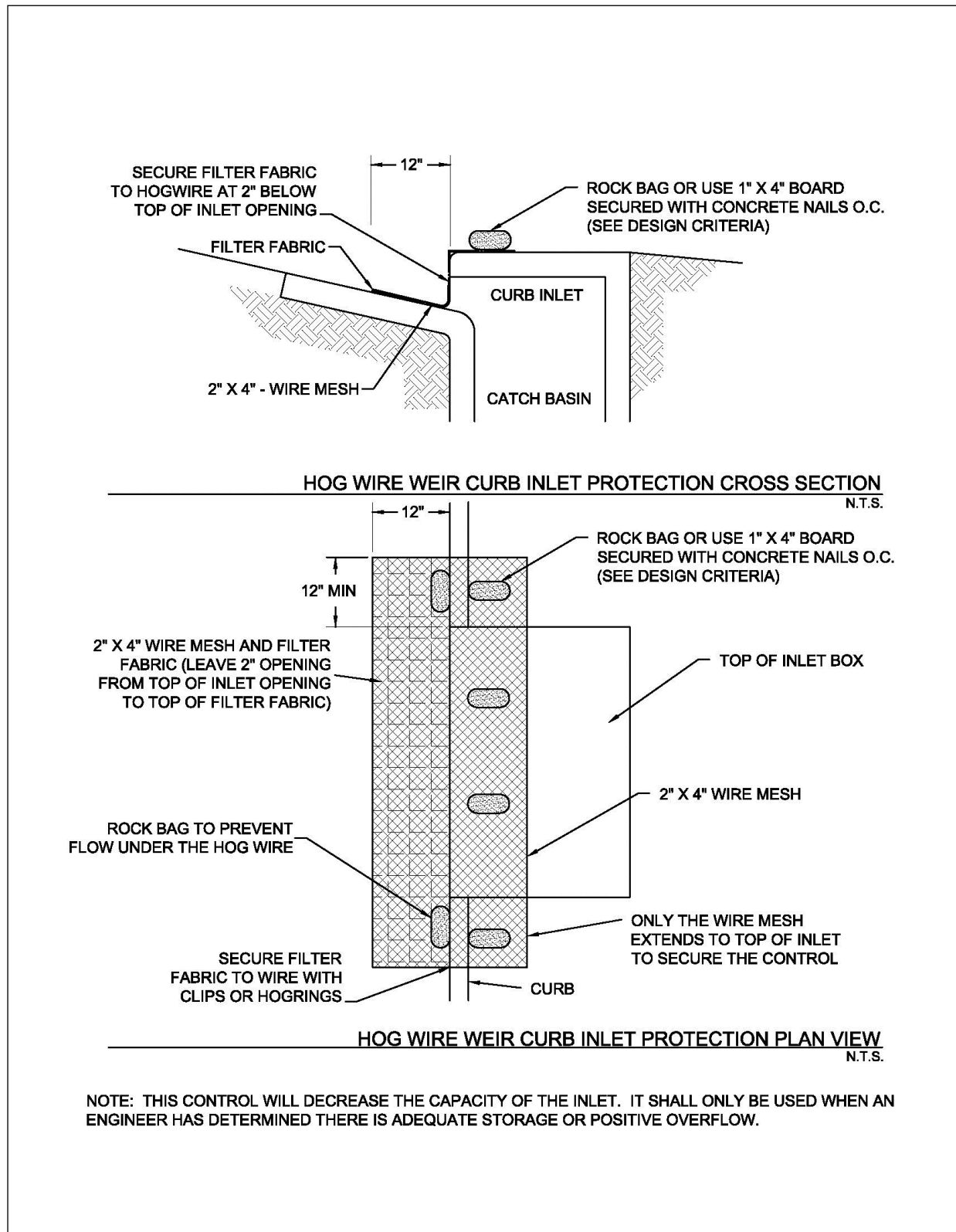
The schematics are **not for construction**. They may serve as a starting point for creating a construction detail, but they must be site adapted by the designer. In addition, dimensions and notes appropriate for the application must be added by the designer.



**Figure 3.5 Schematics of 2"x4" Weir Curb Inlet Protection**  
(Source: Modified from Washington Suburban Sanitary Commission Detail SC-16.0)

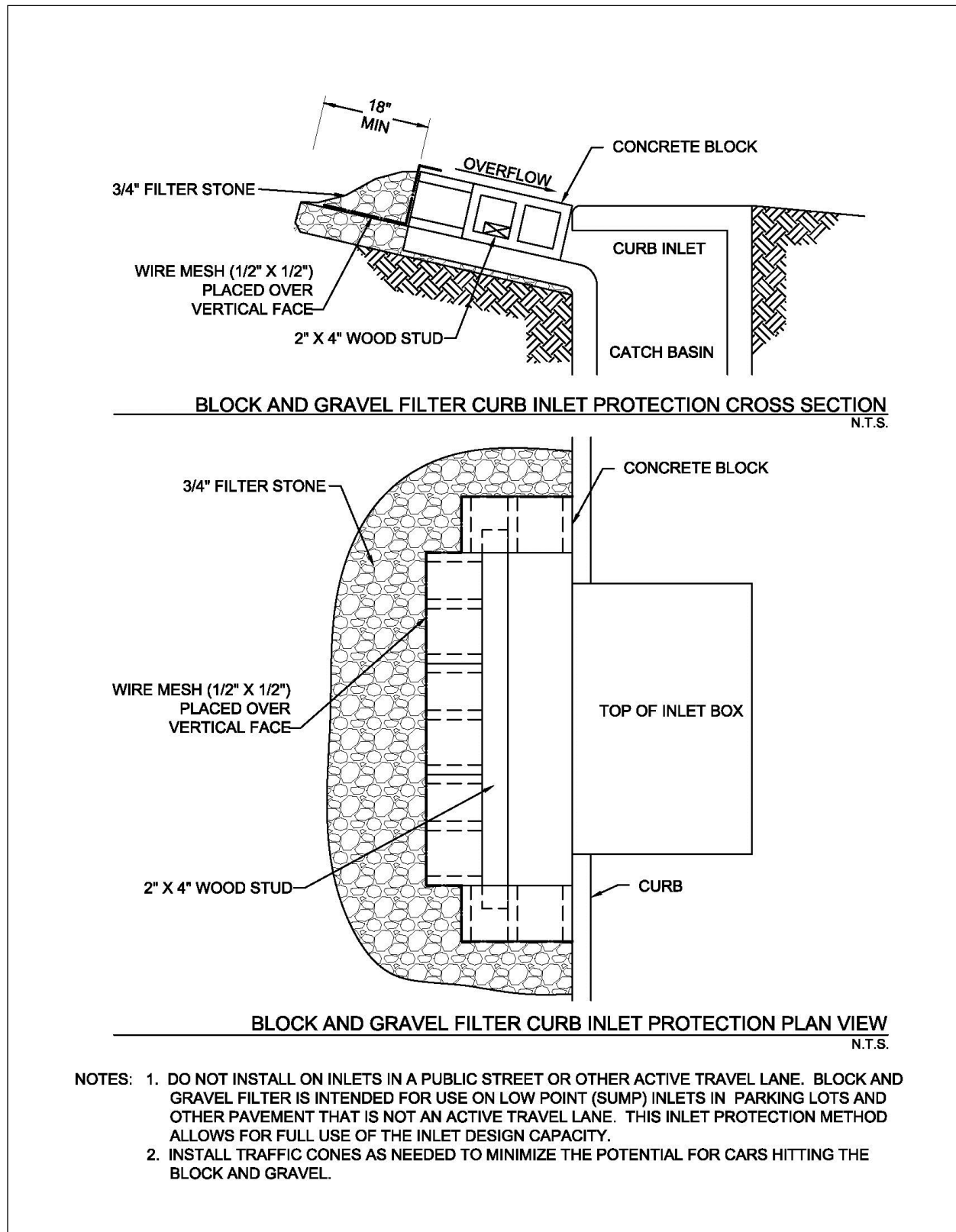


**Figure 3.6 Schematics of Organic Filter Tube Curb Inlet Protection**  
(Source: Modified from City of Plano BMP SP-4)

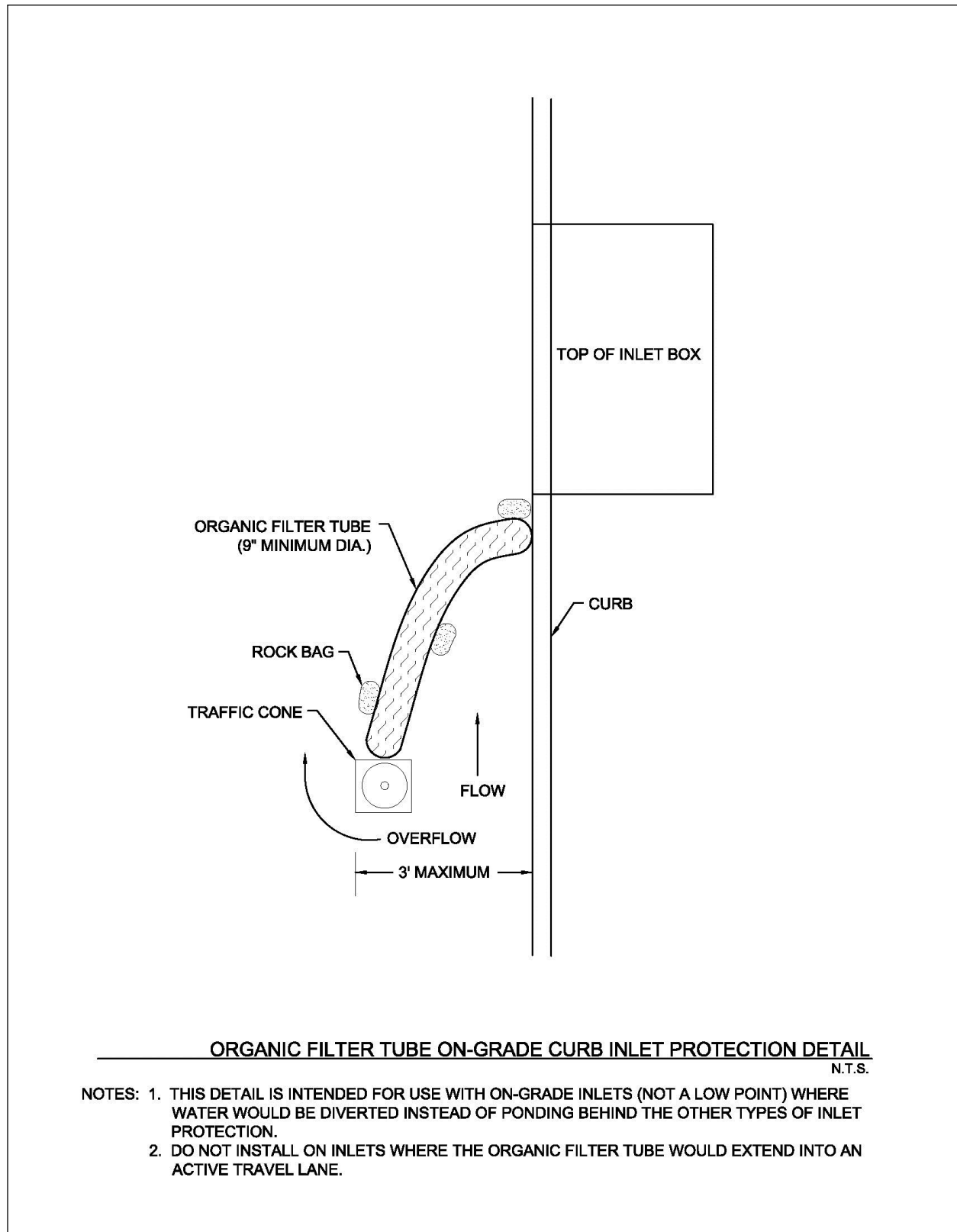


**Figure 3.7 Schematics of Hog Wire Weir Curb Inlet Protection**

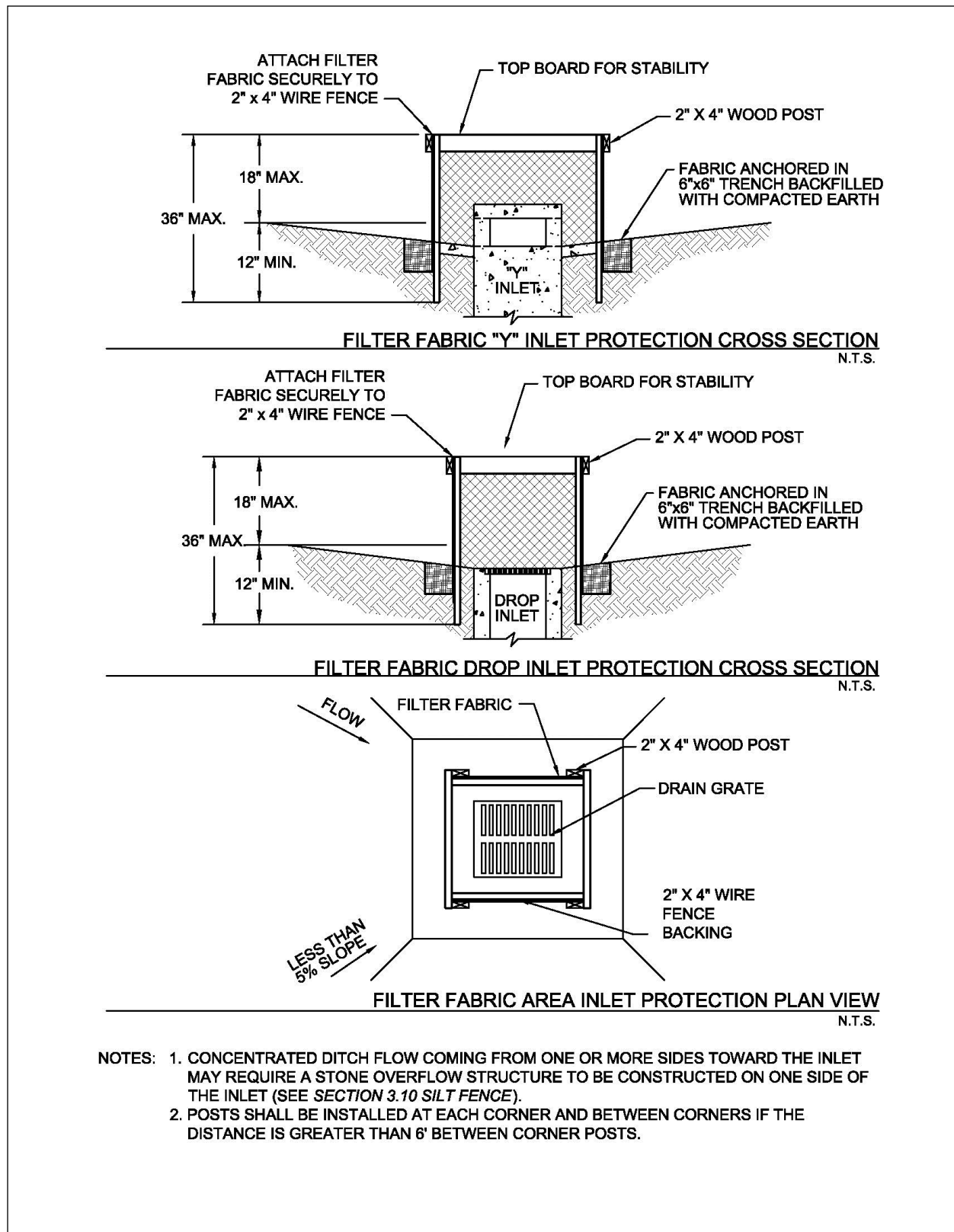
(Source: Modified from City of Round Rock Detail E-03)



**Figure 3.8 Schematics of Block and Gravel Filter Curb Inlet Protection**

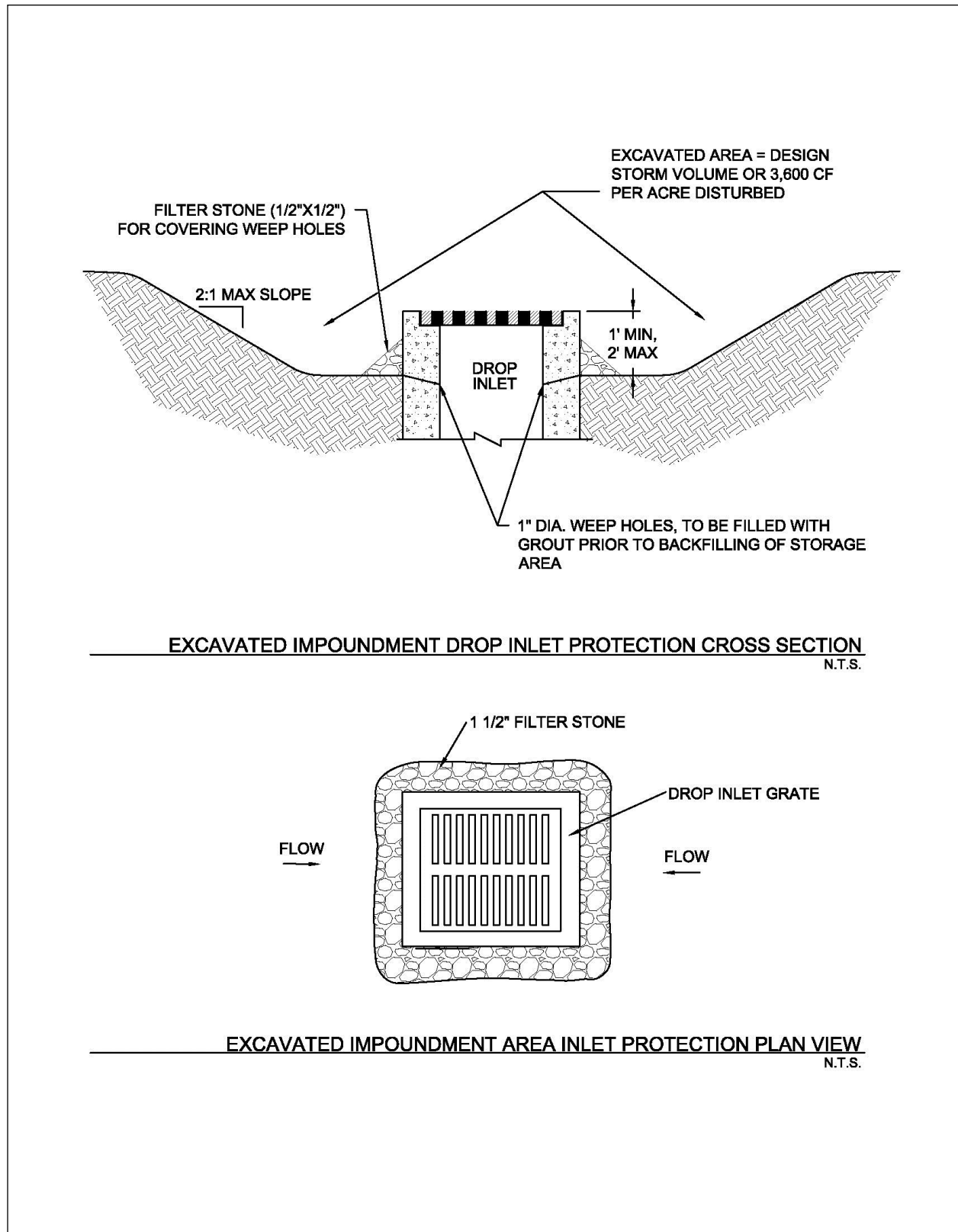


**Figure 3.9 Schematic of Organic Filter Tube On-Grade Curb Inlet Protection**



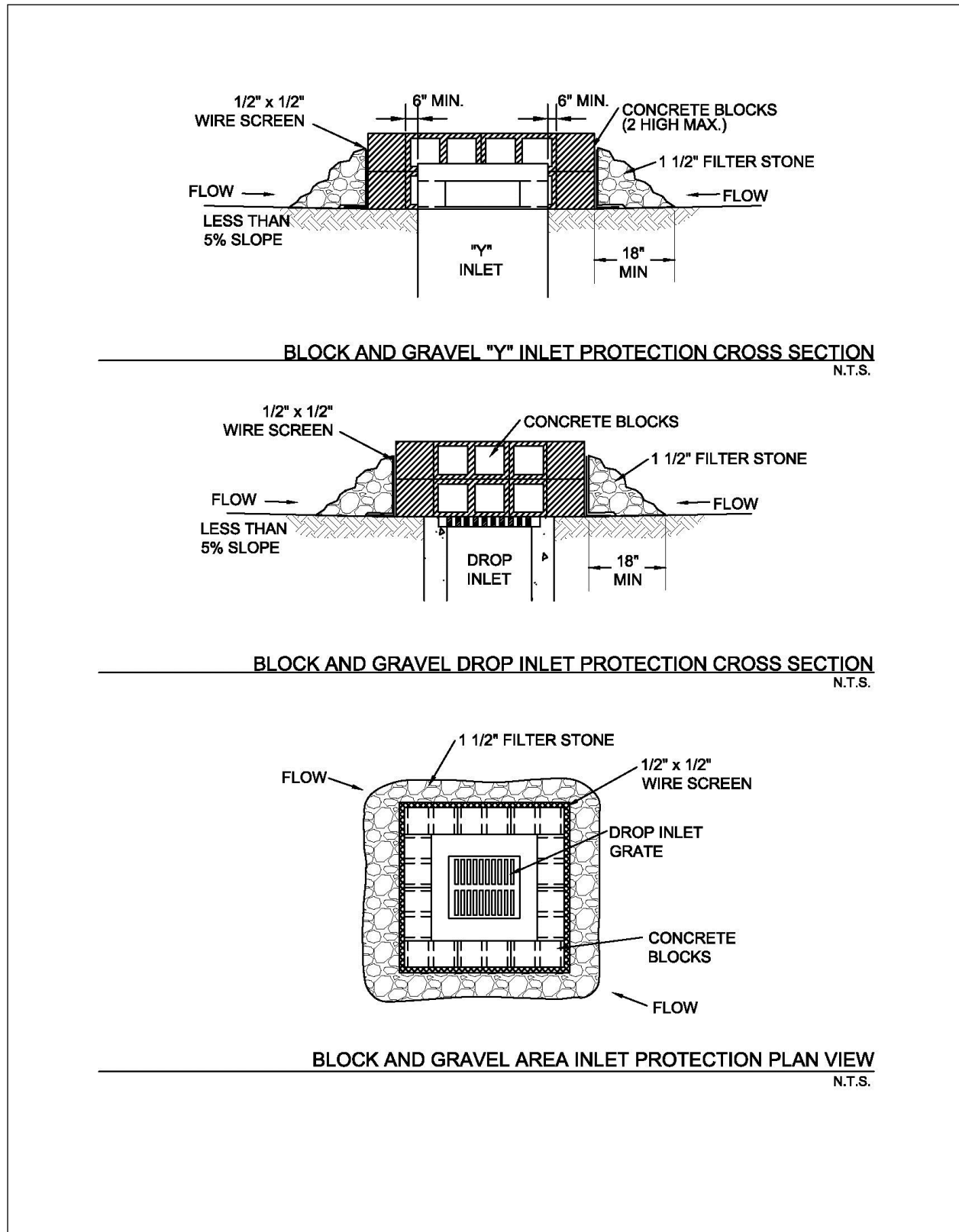
**Figure 3.10 Schematics of Filter Fabric Area Inlet Protection**

(Source: City of Plano BMP SP-4)



**Figure 3.11 Schematics of Excavated Impoundment Area Inlet Protection**





**Figure 3.12 Schematics of Block and Gravel Area Inlet Protection**

(Source: Modified from City of Plano BMP SP-4)

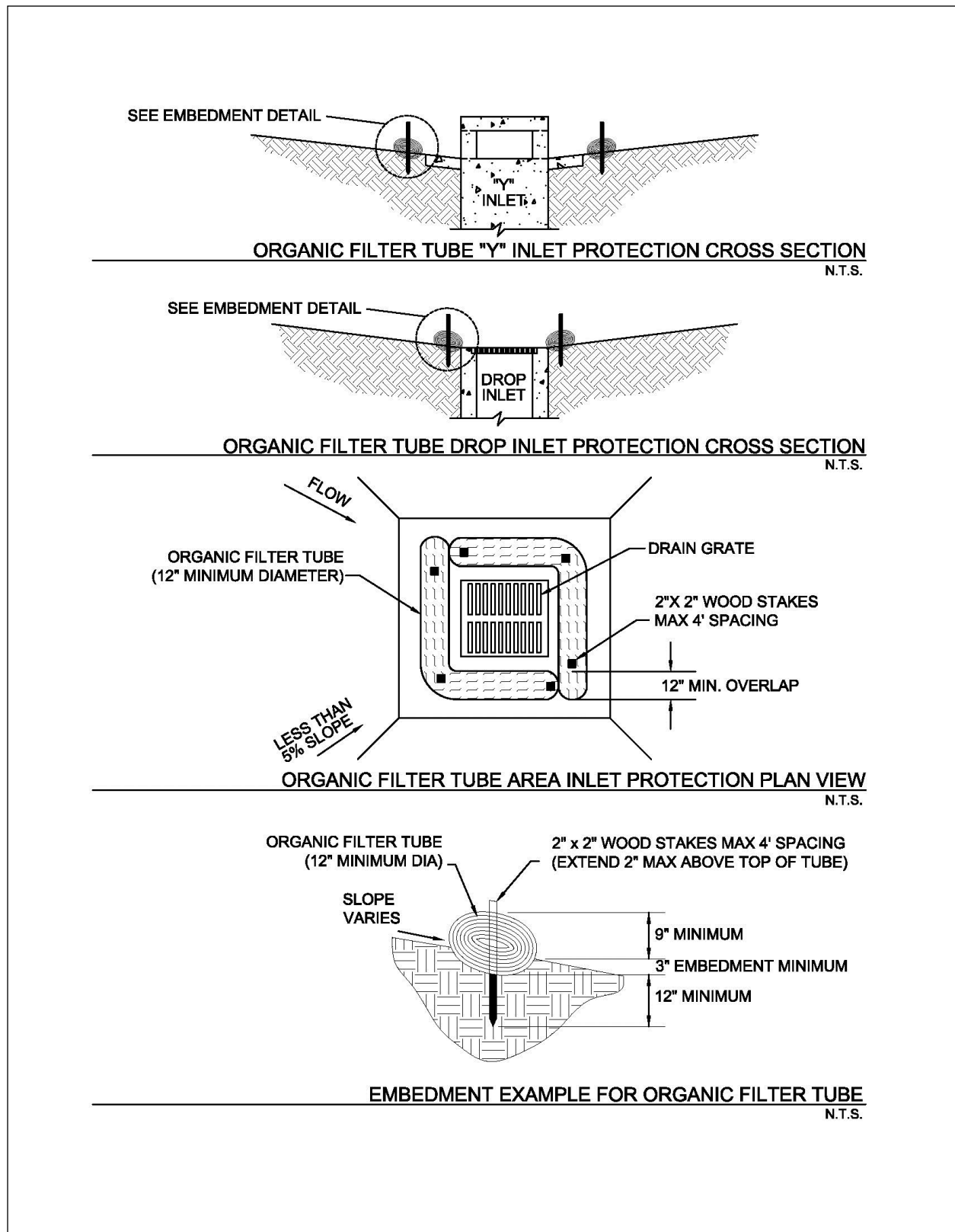
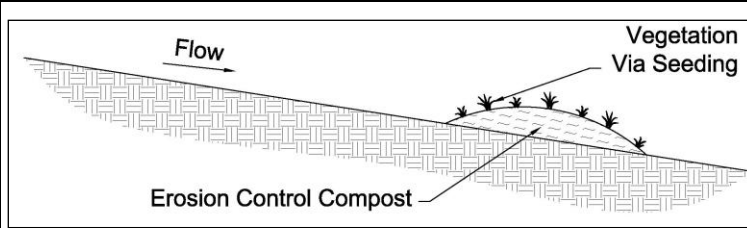


Figure 3.13 Schematics of Organic Filter Tube Area Inlet Protection

### 3.5 Organic Filter Berm

**Sediment Control**



**Description:** Organic filter berms, also called compost filter berms, are linear berms constructed of a mix of compost and wood chips. They are placed on a contour to control runoff. The organic filter berm provides both filtration and time for sediment settling by reducing the velocity of the runoff.

**KEY CONSIDERATIONS**

**DESIGN CRITERIA:**

- Maximum drainage area of 0.25 acre per 100 linear feet of berm
- Maximum 200 feet distance of flow to silt fence; 50 feet if slope exceeds 10 percent
- 1½ to 3 feet high, top width of 2 to 3 feet, and base of 3 to 5 feet for trapezoidal shaped berms
- 1 to 2 feet high and 2 to 4 feet wide for windrow (triangular) berms

**ADVANTAGES / BENEFITS:**

- Economical means to trap sediment
- Most effective with coarse to silty soil types
- May be tilled into the soil at end of project, thus adding organic content to the soil

**DISADVANTAGES / LIMITATIONS:**

- Localized flooding due to minor ponding upslope of the filter berm
- Not for use in swales or low areas where berms will be subject to concentrated flow
- Can interfere with construction operations
- Repeated clogging may require replacement of berm with another control

**MAINTENANCE REQUIREMENTS:**

- Inspect regularly
- Repair undercutting and other failures
- Remove sediment when before it reaches one-half the height of the berm
- Maintain dimensions of the berm by replacing organic filter material when necessary

**TARGETED POLLUTANTS**

- Sediment
- Nutrients & Toxic Materials
- Oil & Grease
- Floatable Materials
- Other Construction Wastes

**APPLICATIONS**

Perimeter Control
Slope Protection
Sediment Barrier

- Channel Protection
- Temporary Stabilization
- Final Stabilization
- Waste Management
- Housekeeping Practices

**Fe=0.50-0.75**

*(Depends on soil type)*

**IMPLEMENTATION CONSIDERATIONS**

- Capital Costs
- Maintenance
- Training
- Suitability for Slopes > 5%

**Other Considerations**

- *Effects of ponding on adjacent areas and property*

### 3.5.1 Primary Use

Organic filter berms are used as perimeter controls down slope of disturbed areas and on side slopes where stormwater may runoff the area. They are very well suited to sites with small disturbed drainage areas that are not subjected to concentrated flows and that will ultimately be seeded, sodded, or landscaped.

### 3.5.2 Applications

Properly designed, the organic filter berm is economical due to the ease of installation and because it can be tilled into the soil at the end of project, limiting the cost of removal and adding to the organic content of the soil. The berms are used as perimeter control devices for both development sites and linear (roadway) type projects. They are most effective with coarse to silty soil types. Additional controls, such as a passive treatment system, may be needed to remove fine silts and clay soils suspended in stormwater.

### 3.5.3 Design Criteria

- Filter berms are to be constructed along a line of constant elevation (along a contour line) where possible.
- Berms can interfere with construction operations; therefore planning of access routes onto the site is critical.
- Maximum drainage area shall be 0.25 acre per 100 linear feet of filter berm.
- Maximum flow to any 20 foot section of filter berm shall be 1 cubic feet per second.
- Maximum distance of flow to berm shall be 200 feet or less. If the slope exceeds 10 percent the flow distance shall be less than 50 feet.
- Maximum slope adjacent to the filter berm shall be 4:1.
- Trapezoidal shaped berms should be 1½ to 3 feet high with a top width of 2 to 3 feet and a base of 3 to 6 feet wide.
- Windrow (triangular) shaped berms should be 1 to 2 feet high and 2 to 4 feet wide.
- Berm side slopes shall be 2:1 or flatter.
- Roughen the soil surface before placing the berm to increase adherence of the compost.
- Compost shall conform to the requirements for Erosion Control Compost in Item 161 of the Standard Specifications for Construction and Maintenance of Highways, Streets, and Bridges (TxDOT 2004).
- Organic filter berms should be stabilized by seeding if there are no other sediment controls down slope of the filter berm. Seeding shall be as specified in [Section 2.9 Vegetation](#) at a seed loading of 1 lb. per 10 linear feet for small berms (1ft. by 2 ft.) or 2.25 lbs per 10 linear ft. for larger berms (1.5 ft. by 3 ft.)

### 3.5.4 Design Guidance and Specifications

Specifications for Erosion Control Compost to be used as filter material may be found in Item 161 of the Standard Specifications for Construction and Maintenance of Highways, Streets, and Bridges (TxDOT 2004).

### 3.5.5 Inspection and Maintenance Requirements

Filter berms should be inspected regularly (at least as often as required by the TPDES Construction General Permit) for buildup of excess sediment, undercutting, and other failures. Silt must be removed

when before it reaches half the height of the berm. Silt may be raked from the disturbed side of the device to clean side the berm for the first few times that it becomes clogged to prevent ponding. Repeated clogging of the berm at one location will require replacement of the organic filter material or may require installation of another control to prevent failure of the berm.

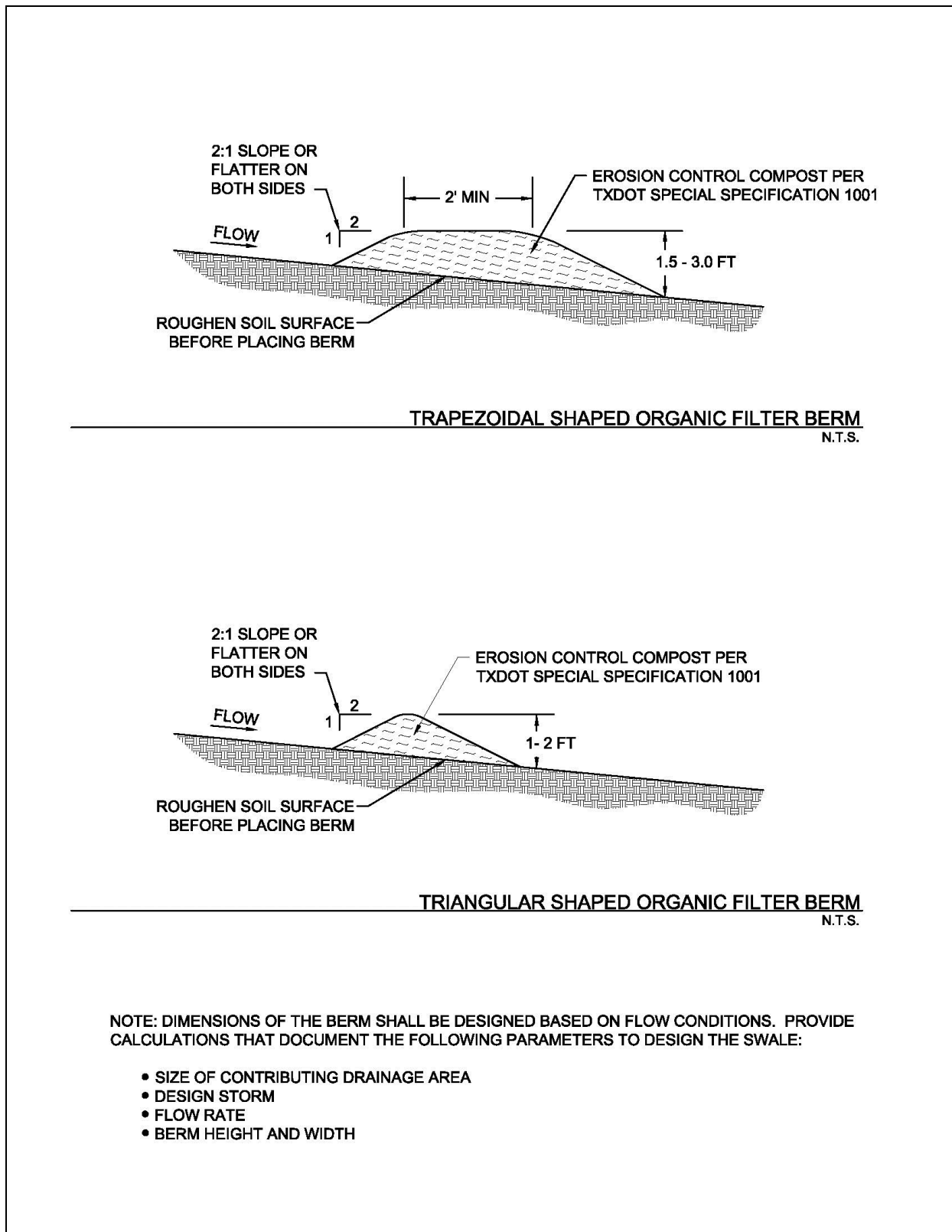
Dimensions of the berm must be maintained by replacing organic filter material when necessary. Typically excess material is stockpiled onsite for repairs to berms disturbed by construction activity.

There shall be no signs of erosion, breaching or runoff around or under the berm.

### **3.5.6** *Example Schematics*

The following schematics are example applications of the construction control. They are intended to assist in understanding the control's design and function.

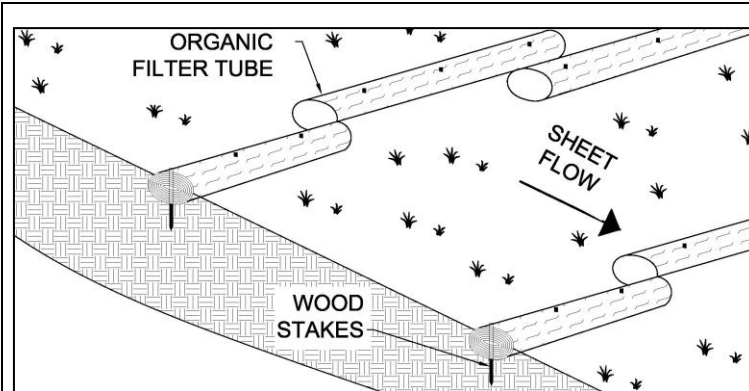
The schematics are **not for construction**. They may serve as a starting point for creating a construction detail, but they must be site adapted by the designer. In addition, dimensions and notes appropriate for the application must be added by the designer.



**Figure 3.14 Schematics of Organic Filter Berm**

### 3.6 Organic Filter Tubes

**Sediment Control**



**Description:** Organic filter tubes are comprised of an open weave, mesh tube that is filled with a filter material (compost, wood chips, straw, coir, aspen fiber, or a mixture of materials). The tube may be constructed of geosynthetic material, plastic, or natural materials. Organic filter tubes are also called fiber rolls, fiber logs, wattles, mulch socks, and/or coir rolls. Filter tubes detain flow and capture sediment as linear controls along the contours of a slope or as a perimeter control down-slope of a disturbed area.

**KEY CONSIDERATIONS**

**DESIGN CRITERIA:**

- Tube diameter when filled shall be specified on the plans
- 3 inch minimum embedment in soil
- 18 inch minimum overlap at ends of tubes
- Spacing based on drainage area and slope
- Must be staked on soil and secured with rockbags on pavement
- Turn ends of tube lines upslope a minimum of 10 feet

**ADVANTAGES / BENEFITS:**

- Effective means to treat sheet flow over a short distance
- Relatively easy to install
- May be used on steep slopes
- Can provide perimeter control on paved surfaces or where soil type prevents embedment of other controls
- Work well as perimeter controls around stockpiles

**DISADVANTAGES / LIMITATIONS:**

- Difficult to remove when wet and/or filled with sediment
- Relatively small effective areas for sediment capture

**MAINTENANCE REQUIREMENTS:**

- Inspect regularly
- Repair eroded areas underneath the organic filter tubes
- Re-align and stake tubes that are dislodged by flow
- Remove sediment before it reaches half the height of the exposed tube

**TARGETED POLLUTANTS**

- Sediment
- Nutrients & Toxic Materials
- Oil & Grease
- Floatable Materials
- Other Construction Wastes

**APPLICATIONS**

Perimeter Control
Slope Protection
Sediment Barrier

- Channel Protection
- Temporary Stabilization
- Final Stabilization
- Waste Management
- Housekeeping Practices

**Fe=0.50-0.75**

*(Depends on soil type)*

**IMPLEMENTATION CONSIDERATIONS**

- Capital Costs
- Maintenance
- Training
- Suitability for Slopes > 5%

**Other Considerations:**

- None

### 3.6.1 Primary Use

Organic filter tubes are long, flexible controls that are used along a line of constant elevation (along a contour) on slopes. They are used as perimeter controls down slope of disturbed areas, around temporary stockpiles and on side slopes where stormwater may runoff the area. The tubes maintain sheet flow, slow velocities, and capture sediment. When used in series on slopes, they also shorten the slope length and protect the slope from erosion.

### 3.6.2 Applications

Organic filter tubes include a wide variety of tube and filter materials. Organic filter tubes are used as a perimeter sediment barrier, similar to silt fence, for development projects and linear projects, such as roadways and utilities. They work well on individual residential lots and on lots being re-developed, where space may be limited. Organic filter tubes are most effective with coarse to silty soil types. Additional controls may be needed to remove fine silts and clay soils suspended in stormwater.

Organic filter tubes can be used on paved surfaces where it's not possible to stake a silt fence. Applications on paved surfaces include perimeter controls for soil stockpiles, pavement repair areas, utility trenching, and building demolition. When compost filter material is used in tubes on pavement, the material has the added benefit of removing some oil and grease from stormwater runoff.

Applications on slopes include temporary sediment control during construction and erosion control of the disturbed soil on the slope. Organic filter tubes may be used to control sheet flow on slopes when final stabilization measures are being applied and established.

Organic filter tubes may also be used for inlet protection and, in limited cases, as check dams in small drainage swales. Refer to [Section 3.4 Inlet Protection](#) and [Section 2.1 Check Dam](#) for the design criteria to use organic filter tubes in these applications.

### 3.6.3 Design Criteria

#### General Criteria

- Filter tubes should be installed along the contour.
- Tubes shall be staked with 2 inch by 2 inch wooden stakes at a maximum spacing of 4 feet. Rebar or similar metal stakes may be used instead of wooden stakes.
- When placed on pavement, sand or rock bags shall be placed abutting the down-slope side of the tubes to prevent runoff from dislodging the tubes. At a minimum, bags shall be placed one foot from each end of the tube and at the middle of the tube.
- Filter tubes shall be embedded a minimum of three inches when placed on soil. Placement on rock shall be designed as placement on pavement.
- The end of tubes shall overlap a minimum of 18 inches when multiple tubes are connected to form a linear control along a contour or a perimeter.
- Loose mulch material shall be placed against the log on the upstream side to facilitate contact with the ground.
- The last 10 feet (or more) at the ends of a line of tubes shall be turned upslope to prevent bypass by stormwater. Additional upslope lengths of tubes may be needed every 200 to 400 linear feet, depending on the traverse slope along the line of tubes.
- The most common sizes of tubes are 6 to 24 inches in diameter; however, tubes are available in sizes as small as 4 inches and up to 36 inches in diameter. The designer shall specify a diameter based on the site application. Tubes less than 8 inches in diameter when filled will require more frequent maintenance if used.



- Manufactured organic filter tube products shall have documentation of a minimum 75 percent soil retention using ASTM D7351 Standard Test Method for Determination of Sediment Retention Device Effectiveness in Sheet Flow Applications.
- When using manufactured tubes, the manufacturer's recommendations for diameter and spacing based on slope, flow velocities, and other site conditions shall be followed when they are more stringent than the design criteria in this section.
- When used as a perimeter control on grades of 10:1 or less, criteria in the following table shall be used as a guide for the size and installation rate of the organic filter tube.

**Table 3.1 Perimeter Control Applications\***

<i>Drainage Area (Max)</i>	<i>Max Flow Length to the Tube</i>	<i>Tube Diameter (Min)</i>
1/3 Acre per 100 feet	145 feet	18 inches
1/4 Acre per 100 feet	110 feet	15 inches
1/5 Acre per 100 feet	85 feet	12 inches
1/8 Acre per 100 feet	55 feet	9 inches

(Source: Modified and expanded from City of Plano Fact Sheet SP-13)

\*Applicable on grades of 10:1 or flatter.

- When installing organic filter tubes along contours on slopes, criteria in the following table shall be used as a general guide for size and spacing of the tubes. Actual tube diameter and spacing shall be specified by the designer. The designer shall consider the tube manufacturers recommendations, the soil type, flow volume on the slope, required performance life, and erosion control measures that may be used in conjunction with the tubes.

**Table 3.2 Maximum Spacing for Slope Protection**

<i>Slope (H:V)</i>	<i>Tube Diameter (Min)</i>			
	<i>9 Inches</i>	<i>12 Inches</i>	<i>18 Inches</i>	<i>24 Inches</i>
5:1 to 10:1	35 feet	40 feet	55 feet	60 feet
4:1	30 feet	40 feet	50 feet	50 feet
3:1	25 feet	35 feet	40 feet	40 feet
2:1	20 feet	25 feet	30 feet	30 feet
1:1	10 feet	15 feet	20 feet	20 feet

(Source: Modified and expanded from Iowa Statewide Urban Design and Specifications Standards for Filter Socks)

## Tube Material

- The designer shall specify the type of mesh based on the required life of the tube. At a minimum, the mesh shall have a rated life of one year under field conditions.
- If the tubes will be left onsite as part of the final stabilization, they must be constructed of 100 percent biodegradable jute, coir, sisal or similar natural fiber or 100 percent UV photodegradable plastic, polyester or geosynthetic material.
- Mesh tubes may be oval or round in cross-section.
- Mesh for the tubes shall be open and evenly woven. Size of weave openings shall be specified based on filter material. Openings may range from ½ inch for Erosion Control Compost to 2 inches for straw and coir.
- Mesh openings should not exceed ½ inch in diameter.

## Filter Material

- Different filter materials have different properties and will affect sheet flow differently. The designer shall specify the type of material to be used (or excluded) on a particular site.
- Straw filter material shall be Certified Weed Free Forage. The straw must be in good condition, air-dried, and not rotten or moldy.
- Compost shall conform to the requirements for Erosion Control Compost in Item 161 of the Standard Specifications for Construction and Maintenance of Highways, Streets, and Bridges (TxDOT 2004).
- Compost may provide some oil and grease removal; however, the large percentage of fines in compost will result in less filtering and more ponding of stormwater.
- Wood chips shall be 100 percent untreated chips and free of inorganic debris, such as plastic, glass, metal, etc. Wood chip size shall not be smaller than 1 inch and shall not exceed 3 inches in diameter. Shavings shall not be more than 5% of the total mass.

### 3.6.4 Design Guidance and Specifications

Specifications for Erosion Control Compost to be used as filter material may be found in Item 161 of the Standard Specifications for Construction and Maintenance of Highways, Streets, and Bridges (TxDOT 2004).

### 3.6.5 Inspection and Maintenance Requirements

Organic filter tubes should be inspected regularly (at least as often as required by the TPDES Construction General Permit). The filter tube should be checked to ensure that it is in continuous contact with the soil at the bottom of the embedment trench. Closely check for rill erosion that may develop under the filter tubes. Eroded spots must be repaired and monitored to prevent reoccurrence. If erosion under the tube continues, additional controls are needed.

Staking shall be checked to ensure that the filter tubes are not moving due to stormwater runoff. Repair and re-stake slumping filter tubes. Tubes that are split, torn or unraveling shall be repaired or replaced.

Check the filter tube material to make sure that it has not become clogged with sediment or debris. Clogged filter tubes usually lead to standing water behind the filter tube after the rain event. Sediment shall be removed from behind the filter tube before it reaches half the height of the exposed portion of the tube.

When sediment control is no longer needed on the site, the tubes may be split open and the filter material may be used for mulching during establishment of vegetation for final stabilization if it meets the criteria in [Section 2.5 Mulching](#).

### 3.6.6 Example Schematics

The following schematics are example applications of the construction control. They are intended to assist in understanding the control's design and function.

The schematics are **not for construction**. They may serve as a starting point for creating a construction detail, but they must be site adapted by the designer. In addition, dimensions and notes appropriate for the application must be added by the designer.

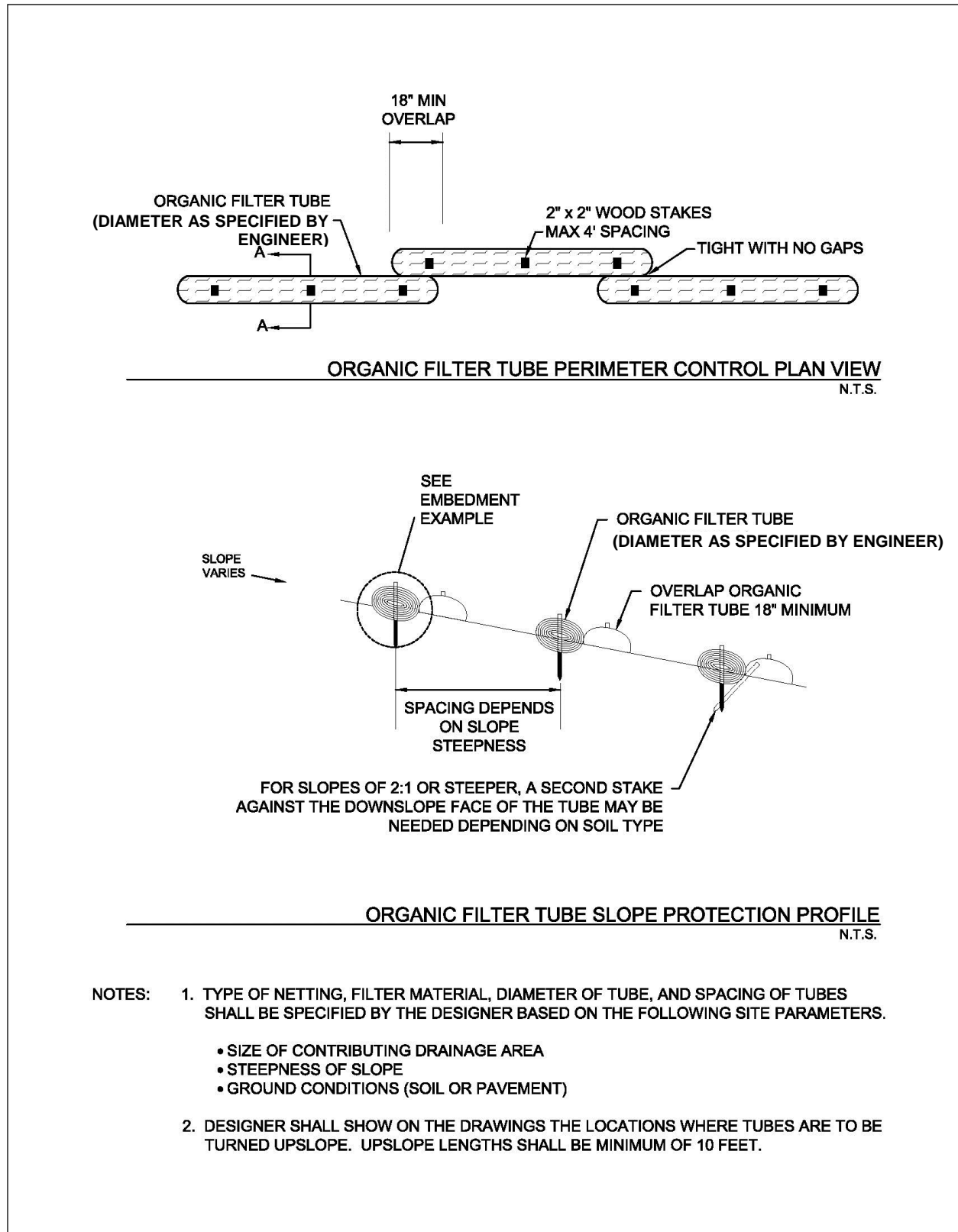
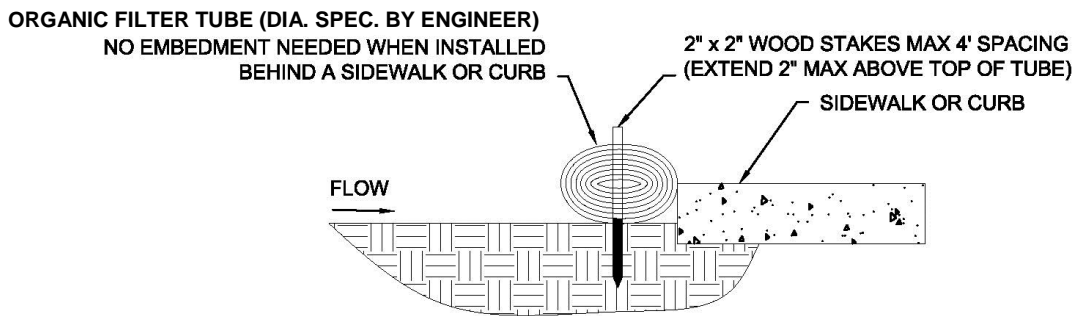
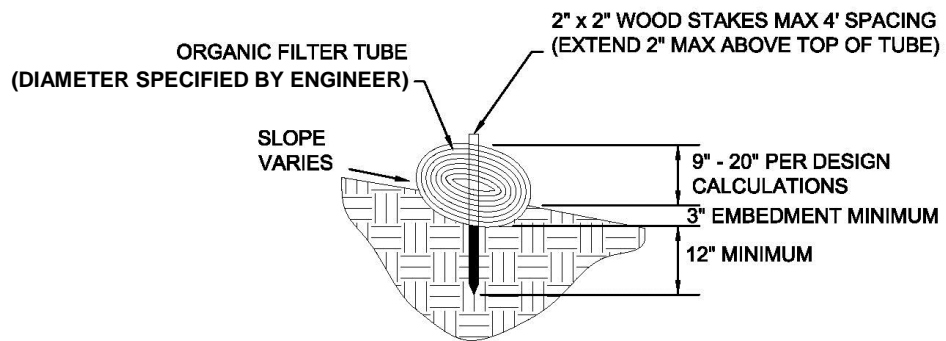


Figure 3.15 Schematics of Organic Filter Tubes



**INSTALLATION EXAMPLE FOR ORGANIC FILTER TUBE ABUTTING PAVEMENT**  
N.T.S.

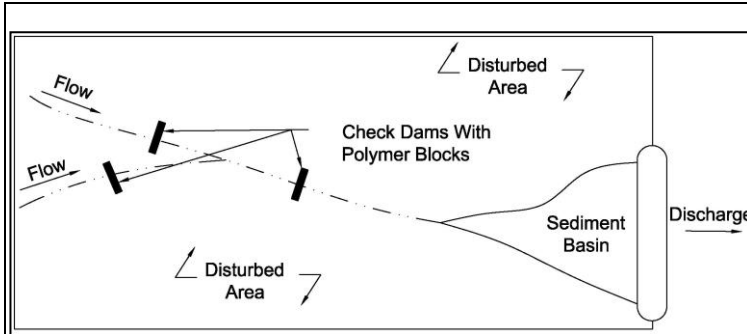


**EMBEDMENT EXAMPLE FOR ORGANIC FILTER TUBE**  
N.T.S.

**Figure 3.16 Examples of Organic Filter Tube Installation Methods**

### 3.7 Passive Treatment System (PTS)

**Sediment Control**



**Description:** Passive Treatment Systems (PTS) consist of adding polymers to traditional sediment controls. The polymers act as a coagulant to cause flocculation of fine silts and clay soil particles that are not typically removed by the traditional controls. PTS devices include polymer gel socks, floc blocks, floc logs, and surface applications of powder or liquid polymers.

**KEY CONSIDERATIONS**

**DESIGN CRITERIA:**

- Install in flowing water upstream of sediment barriers
- Do not install at perimeter controls
- Select polymers based on soil type
- Closely monitor performance after storm events and adjust based on results

**ADVANTAGES / BENEFITS:**

- Less expensive and easier to operate than an ATS
- Capable of producing discharges with turbidity less than 280 NTU when applied and managed properly
- Improves removal of fine silt and clay particles from stormwater
- Reduces size requirements for a sediment basin
- May be used with dewatering devices

**DISADVANTAGES / LIMITATIONS:**

- Does not produce a predictable level of sediment removal
- Unknown levels of residual chemicals may be in discharges
- Trial and error often required to achieve high removal rates without off-site impacts

**MAINTENANCE REQUIREMENTS:**

- Inspect after every storm event
- Reapply and/or adjust locations after each storm event

**APPLICATIONS**

- Perimeter Control
- Slope Protection
- **Sediment Barrier**
- Channel Protection
- Temporary Stabilization
- Final Stabilization
- Waste Management
- Housekeeping Practices

**Fe=0.85**

**IMPLEMENTATION CONSIDERATIONS**

- Capital Costs
- Maintenance
- Training
- Suitability for Slopes > 5%

**Other Considerations:**

- *Potential off-site impacts of over dosing*

**TARGETED POLLUTANTS**

- Sediment
- Nutrients & Toxic Materials
- Oil & Grease
- Floatable Materials
- Other Construction Wastes

### 3.7.1 Primary Use

Passive treatment systems (PTS) are used to remove fine silt and clay soil particles, for which traditional sediment controls are the least effective. These fine particles are small enough to pass through the pores or void spaces of sediment barriers. They are also not removed by sediment basins, because their settling velocities require a detention time of days or weeks, not hours.

### 3.7.2 Applications

Passive treatment systems are applicable on construction sites that have a large percentage of fine silt and clay soils. The site must have an internal system of berms, swales and control devices where the PTS can be applied.

A PTS functions similarly to an active treatment system (ATS); however, it trades lower cost for less consistency in removal rates. PTSs are applicable on sites where variability in the effluent characteristics is acceptable, such as where the discharge from the PTS will flow through a vegetated area before leaving the site, instead of directly to receiving waters. A PTS may also be a viable alternative to an ATS when the concentration of suspended solids in runoff is relatively low due to soil type or good erosion control measures on the site.

The systems are also applicable where discharge criteria are established for a construction site or discharges from a disturbed area have the potential to impact special aquatic sites or sensitive receiving waters. Examples of sensitive receiving waters include wetlands regulated under Section 404 of the Clean Water Act, spring-fed water bodies, water bodies with species protected under the Federal Endangered Species Act or the State of Texas Threatened and Endangered Species Regulations, or water bodies closely monitored by citizen groups.

### 3.7.3 Design Criteria

The passive use of polymers to enhance sediment removal is a relatively new and rapidly evolving science. The pace of new product development is expected to accelerate due to the demand that is being driven by the Effluent Limitation Guidelines and Standards for the Construction and Development Point Source Category, issued by the EPA on December 1, 2009. The following criteria are general guidelines. It is essential that the designer of controls for a construction activity develop the PTS specifications based on consultation with technical experts at the company supplying the polymer.

#### General

- Polymers are used for PTS function by altering the charge of soil particles to allow them to floc, or “clump” together. The flocs are then trapped as a soil mass by a traditional sediment control, instead of passing through pores or voids of the control as a suspended particle. This effect will more quickly clog the sediment barrier and require more frequent cleaning.
- Polymers are available in anionic (negatively charged), non-ionic (no charge), and cationic (positively charged) forms. The charged state of the soil to be treated should be known to specify the proper polymer. Clay soils are typically anionic.
- Numerous types of polymers are commercially available; however, polyacrylamide (PAM) and chitosan are effective and non-toxic in a wide range of applications. They are the safest for use in systems that are not being continuously monitored.
- Polymers are available in numerous formulations that will have varying rates of effectiveness depending on the soil type being treated. Jar tests may be used to determine the effectiveness of a particular formulation or to evaluate different formulations if the one being used is not producing the desired results. Jar tests should be conducted in accordance with ASTM D2035 Standard Practice for Coagulation-Flocculation Jar Test of Water.

- PTSs may produce fluctuating and unpredictable levels of residual polymer in stormwater discharged from the site. Either residual testing or the use of an ATS is advisable when an endangered, threatened, or other sensitive species is present in the receiving water.
- Areas downstream of the PTS shall be monitored for floc accumulation. Design is partially trial and error. The goal is to provide sufficient polymer to produce onsite settling of soil flocs while not providing excess polymer that results in a chemical residual being discharged to receiving waters.

### **Floc Blocks, Floc Logs and Gel Socks**

- Floc blocks and logs contain a solid form of polyacrylamide (PAM), a polymer that acts as a flocculating agent.
- Gel socks are a soft powder form of chitosan, a polymer that acts as a flocculating agent, contained within a fabric sock.
- The PTS should only be used in flowing water that is concentrated in swales or pipes. The turbulence of flowing water is necessary for mixing the polymer with the suspended soil.
- Swales and channels, upstream of a sediment basin, stone outlet sediment trap, check dam or other detention structure are effective locations for the PTS. This location gives the polymer time to mix before velocities are slowed by the sediment control, where the newly formed flocs can be settled or filtered.
- Removal rates increase proportionally with the distance the PTS is installed upstream of the sediment barrier. Longer distances correlate to higher removal rates.
- The PTS should be secured in a non-biodegradable mesh bag or galvanized wire cage, which in turn is securely anchored in a swale, channel, or pipe.
- The PTS should be installed in a manner that elevates above the ground at least six inches to minimize the potential for it to be in standing water a prolonged period of time.
- During long periods (weeks) of no precipitation, the floc blocks or logs that contain PAM may degrade from exposure to air and sunlight. In these situations, the blocks or logs should be replaced before the next predicted storm event. Alternatively, they may be removed during drought conditions to prevent their degradation, and then re-installed at the first forecast of precipitation.

### **Powder or Liquid Polymer**

- Powder or liquid polymer can be sprayed onto check dams, silt fences, organic filter tubes, and other permeable barriers. Polymer can also be sprayed onto filter fabric or erosion control blankets lining a swale. The polymer will mix with stormwater as it filters through of flows over the control.
- Polymer shall not be applied to perimeter controls, as this will result in flocs forming after the stormwater has been discharged from the site. Liquid polymer shall only be applied to sediment controls that are located within the disturbed areas and have a perimeter control or other sediment trap down slope to catch the flocs.
- Polymer should be re-applied after each storm event. If a long period passes between storm events, the polymer will break-down and should be re-applied.
- Liquid polymer may be injected into concentrated stormwater (swales, channels, etc.) upstream of sediment basins to improve the removal efficiency of the basin. The polymer is typically injected using a small metering pump that is calibrated for a pre-established dose based on the design flow for the temporary control design storm (2-year, 24-hour).
- Liquid polymer may also be injected into the pump intake of dewatering systems to provide a higher sediment removal rate for fine silt and clay soil particles. Criteria for dewatering are in [Section 3.3 Dewatering](#).

### *3.7.4 Design Guidance and Specifications*

No specification for construction of this item is currently available in the Standard Specifications for Public Works Construction – North Central Texas Council of Governments.

### *3.7.5 Inspection and Maintenance Requirements*

Passive treatment systems should be inspected regularly (at least as often as required by the TPDES Construction General Permit).

Floc blocks, floc logs, and gel socks should be checked after every storm event that produces stormwater runoff. Replace the PTS before it is completely dissolved. If the PTS is found to be submerged in standing water, it should be removed and re-installed at a new location where it will only be in contact with flowing stormwater.

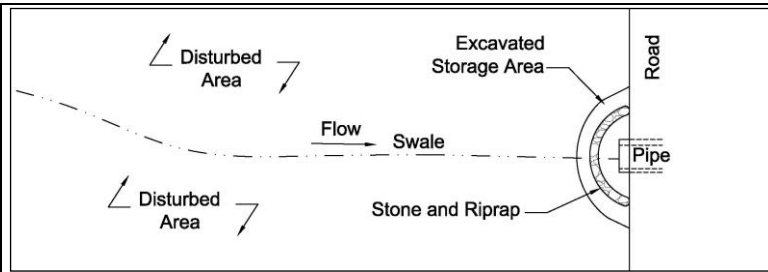
The site's discharge points and downstream drainage infrastructure and water bodies should be inspected for accumulations of soil flocs. If flocs are found off the construction site, the PTS is not being implemented at a point where there is sufficient flow distance and time for polymer mixing and floc removal, or too much polymer is being used. The off-site floc accumulation must be removed if doing so will not negatively impact the receiving water. Then, the location or application of the PTS should be modified to provide additional mixing, more time for removal, or a lower dose, as applicable. If modifying the PTS is not possible, then an ATS may be needed to meet the discharge conditions for which a PTS was being used.



### 3.8 Pipe Inlet Sediment Trap

(Source: Modified from City of Plano BMP SP-11)

**Sediment Control**



**Description:** The pipe inlet sediment trap is a barrier surrounding a pipe inlet to capture sediment before it enters a closed drainage system. The barrier may be made of concrete block and filter stone or stone riprap and filter stone. The barrier provides both filtration and detention for sediment to settle in the excavated area.

**KEY CONSIDERATIONS**

**DESIGN CRITERIA:**

- Top of control shall be no higher than half the pipe diameter
- Excavate a storage volume for the 2-year, 24-hour design storm upslope of the barrier
- Side slopes of 2:1 or flatter on the excavated storage area
- Maximum drainage area of 5 acres
- Overflow capability required for large storm events

**ADVANTAGES / BENEFITS:**

- Removes sediment before it enters a closed conveyance system

**DISADVANTAGES / LIMITATIONS:**

- Ponding upstream of the pipe inlet with localized flooding possible
- Type A Pipe Inlet Sediment Trap limited to pipes of 36 inches in diameter or less

**MAINTENANCE REQUIREMENTS:**

- Inspect regularly
- Remove trash and debris after each storm event
- Remove sediment from the sediment storage area before it reaches half the design depth
- If de-watering of the storage volume is not occurring, clean or replace the filter stone

**TARGETED POLLUTANTS**

- Sediment
- Nutrients & Toxic Materials
- Oil & Grease
- Floatable Materials
- Other Construction Wastes

**APPLICATIONS**

**Perimeter Control**

**Slope Protection**

**Sediment Barrier**

**Channel Protection**

**Temporary Stabilization**

**Final Stabilization**

**Waste Management**

**Housekeeping Practices**

**Fe=0.50-0.75**

*(Depends on soil type)*

**IMPLEMENTATION CONSIDERATIONS**

- Capital Costs
- Maintenance
- Training
- Suitability for Slopes > 5%

**Other Considerations:**

- *Re-grading and stabilization of the control area after construction*

### 3.8.1 Primary Use

The pipe inlet sediment trap is used to intercept and filter sediment from concentrated flows at the inlet to a pipe. Capturing sediment before it enters a closed conveyance system decreases the cost of cleaning and removing sediment from the system.

### 3.8.2 Applications

The pipe inlet sediment trap should be used where existing or proposed storm drain pipes or culverts are used prior to final stabilization of the area draining to the pipe inlet.

### 3.8.3 Design Criteria

- The pipe inlet sediment trap must be designed with overflow capability, since this control is used where pipe culverts collect relatively heavy concentrations of stormwater flows.
- The drainage area contributing runoff to the sediment trap shall be not larger than 5 acres.
- Type A pipe inlet sediment trap is limited to pipes of 36 inches diameter and smaller. Type B pipe inlet sediment trap should be used on larger pipes.
- A stormwater and sediment storage area shall be excavated upslope of the stone barrier. Minimum storage area volume should be the volume of runoff from the temporary control design storm (2-year, 24-hour). Caution should be exercised during excavation so as to not undermine the control structure or the pipe that is being protected.
- Side slopes surrounding the storage area shall be 2:1 or flatter.
- Top of stone and sediment storage created by the stone shall not be any higher than half of the inlet pipe diameter. On Type A Pipe Inlet Sediment Trap, the concrete blocks shall not be stacked any higher than two blocks high.
- Concrete blocks shall be standard 8"x8"x16" concrete masonry units and shall be in accordance with ASTM C139, Concrete Masonry Units for Construction.
- Wire fabric shall be a standard galvanized hardware fabric with ½ inch by ½ inch openings.
- Filter stone shall be nominal 1½ inch washed stone with no fines. Angular shaped stone is preferable to rounded shapes.
- Stone riprap shall be 6 inch to 12 inch well-graded stone, Dry Riprap, Type A.
- Riprap shall be placed on filter fabric meeting the following minimum criteria:
  - Tensile Strength, ASTM D4632 Test Method for Grab Breaking Load and Elongation of Geotextiles, 250-lbs.
  - Puncture Rating, ASTM D4833 Test Method for Index Puncture Resistance of Geotextiles, Geomembranes, and Related Products, 135-lbs.
  - Mullen Burst Rating, ASTM D3786 Standard Test Method for Hydraulic Bursting Strength of Textile Fabrics-Diaphragm Bursting Strength Tester Method, 420-psi.
  - Apparent Opening Size, ASTM D4751 Test Method for Determining Apparent Opening Size of a Geotextile, U.S. Sieve No. 20 (max).
- The pipe inlet sediment trap is most effective with coarse silt and sand soil particles. A passive treatment system may be used with the sediment trap to remove fine silt and clay soil particles.

### 3.8.4 *Design Guidance and Specifications*

Specifications for the riprap used in this item may be found in the Standard Specifications for Public Works Construction – North Central Texas Council of Governments, Section 803.3 Riprap.

### 3.8.5 *Inspection and Maintenance Requirements*

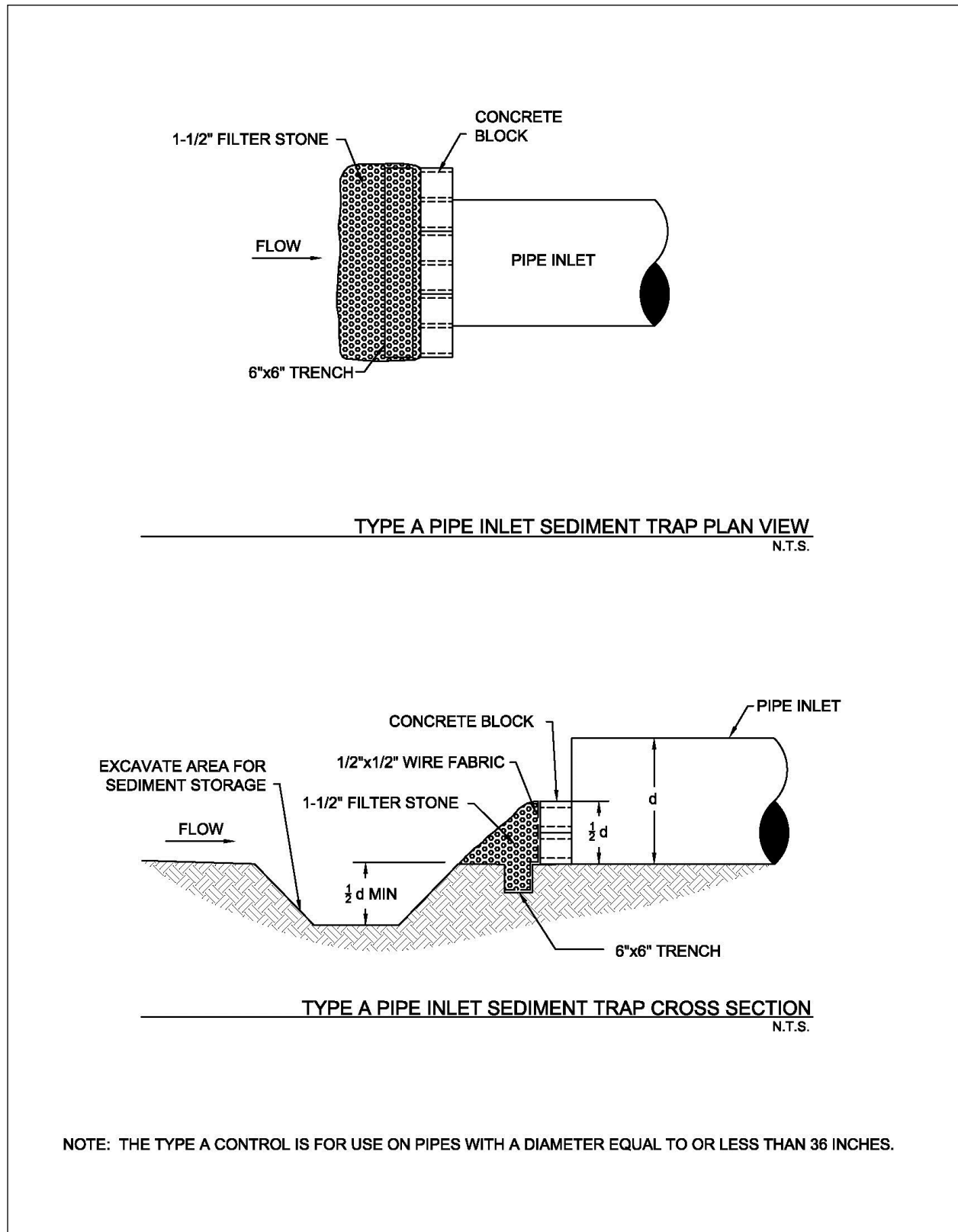
The pipe inlet sediment trap should be inspected regularly (at least as often as required by the TPDES Construction General Permit) to ensure that the device is functioning properly. The controls should also be checked after storm events to verify it's operating properly and to inspect for damages. Make repairs as needed.

Trash and debris should be removed from the trap after each storm event to prevent it from plugging the rock. Remove sediment from the storage area before the depth of sediment is half of the design depth. If the sediment storage area is not being de-watered, the filter stone surrounding the pipe inlet must be cleaned or replaced. Cleaning the filter stone surface the first few times by raking may be adequate. Repeated sediment build-up and clogging of the stone will require filter stone removal and replacement.

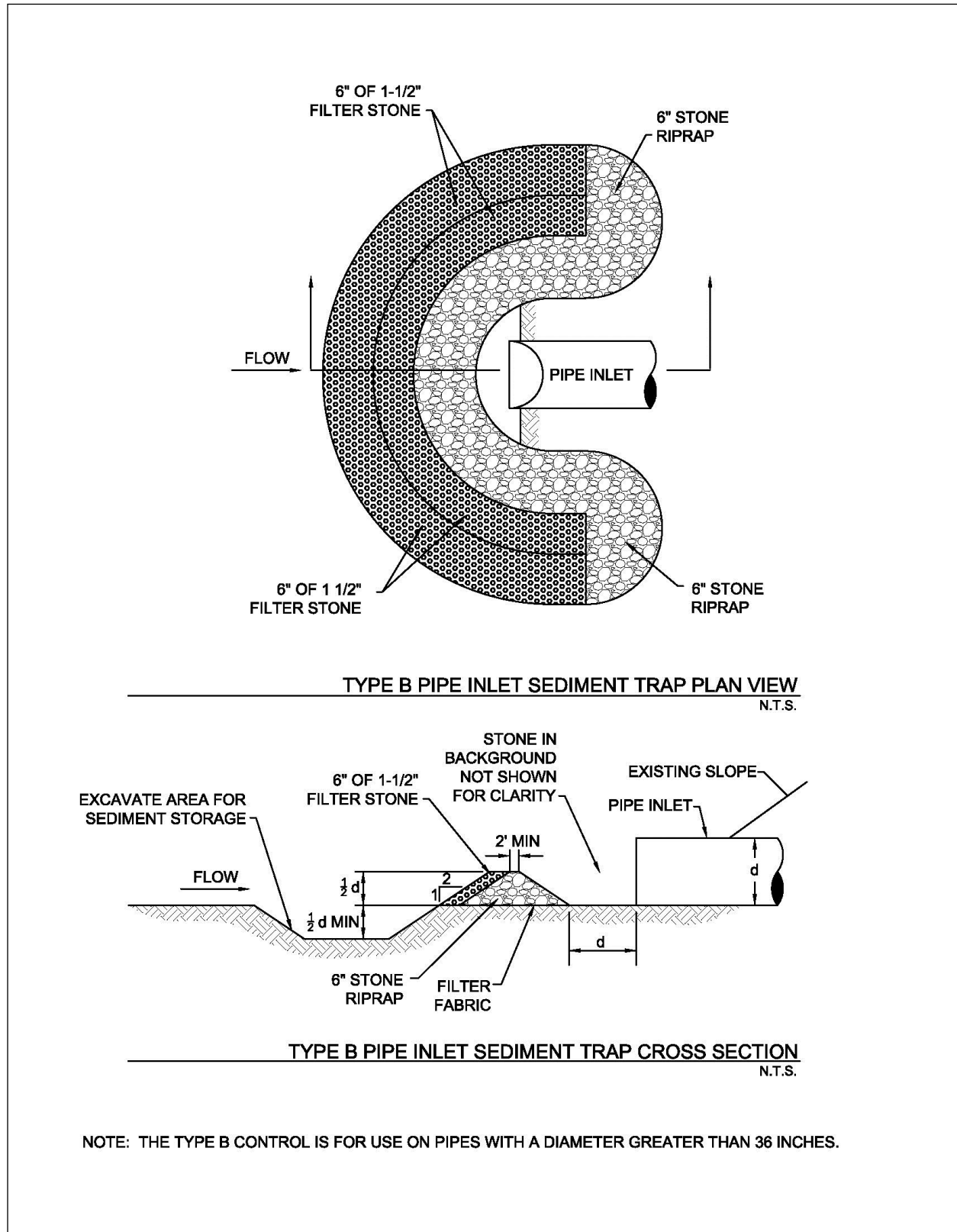
### 3.8.6 *Example Schematics*

The following schematics are example applications of the construction control. They are intended to assist in understanding the control's design and function.

The schematics are **not for construction**. They may serve as a starting point for creating a construction detail, but they must be site adapted by the designer. In addition, dimensions and notes appropriate for the application must be added by the designer.



**Figure 3.17 Schematics of Type A Pipe Inlet Sediment Trap**  
 (Source: Modified from City of Plano BMP SP-11)

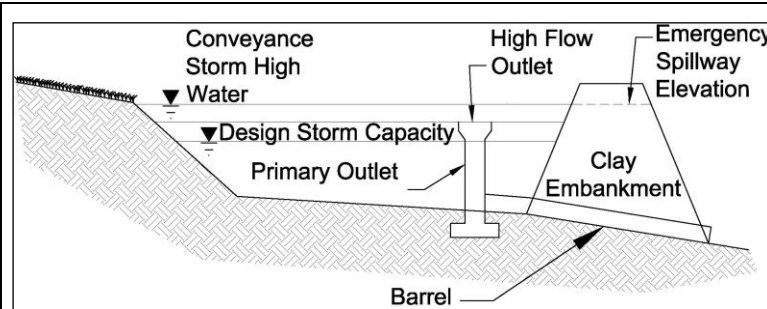


**Figure 3.18 Schematics of Type B Pipe Inlet Sediment Trap**

(Source: Modified from City of Plano BMP SP-11)

### 3.9 Sediment Basin

Sediment Control



**Description:** A sediment basin is an embankment with a controlled outlet that detains stormwater runoff, resulting in the settling of suspended sediment. The basin provides treatment for the runoff as well as detention and controlled release of runoff, decreasing erosion and flood impacts downstream.

**KEY CONSIDERATIONS**

**DESIGN CRITERIA:**

- Minimum 4:1 length to width ratio
- Maximum embankment height and storage capacity limited by TCEQ requirements
- Minimum dewatering time of 36 hours
- Safely pass 25-year, 24-hour storm event without structure damage

**ADVANTAGES / BENEFITS:**

- Effective at removing suspended sand and loam
- May be both a temporary and permanent control
- Can be used in combination with passive treatment

**DISADVANTAGES / LIMITATIONS:**

- Effectiveness depends on type of outlet
- Limited effectiveness in removing fine silt and clay
- May require a relatively large portion of the site
- Storm events that exceed the design storm event may damage the structure and cause downstream impacts

**MAINTENANCE REQUIREMENTS:**

- Inspect regularly
- Remove obstructions from discharge structures
- Remove sediment and re-grade basin when storage capacity reduced by 20 percent

**TARGETED POLLUTANTS**

- Sediment
- Nutrients & Toxic Materials
- Oil & Grease
- Floatable Materials
- Other Construction Wastes

**APPLICATIONS**

- Perimeter Control
- Slope Protection
- Sediment Barrier
- Channel Protection
- Temporary Stabilization
- Final Stabilization
- Waste Management
- Housekeeping Practices

**Fe=0.50-0.90**

*(Depends on soil type)*

**IMPLEMENTATION CONSIDERATIONS**

- Capital Costs
- Maintenance
- Training
- Suitability for Slopes > 5%

**Other Considerations:**

- *Public safety*
- *Mosquito breeding habitat*
- *Requires comprehensive planning and design*

### 3.9.1 Primary Use

Sediment basins should be used for all sites with adequate open space for a basin and where the site topography directs a majority of the site drainage to one point. Sediment basins are necessary as either temporary or permanent controls for sites with disturbed areas of 10 acres and larger that are part of a common drainage area unless specific site conditions limit their use.

### 3.9.2 Applications

Sediment basins serve as treatment devices that can be used on a variety of project types. They are normally used in site development projects in which large areas of land are available for the basin, a minor stream or off-line drainage way crosses the site, or a specific water feature is planned for the site. Sediment basins are highly effective at reducing sediment and other pollutants for design storm conditions. Sediment basins are typically easier to maintain than other structural controls (e.g. silt fences, etc).

A sediment basin by itself does not typically remove a sufficient percentage of fine silts and clays to be an effective sediment barrier. Table 3.3 provides a summary of sediment basin effectiveness based on soil type.

<b>Soil Type</b>	<b>Runoff Potential</b>	<b>Settling Rate</b>	<b>Sediment Basin Effectiveness</b>	<b>Efficiency Rating (Fe)</b>
Sand	Low	High	High	0.90
Sandy Loam	Low	High	High	0.90
Sandy Silt Loam	Moderate	Moderate	Moderate	0.75
Silt Loam	Moderate	Moderate	Moderate	0.75
Silty Clay Loam	Moderate	Low	Low	0.75
Clay Loam	Great	Low	Low	0.50
Clay	Great	Low	Low	0.50

(Source: Michigan Department of Environmental Quality Soil Erosion and Sedimentation Control Training Manual)

When the disturbed area contains a high percentage of fine silt or clay soil types, the sediment basin may be used with a passive or active treatment system to remove these finer suspended solids. Design criteria may be found in [Section 3.1 Active Treatment System](#) and [Section 3.7 Passive Treatment System](#).

### 3.9.3 Design Criteria

Texas Administrative Code Title 30, Chapter 299 (30 TAC 299), Dams and Reservoirs, contains specific requirements for dams that:

- Have a height greater than or equal to 25 feet and a maximum storage capacity greater than or equal to 15 acre-feet; or
- Have a height greater than six feet and a maximum storage capacity greater than or equal to 50 acre feet.

If the size of the detention basin meets or exceeds the above applicability, the design must be in accordance with state criteria, and the final construction plans and specifications must be submitted to the TCEQ for review and approval.

The following design criteria are for temporary sediment basins that are smaller than the TCEQ thresholds. The sediment basin shall be designed by a licensed engineer in the State of Texas. The criteria and schematics are the minimum and, in some cases, only concept level. It is the responsibility of the engineer to design and size the embankment, outfall structures, overflow spillway, and downstream

energy dissipaters and stabilization measures. Alternative designs may be acceptable if submitted to the reviewing municipality with supporting design calculations.

### Sediment Basin Location and Planning

- Design of the sediment basin should be coordinated with design of the permanent drainage infrastructure for the development.
- The basin shall not be located within a mapped 100-year floodplain unless its effects on the floodplain are modeled, and the model results are approved by the reviewing municipality.
- Basins shall not be located on a live stream that conveys stormwater from upslope property through the construction site.
- Basins may be located at the discharge point of a drainage swale that collects runoff from construction activities, or the basin may be located off-channel with a swale or dike constructed to divert runoff from disturbed areas to the basin. Design criteria for these controls are in [Section 2.2 Diversion Dike](#) and [Section 2.4 Interceptor Swale](#).
- Sediment basins must be designed, constructed, and maintained to minimize mosquito breeding habitats by minimizing the creation of standing water.
- Temporary stabilization measures should be specified for all areas disturbed to create the basin.

### Basin Size

- Minimum capacity of the basin shall be the calculated volume of runoff from a 2-year, 24-hour duration storm event plus sediment storage capacity of at least 1,000 cubic feet.
- The basin must be laid out such that the effective flow length to width ratio of the basin is a minimum of 4:1. Settling efficiencies are dependent on flow velocity, basin length, and soil type. Smaller particle sizes require slower velocities and longer basins. Basin dimensions should be designed based on flow velocities and anticipated particle sizes.
- Stoke's equation for settling velocities, as modified to Newton's equation for turbulent flow, may be used to estimate length required based on depth of the basin.

$$\text{Settling Velocity (ft/s)} = 1.74 [(\rho_p - \rho)gd/\rho]^{1/2} \quad (3.1)$$

Where:

$\rho_p$  = density of particles (lb/ ft<sup>3</sup>)

$\rho$  = density of water (lb/ft<sup>3</sup>)

$g$  = gravitational acceleration (ft/s<sup>2</sup>)

$d$  = diameter of particles (ft)

- The effective length of sediment basins may be increased with baffles. Baffles shall be spaced at a minimum distance of 100 feet. Spacing should be proportional to the flow rate, with greater spacing for higher flow rates. Check the flow velocity in the cross section created by the baffles to ensure settling will occur.
- Baffles may be constructed by using excavated soil to create a series of berms within the basin; however, porous baffles are recommended. Porous baffles may consist of coir fiber, porous geotextiles, porous turbidity barriers, and similar materials. Porous materials disrupt the flow patterns, decrease velocities, and increase sedimentation.
- Basins have limited effectiveness on suspended clay soil particles. The basin's length to width ratio typically should be 10:1 to effectively remove suspended clay particles. The use of passive treatment systems can significantly reduce this ratio and improve removal rates. Criteria are in [Section 3.7 Passive Treatment System](#).



## Embankment

- Top width shall be determined by the engineer based on the total height of the embankment as measured from the toe of the slope on the downstream side.
- Embankment side slopes shall be 3:1 or flatter.
- The embankment shall be constructed with clay soil, minimum Plasticity Index of 30 using ASTM D4318 Standard Test for Liquid Limit, Plastic Limit, and Plasticity Index of Soils.
- Clay soil for the embankment shall be placed in 8 inch lifts and compacted to 95 percent Standard Proctor Density at optimum moisture content using ASTM D698 Standard Test Methods for Laboratory Compaction Characteristics of Soil Using Standard Effort.
- The embankment should be stabilized with rock riprap or temporary vegetation.

## Outlet and Spillway

- The primary outlet shall have a minimum design dewatering time of 36 hours for the temporary control design storm (2-year, 24-hour).
- Whenever possible, the outlet shall be designed to drain the basin in less than 72 hours to minimize the potential for breeding mosquitoes.
- The basin's primary outlet and spillway shall be sized to pass the difference between the conveyance storm (25-year, 24-hour) and the temporary control design storm without causing damage to the embankment and structures.
- Unless infeasible, the primary outlet structure should withdraw water from the surface of the impounded water. Outlet structures that do this include surface skimmers, solid risers (non-perforated), flashboard risers, and weirs.
- Surface skimmers use a floating orifice to discharge water from the basin. Skimmers have the advantage of being able to completely drain the detention basin. Skimmers typically result in the greatest sediment removal efficiency for a basin, because they allow for a slower discharge rate than other types of surface outlets. Due to this slower discharge rate, a high flow riser may still be needed to discharge the conveyance storm if a large enough spillway is not feasible due to site constraints.
- Discharge rates for surface skimmers are dependent on the orifice configuration in the skimmer. Use manufacturer's flow rate charts to select the skimmer based on the flow rate needed to discharge the design storm from the basin within a selected time period (i.e.  $Q = \text{Volume}/\text{time}$ ).
- Risers shall be designed using the procedures in [Section 3.9.7 Design Procedures](#).
- Weir outlets should be designed using the guidance in [Section 2.2.2 of the Hydraulics Technical Manual](#).
- Use of overflow risers and weirs result in a pool of water that should be accounted for in the design capacity of the basin. These outlet structures are good options when the temporary sediment basin will be retained as a permanent site feature upon completion of construction. If the basin is temporary and standing water is not acceptable during construction, the construction plans shall include procedures for dewatering the basin following criteria in [Section 3.3 Dewatering Controls](#).
- Flashboard risers function like an overflow riser pipe, but they contain a series of boards that allow for adjustment of the pool level. The boards may be removed for draining the basin to a lower level. However, this operation can be difficult and a safety hazard when done manually.
- A perforated riser may be used as an outlet when surface discharge is not feasible. A perforated riser has the advantage of dewatering the basin; however, it also results in the lowest sediment removal efficiency. Perforated risers provide a relatively rapid drawdown of the pool, and they discharge water from the entire water column, resulting in more suspended sediment being discharged than with a surface outlet.

- Size and spacing of the orifices on a perforated riser shall be designed to provide the minimum detention time while allowing for the drawdown of detained water.
- Gravel (1½ to 3 inches) may be placed around the perforated riser to aid sediment removal, particularly the removal of fine soil particles, and to keep trash from plugging the perforations. The gravel is most effective when the basin will be used for less than a year. When installed for longer periods of time, the gravel may become clogged with fine sediments and require cleaning while submerged.
- The outlet of the outfall pipe (barrel) shall be stabilized with riprap or other materials designed using the conveyance storm flow rate and velocity. Velocity dissipation measures shall be used to reduce outfall velocities in excess of 5 feet per second.
- The outfall pipe through the embankment shall be provided with anti-seep collars connected to the exterior of the pipe section or at a normal joint of the pipe material. The anti-seep collar material shall be compatible with the pipe material used and shall have a watertight bond to the exterior of the pipe section. The size and number of collars shall be selected by the designer in accordance with the following formula and table:

Collar Outside Dimension = X + Diameter of pipe in feet

Example: Pipe Length = 45 feet  
 Barrel Pipe Diameter = 12 inches = 1 foot  
 2 anti-seep collars

Anti-seep Collar Dimensions:

3.4 feet (from table) + 1.0 foot (Pipe dia.) = 4.4 feet

Use 2 anti-seep collars each being 4.4 feet square or 4.4 feet diameter if round.

Pipe Length	X Values - Feet			
	Number of Anti-Seep Collars			
	1	2	3	4
40	6.0	3.0		
45	6.8	3.4		
50	7.5	3.8	2.5	
55		4.2	2.8	
60		4.5	3.0	
65		4.9	3.3	
70		5.3	3.5	2.6
75		5.6	3.8	2.8
80		6.0	4.0	3.0

- Risers used to discharge high flows shall be equipped with an anti-vortex device and trash rack.
- Spillways shall be constructed in undisturbed soil material (not fill) and shall not be placed on the embankment that forms the basin.

### 3.9.4 Design Guidance and Specifications

Design guidance for temporary sediment basins is in [Section 3.9.7 Design Procedures](#). Criteria for sediment basins that will become permanent detention basins are in [Section 3.6.3 of the iSWM Criteria Manual](#). Additional design guidance for different types of outlet structures is in [Section 2.2 of the Hydraulics Technical Manual](#).

No specification for construction of this item is currently available in the Standard Specifications for Public Works Construction – North Central Texas Council of Governments.

### 3.9.5 *Inspection and Maintenance Requirements*

Sediment basins should be inspected regularly (at least as often as required by the TPDES Construction General Permit) to check for damage and to insure that obstructions are not diminishing the effectiveness of the structure. Sediment shall be removed and the basin shall be re-graded to its original dimensions when the sediment storage capacity of the impoundment has been reduced by 20 percent. The removed sediment may be stockpiled or redistributed onsite in areas that are protected by erosion and sediment controls.

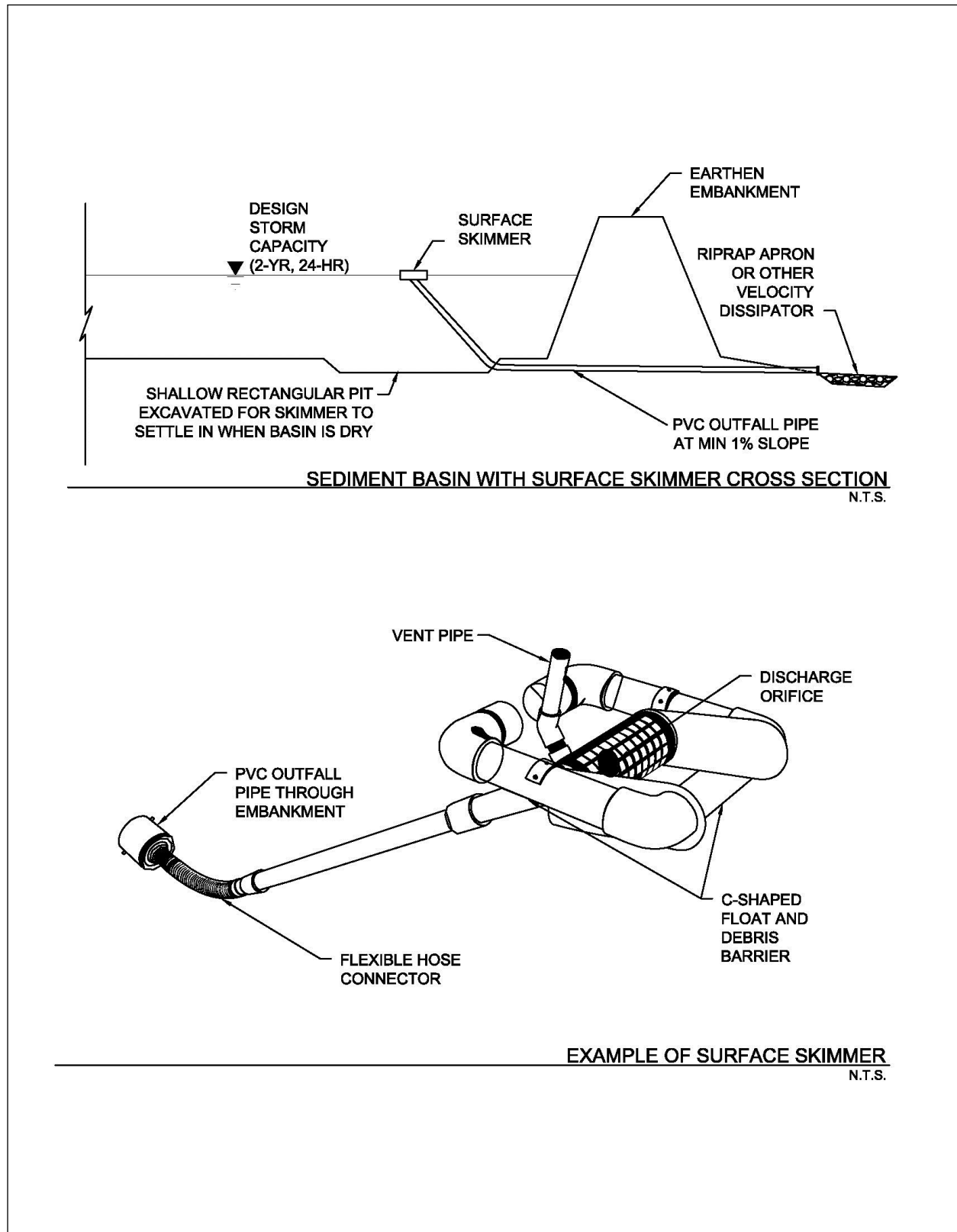
Inspect temporary stabilization of the embankment and graded basin and the velocity dissipaters at the outlet and spillway for signs of erosion. Repair any eroded areas that are found. Install additional erosion controls if erosion is frequently evident.

### 3.9.6 *Example Schematics*

The following schematics are example applications of the construction control. They are intended to assist in understanding the control's design and function.

The schematics are **not for construction**. Dimensions of the sediment basin, embankment, and appurtenances shall be designed by an engineer licensed in the State of Texas. Construction drawings submitted to the municipality for review shall include, but are not limited to, the following information and supporting calculations.

- Embankment height, side slopes and top width.
- Dimensions of the skimmer, riser, weir or other primary outlet.
- Diameter of outfall pipe (barrel).
- Pool elevation for the temporary control design storm and conveyance storm.
- Outfall pipe flow rate and velocity for the temporary control design storm and conveyance storm.
- Spillway cross section, slope, flow rate, and velocity for the conveyance storm.
- Depth, width, length, and mean stone diameter for riprap apron or other velocity dissipation device at the outfall pipe and spillway discharge points.



**Figure 3.19 Schematics of Sediment Basin with Surface Skimmer**

(Source: J.W. Faircloth & Son, Inc.)

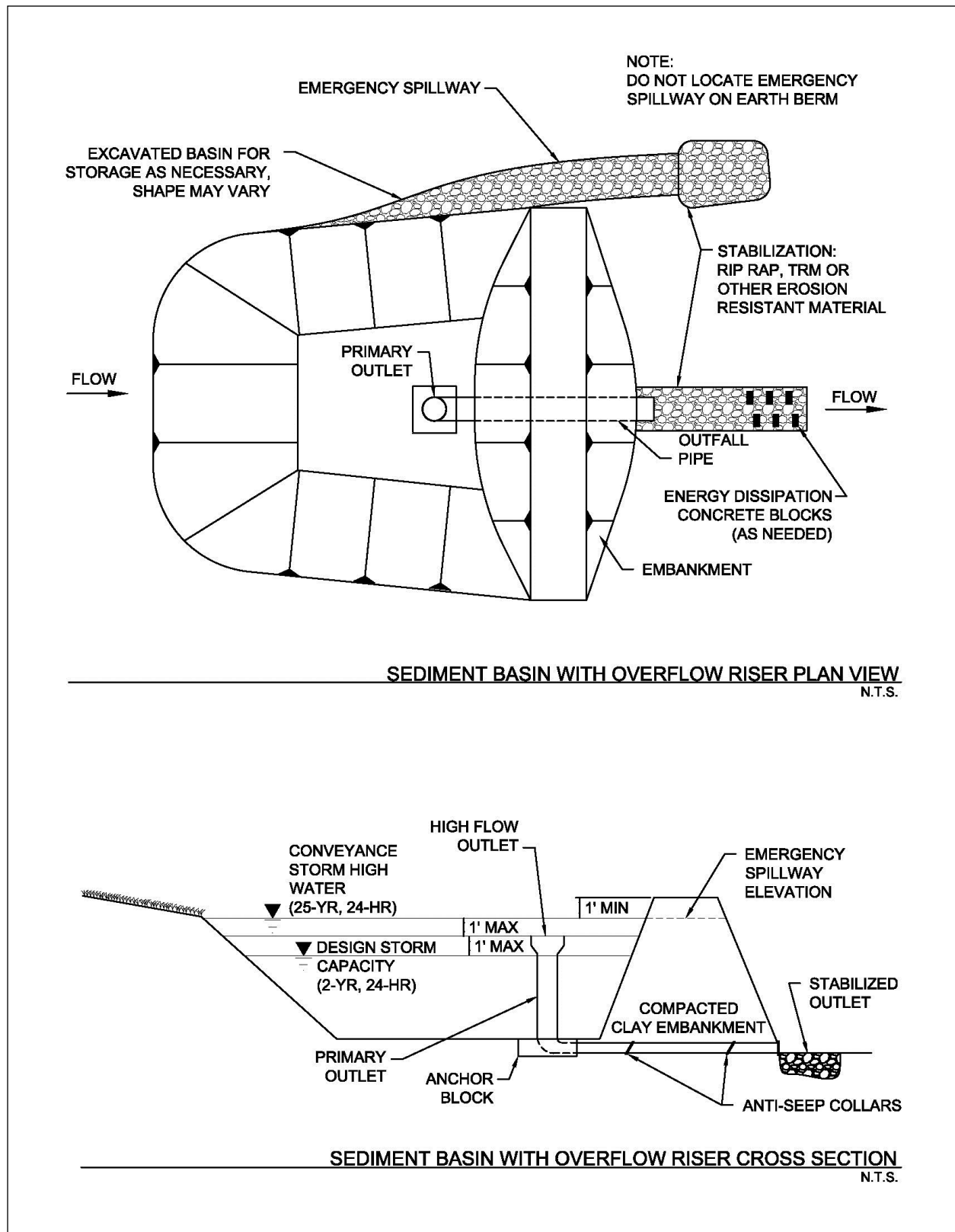
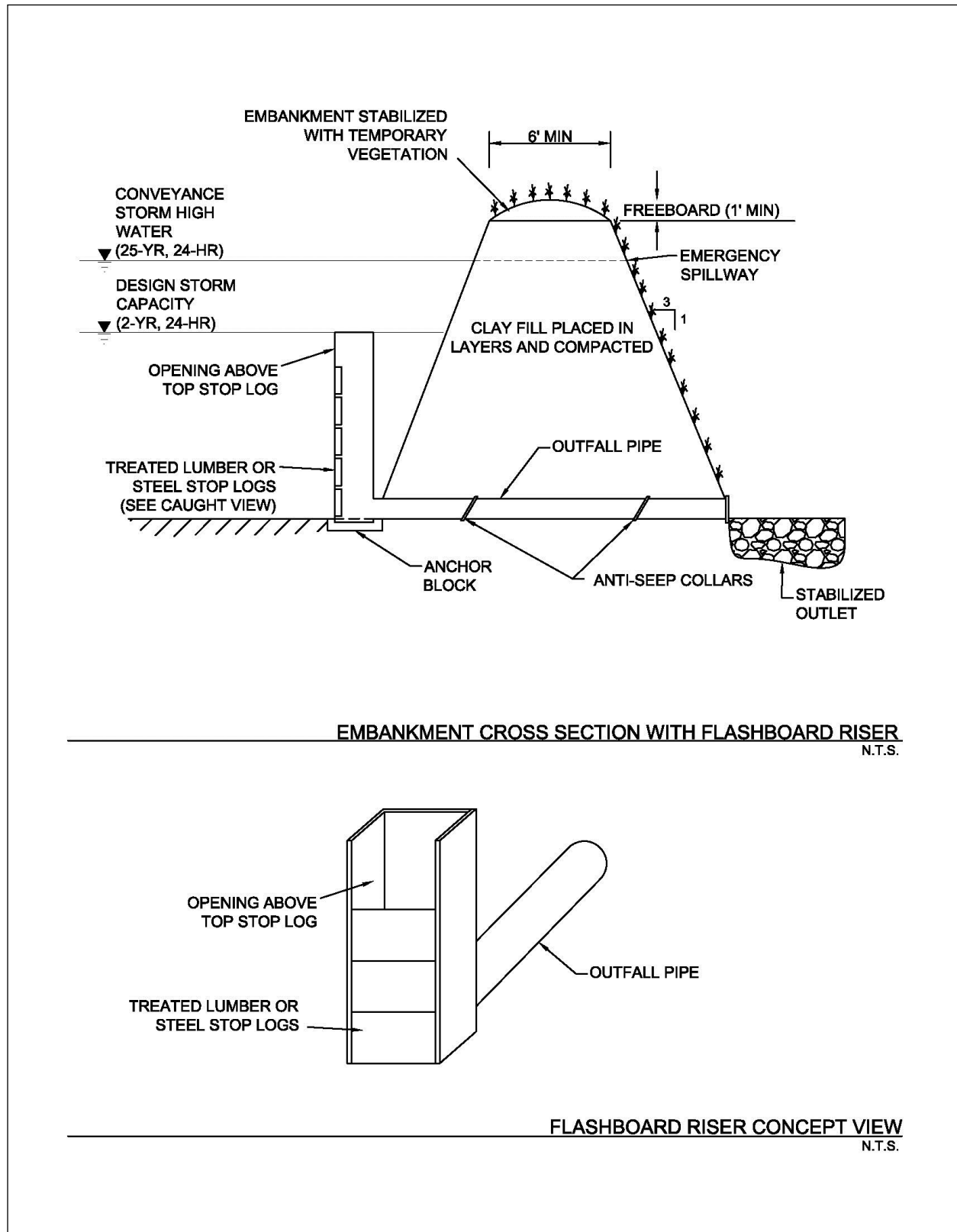


Figure 3.20 Schematics of Sediment Basin with Overflow Riser



**Figure 3.21 Schematics of Basin Embankment with Flashboard Riser**

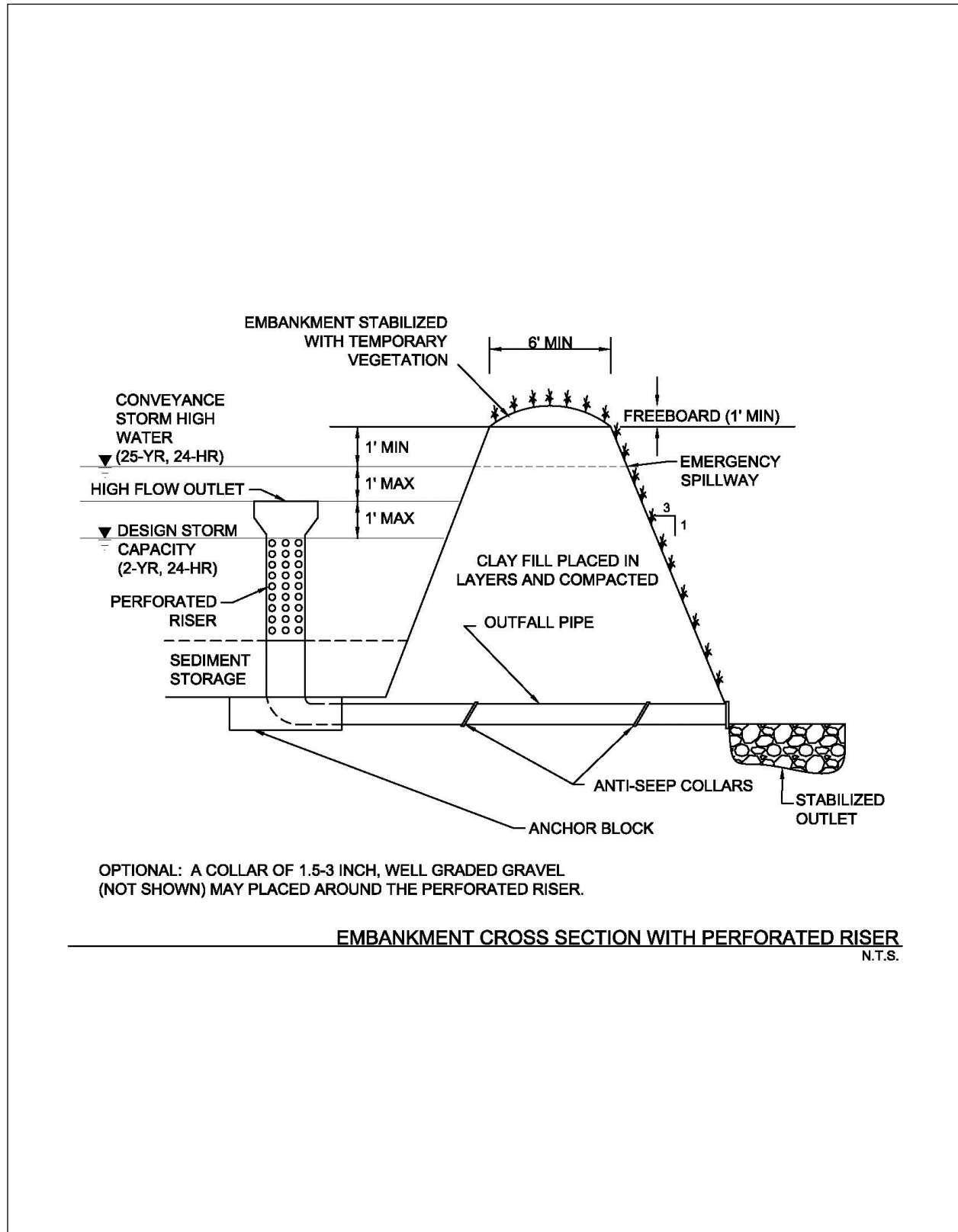


Figure 3.22 Schematic of Basin Embankment with Perforated Riser

### 3.9.7 Design Procedures

The following procedures provide a step-by-step method for the design of a temporary sediment basin that is smaller than the TCEQ thresholds for state requirements to apply. Criteria in [Section 3.8 of the iSWM Criteria Manual](#) should be used for the design of permanent basins (dry detention/extended dry detention) and stormwater ponds. [Section 3.9.8 Design Form](#) should be used to document the design values calculated for the temporary sediment basin.

These design procedures are provided as an example of the steps required to design a temporary sediment basin and are based on a specific type of primary outlet. When designing a sediment basin for a construction site, it's the engineer's responsibility to select the type of outlet that is appropriate based on criteria in the preceding sections and to modify the following procedures as needed to use appropriate calculations for the selected outlet, particularly in Steps 12, 13, and 14.

Step 1 Determine the required basin volume.

The basin volume shall be the calculated volume of runoff from the temporary control design storm (2-year, 24-hour) from each disturbed acre draining to the basin. When rainfall data is not available, a design volume of 3600 cubic feet of storage per acre drained may be used.

For a natural basin, the storage volume may be approximated as follows:

$$V_1 = 0.4 \times A_1 \times D_1 \quad (3.2)$$

where:

$V_1$  = the storage volume in cubic feet

$A_1$  = the surface area of the flooded area at the crest of the basin outlet, in square feet

$D_1$  = the maximum depth in feet, measured from the low point in the basin to the crest of the basin riser

Note 1: The volumes may be computed from more precise contour information or other suitable methods.

Note 2: Conversion between cubic feet and cubic yards is as follows:

$$\text{Number of cubic feet} \times 0.037 = \text{number of cubic yards}$$

If the volume of the basin is inadequate or embankment height becomes excessive, pursue the use of excavation to obtain the required volume.

Step 2 Determine the basin shape.

The shape of the basin must be such that the length-to-width ratio is at least 4 to 1 according to the following equation:

$$\text{Length-to-width Ratio} = \frac{L}{W_e} \quad (3.3)$$

where:

$W_e$  =  $A/L$  = the effective width

$A$  = the surface area of the normal pool

$L$  = the length of the flow path from the inflow to the outflow. If there is more than one inflow point, any inflow that carries more than 30 percent of the peak rate of inflow must meet these criteria.

The correct basin length can be obtained by proper site selection, excavation, or the use of baffles. Baffles increase the flow length by interrupting flow and directing it through the basin in a circuitous path to prevent short-circuiting. Porous baffles are recommended. Spacing of baffles should be wide enough to not cause a channeling effect within the basin. Analyze the



flow cross section and velocity between baffles to ensure that velocities are not too fast for settling to occur.

**Step 3** Design the embankment.

The side slopes of the embankment should be 3:1 or flatter.

Top width shall be determined by the engineer based on the total height of the embankment.

The area under the embankment should be cleared, grubbed, and stripped of topsoil to remove trees, vegetation, roots, or other objectionable materials. The pool area should also be cleared of all brush and trees.

The embankment fill material should be clay soil from an approved borrow area. It should be clean soil, free from roots, woody vegetation, oversized stones, and rocks.

**Step 4** Select the type(s) of outlet(s).

The outlets for the basin may consist of a combination of a primary outlet and emergency spillway or a primary outlet alone. In either case, the outlet(s) must pass the peak runoff expected from the drainage area for the conveyance storm (25-year, 24-hour) without damage to the embankment, structures, or basin.

**Step 5** Determine whether the basin will have a separate emergency spillway.

A side channel emergency spillway is required for sediment basins receiving stormwater from more than 10 acres.

**Step 6** Determine the elevation of the crest of the basin outlet riser for the required volume.

**Step 7** Estimate the elevation of the conveyance storm and the required height of the dam.

- (a) If an emergency spillway is included, the crest of the basin outlet riser must be at least 1.0 foot below the crest of the emergency spillway.
- (b) If an emergency spillway is included, the elevation of the peak flow through the emergency spillway (which will be the design high water for the conveyance storm) must be at least 1.0 foot below the top of embankment.
- (c) If an emergency spillway is not included, the crest of the basin outlet riser must be at least 3 feet below the top of the embankment.
- (d) If an emergency spillway is not included, the elevation of the design high water for the conveyance storm must be 2.0 feet below the top of the embankment.

**Step 8** Determine the peak rate of runoff for a 25-year storm.

Using SCS TR 55 Urban Hydrology for Small Watersheds or other methods, determine the peak rate of runoff expected from the drainage area of the basin for the conveyance storm. The "C" factor or "CN" value used in the runoff calculation should be derived from analysis of the contributing drainage area at the peak of land disturbance (condition which will create greatest peak runoff).

**Step 9** Design the basin outlet.

- (a) If an emergency spillway is included, the basin outfall must at least pass the peak rate of runoff from the basin drainage area for the temporary control design storm (2-year, 24-hour).

$Q_p$  = the 2-year peak rate of runoff.

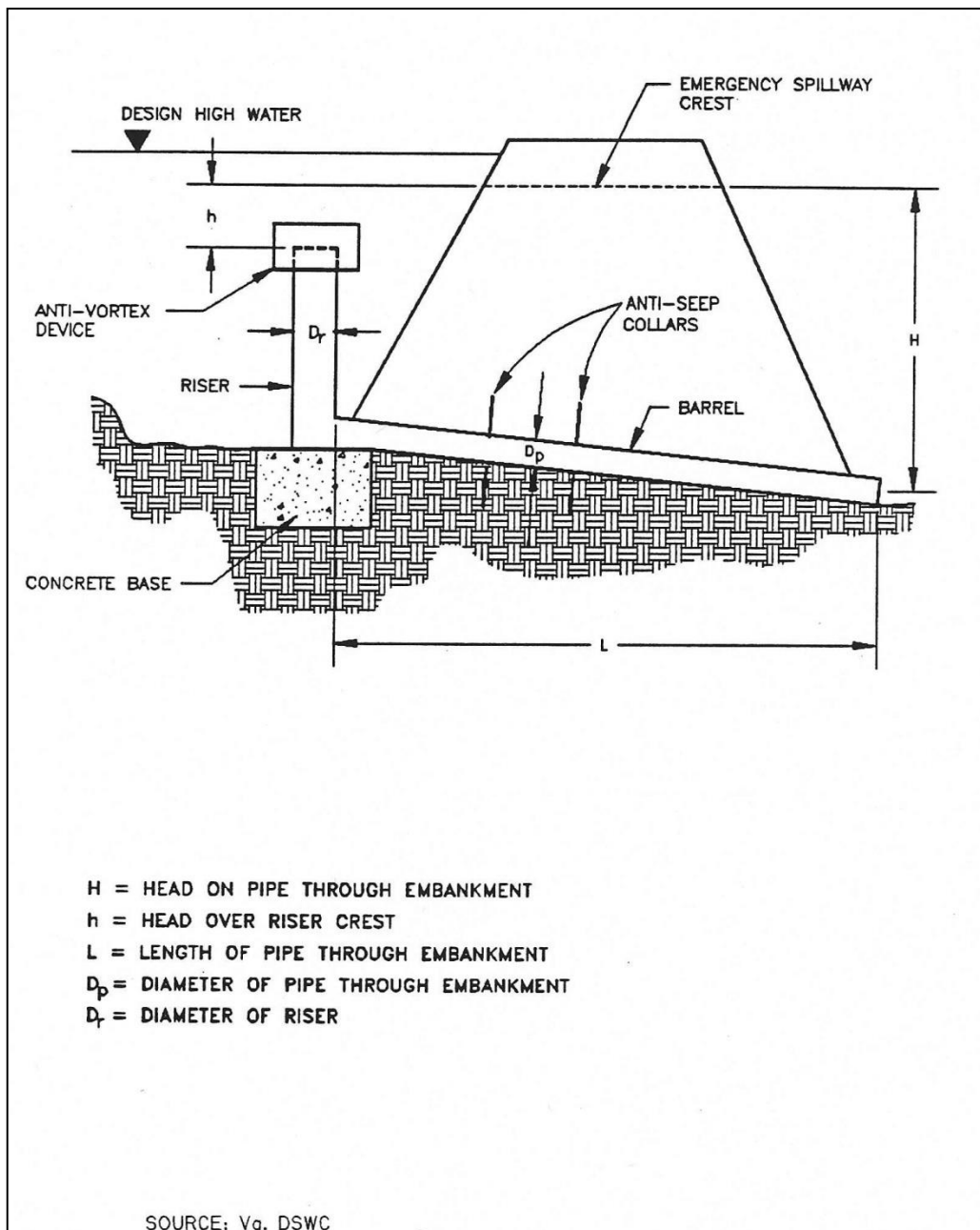
- (b) If an emergency spillway is not included, the basin outfall must pass the peak rate of runoff from the basin drainage area for the conveyance storm (25-year, 24-hour).

$Q_{25}$  = the 25-year peak rate of runoff.

- (c) Refer to Figure 3.23, where  $h$  is the difference between the elevation of the crest of the basin outlet riser and the elevation of the crest of the emergency spillway.
- (d) Enter Figure 3.24 with  $Q_p$ . Choose the smallest riser which will pass the required flow with the available head,  $h$ .
- (e) Refer to Figure 3.23, where  $H$  is the difference in elevation of the centerline of the outlet of the outfall and the crest of the emergency spillway.  $L$  is the length of the barrel through the embankment.
- (f) Enter Table 3.5 or Table 3.6 with  $H$ . Choose the smallest size outlet that will pass the flow provided by the riser. If  $L$  is other than 70 feet, make the necessary correction.
- (g) The basin riser shall consist of a solid (non-perforated), vertical pipe or box of corrugated metal joined by a watertight connection to a horizontal pipe (outfall) extending through the embankment and discharging beyond the downstream toe of the fill. Another approach is to utilize a perforated vertical riser section surrounded by filter stone.
- (h) The basin outfall, which extends through the embankment, shall be designed to carry the flow provided by the riser with the water level at the crest of the emergency spillway. The connection between the riser and the outfall must be watertight. The outlet of the outfall must be protected to prevent erosion or scour of downstream areas.
- (i) Weirs, skimmers and other types of outlets may be used if accompanied with appropriate calculations.

Step 10 Design the emergency spillway.

- (a) The emergency spillway must pass the remainder of the 25-year peak rate of runoff not carried by the basin outlet.
- (b) Compute:  $Q_e = Q_{25} - Q_p$
- (c) Refer to Figure 3.25 and Table 3.7.
- (d) Determine approximate permissible values for  $b$ , the bottom width;  $s$ , the slope of the exit channel; and  $X$ , minimum length of the exit channel.
- (e) Enter Table 3.7 and choose the exit channel cross-section which passes the required flow and meets the other constraints of the site.
- (f) Notes:
  - 1. The maximum permissible velocity for vegetated waterways must be considered when designing an exit channel.
  - 2. For a given  $H_p$ , a decrease in the exit slope from  $S$  as given in the table decreases spillway discharge, but increasing the exit slope from  $S$  does not increase discharge. If an exit slope ( $S_e$ ) steeper than  $S$  is used, then the exit should be considered an open channel and analyzed using the Manning's Equation.
  - 3. Data to the right of heavy vertical lines should be used with caution, as the resulting sections will be either poorly proportioned or have excessive velocities.
- (g) The emergency spillway should not be constructed over fill material.
- (h) The emergency spillway should be stabilized with rock riprap or temporary vegetation upon completion of the basin.



**Figure 3.23 Example of Basin Outlet Design**

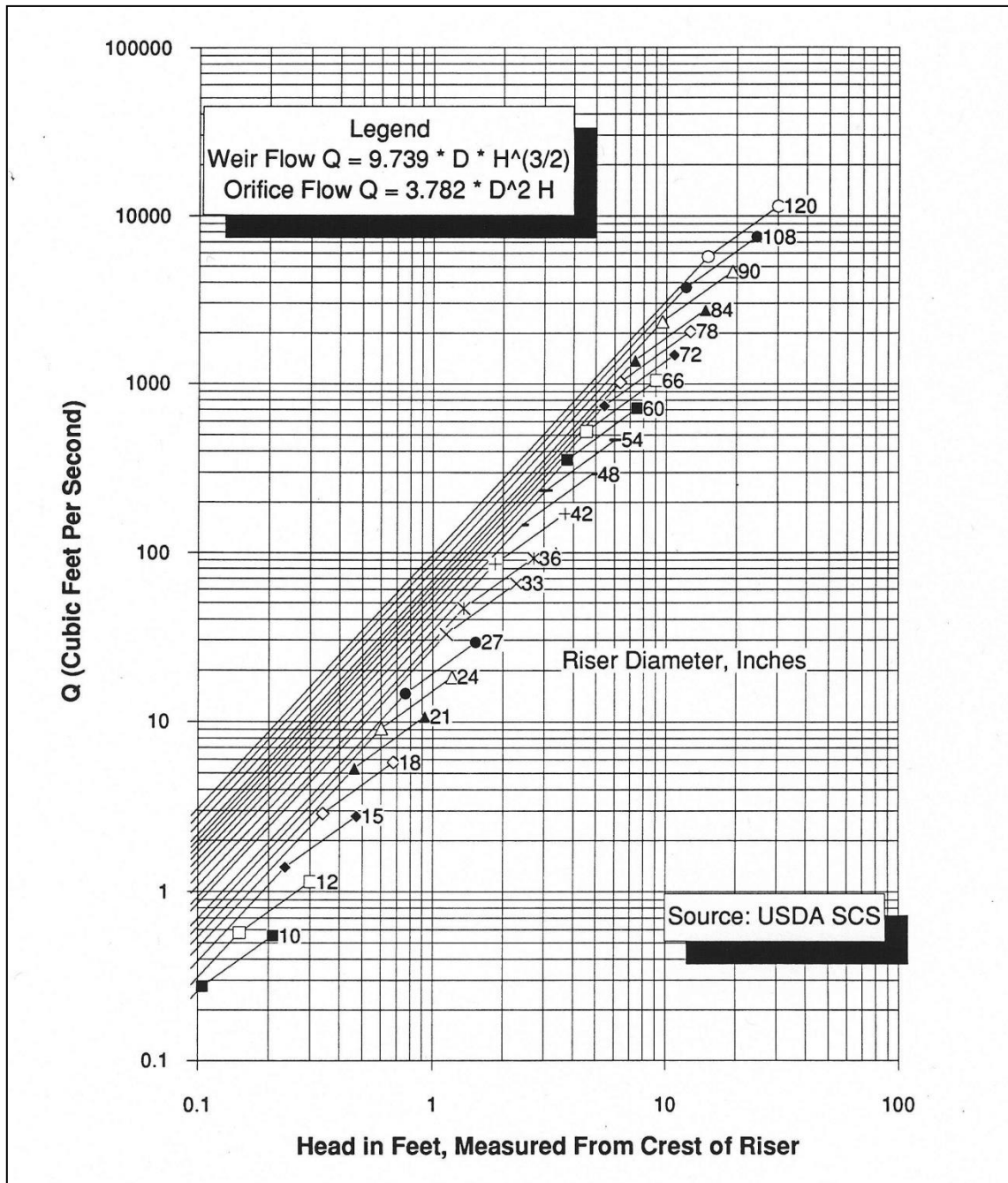


Figure 3.24 Riser Inflow Curves for Basin Outlet Design

**Table 3.5 Pipe Flow Chart, n=0.013**

For Reinforced Concrete Pipe Inlet  $K_m = K_e + K_b = 0.65$  and 70 Feet of Reinforced Concrete Pipe Conduit (Full Flow Assumed)  
Note: Correction Factors for pipe lengths other than 70 feet

Head (In feet)	Pipe Diameter in Inches																	
	12	15	18	21	24	30	36	42	48	54	60	66	72	78	84	90	96	102
1	3.22	5.44	8.29	11.8	15.9	26	38.6	53.8	71.4	91.5	114	139	167	197	229	264	302	342
2	4.55	7.69	11.7	16.7	22.5	36.8	54.6	76	101	129	161	197	236	278	324	374	427	483
3	5.57	9.42	14.4	20.4	27.5	45	66.9	93.1	124	159	198	241	289	341	397	458	523	592
4	6.43	10.9	16.6	23.5	31.8	52	77.3	108	143	183	228	278	334	394	459	529	604	683
5	7.19	12.2	18.5	26.3	35.5	58.1	86.4	120	160	205	255	311	373	440	513	591	675	764
6	7.88	13.3	20.3	28.8	38.9	63.7	94.6	132	175	224	280	341	409	482	562	647	739	837
7	8.51	14.4	21.9	31.1	42	68.8	102	142	189	242	302	368	441	521	607	699	798	904
8	9.1	15.4	23.5	33.3	44.9	73.5	109	152	202	259	323	394	472	557	648	748	854	966
9	9.65	16.3	24.9	35.3	47.7	78	116	161	214	275	342	418	500	590	688	793	905	1025
10	10.2	17.2	26.2	37.2	50.2	82.2	122	170	226	289	361	440	527	622	725	836	954	1080
11	10.7	18	27.5	39	52.7	86.2	128	178	237	304	379	462	553	653	761	877	1001	1133
12	11.1	18.9	28.7	40.8	55	90.1	134	186	247	317	395	482	578	682	794	916	1045	1184
13	11.6	19.6	29.9	42.4	57.3	93.7	139	194	257	330	411	502	601	710	827	953	1088	1232
14	12	20.4	31	44.1	59.4	97.3	145	201	267	342	427	521	624	736	858	989	1129	1278
15	12.5	21.1	32.1	45.6	61.5	101	150	208	277	354	442	539	646	762	888	1024	1169	1323
16	12.9	21.8	33.2	47.1	63.5	104	155	215	286	366	457	557	667	787	917	1057	1207	1367
17	13.3	22.4	34.2	48.5	65.5	107	159	222	294	377	471	574	688	812	946	1090	1244	1409
18	13.7	23.1	35.2	49.9	67.4	110	164	228	303	388	484	591	708	835	973	1121	1280	1450
19	14	23.7	36.1	51.3	69.2	113	168	234	311	399	497	607	727	858	1000	1152	1315	1489
20	14.4	24.3	37.1	52.6	71	116	173	240	319	409	510	623	746	880	1026	1182	1350	1528
21	14.7	24.9	38	53.9	72.8	119	177	246	327	419	523	638	764	902	1051	1211	1383	1566
22	15.1	25.5	38.9	55.2	74.5	122	181	252	335	429	535	653	782	923	1076	1240	1415	1603
23	15.4	26.1	39.8	56.5	76.2	125	186	258	342	439	547	668	800	944	1100	1268	1447	1639
24	15.8	26.7	40.6	57.7	77.8	127	189	263	350	448	559	682	817	964	1123	1295	1478	1674
25	16.1	27.2	41.5	58.9	79.4	130	193	269	357	458	571	696	834	984	1147	1322	1509	1708
26	16.4	27.7	42.3	60	81	133	197	274	364	467	582	710	850	1004	1169	1348	1539	1742
27	16.7	28.3	43.1	61.2	82.5	135	201	279	371	476	593	723	867	1023	1192	1373	1568	1775
28	17	28.8	43.9	62.3	84.1	138	204	285	378	484	604	737	883	1041	1214	1399	1597	1808
29	17.3	29.3	44.7	63.4	85.5	140	208	290	384	493	615	750	898	1060	1235	1423	1625	1840
30	17.6	29.8	45.4	64.5	87	142	212	294	391	501	625	763	913	1078	1256	1448	1653	1871
Correction Factors for Other Pipe Lengths																		
20	1.3	1.24	1.21	1.18	1.15	1.12	1.1	1.08	1.07	1.06	1.05	1.05	1.04	1.04	1.03	1.03	1.03	1.03
30	1.22	1.18	1.15	1.13	1.12	1.09	1.08	1.06	1.05	1.05	1.04	1.04	1.04	1.03	1.03	1.02	1.02	1.02
40	1.15	1.13	1.11	1.1	1.08	1.07	1.05	1.05	1.04	1.03	1.03	1.03	1.02	1.02	1.02	1.02	1.02	1.02
50	1.09	1.08	1.07	1.06	1.05	1.04	1.04	1.03	1.03	1.02	1.02	1.02	1.02	1.01	1.01	1.01	1.01	1.01
60	1.04	1.04	1.03	1.03	1.03	1.02	1.02	1.02	1.01	1.01	1.01	1.01	1.01	1.01	1.01	1.01	1.01	1.01
70	1	1	1	1	1	1	1	1	1	1	1	1	1	1	1	1	1	1
80	0.96	0.97	0.97	0.97	0.98	0.98	0.98	0.99	0.99	0.99	0.99	0.99	0.99	0.99	0.99	0.99	0.99	0.99
90	0.93	0.94	0.94	0.95	0.95	0.96	0.97	0.97	0.98	0.98	0.98	0.98	0.98	0.98	0.99	0.99	0.99	0.99
100	0.9	0.91	0.92	0.93	0.93	0.95	0.95	0.96	0.96	0.97	0.97	0.98	0.98	0.98	0.98	0.98	0.98	0.98
120	0.84	0.86	0.87	0.89	0.9	0.91	0.93	0.94	0.94	0.95	0.96	0.96	0.96	0.97	0.97	0.97	0.97	0.98
140	0.8	0.82	0.83	0.85	0.86	0.88	0.9	0.91	0.92	0.93	0.94	0.94	0.95	0.95	0.96	0.96	0.96	0.97
160	0.76	0.78	0.8	0.82	0.83	0.86	0.88	0.89	0.9	0.91	0.92	0.93	0.94	0.94	0.95	0.95	0.95	0.96

Source: USDA SCS



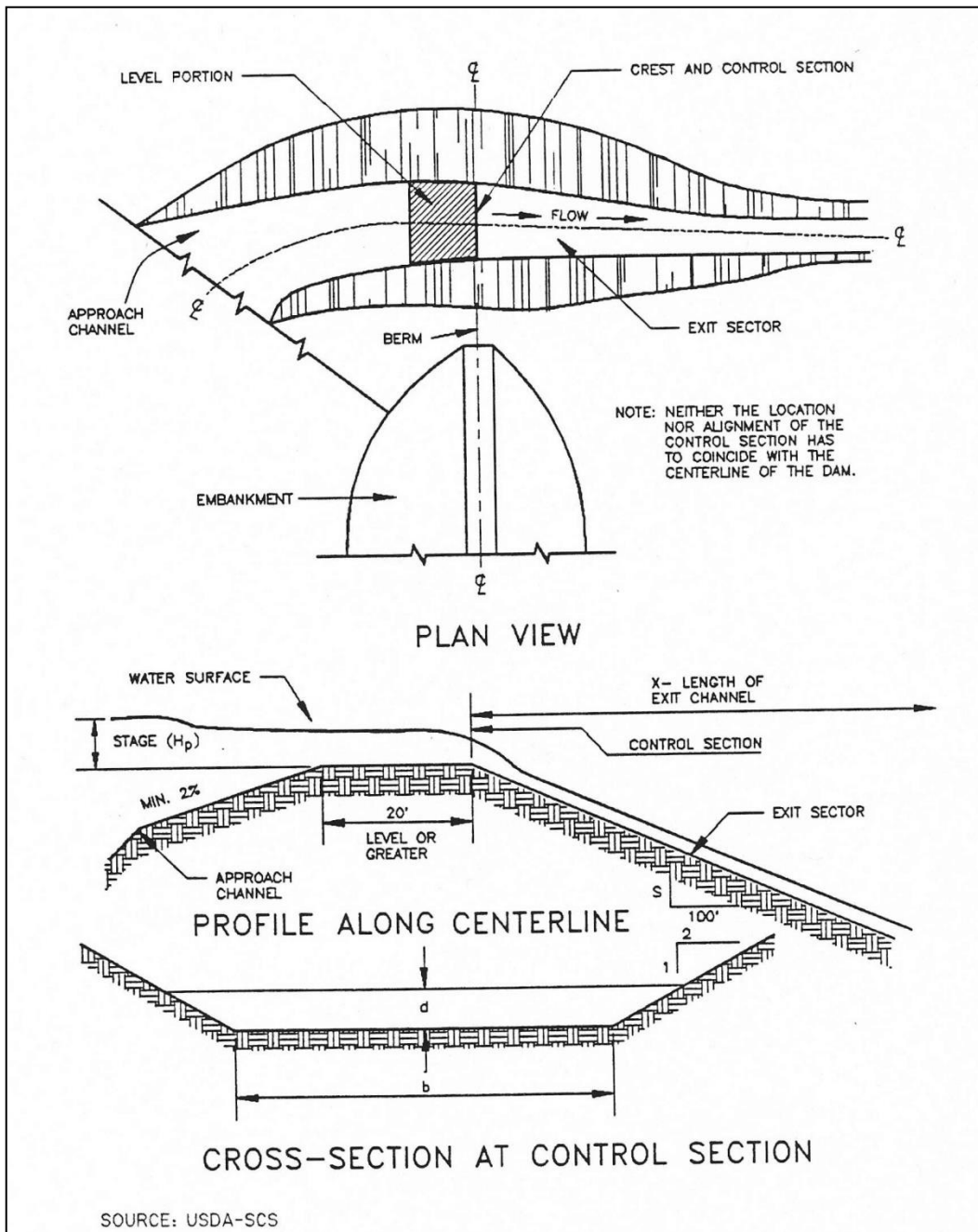


Figure 3.25 Example of Excavated Earth Spillway Design

Table 3.7 Design Data for Earth Spillways

Stage (Hp) In Feet	Spillway Variables	Bottom Width (b) in Feet																
		8	10	12	14	16	18	20	22	24	26	28	30	32	34	36	38	40
0.5	Q	6	7	8	10	11	13	14	15	17	18	20	21	22	24	25	27	28
	V	2.7	2.7	2.7	2.7	2.7	2.7	2.7	2.7	2.7	2.7	2.7	2.7	2.7	2.7	2.7	2.7	2.7
	S	3.9	3.9	3.9	3.9	3.8	3.8	3.8	3.8	3.8	3.8	3.8	3.8	3.8	3.8	3.8	3.8	3.8
	X	32	33	33	33	33	33	33	33	33	33	33	33	33	33	33	33	33
0.6	Q	8	10	12	14	16	18	20	22	24	26	28	30	32	34	35	37	39
	V	3	3	3	3	3	3	3	3	3	3	3	3	3	3	3	3	3
	S	3.7	3.7	3.7	3.7	3.6	3.7	3.6	3.6	3.6	3.6	3.6	3.6	3.6	3.6	3.6	3.6	3.6
	X	36	36	36	36	36	36	37	37	37	37	37	37	37	37	37	37	37
0.7	Q	11	13	16	18	20	23	25	28	30	33	35	38	41	43	44	46	48
	V	3.2	3.2	3.3	3.3	3.3	3.3	3.3	3.3	3.3	3.3	3.3	3.3	3.3	3.3	3.3	3.3	3.3
	S	3.5	3.5	3.4	3.4	3.4	3.4	3.4	3.4	3.4	3.4	3.4	3.4	3.4	3.4	3.4	3.4	3.4
	X	39	40	40	40	41	41	41	41	41	41	41	41	41	41	41	41	41
0.8	Q	13	16	19	22	26	29	32	35	38	42	45	46	48	51	54	57	60
	V	3.5	3.5	3.5	3.6	3.6	3.6	3.6	3.6	3.6	3.6	3.6	3.6	3.6	3.6	3.6	3.6	3.6
	S	3.3	3.3	3.3	3.2	3.2	3.2	3.2	3.2	3.2	3.2	3.2	3.2	3.2	3.2	3.2	3.2	3.2
	X	44	44	44	44	44	45	45	45	45	45	45	45	45	45	45	45	45
0.9	Q	17	20	24	28	32	35	39	43	47	51	53	57	60	64	68	71	75
	V	3.7	3.8	3.8	3.8	3.8	3.8	3.8	3.8	3.8	3.8	3.8	3.8	3.8	3.8	3.8	3.8	3.8
	S	3.2	3.1	3.1	3.1	3.1	3.1	3.1	3.1	3.1	3.1	3.1	3.1	3.1	3.1	3.1	3.1	3.1
	X	47	47	48	48	48	48	48	48	48	48	49	49	49	49	49	49	49
1	Q	20	24	29	33	38	42	47	51	56	61	63	68	72	77	81	86	90
	V	4	4	4	4	4	4	4	4	4	4	4	4	4	4	4	4	4
	S	3.1	3	3	3	3	3	3	3	3	3	3	3	3	3	3	3	3
	X	51	51	51	51	52	52	52	52	52	52	52	52	52	52	52	52	52
1.1	Q	23	28	34	39	44	49	54	60	65	70	74	79	84	89	95	100	105
	V	4.2	4.2	4.2	4.3	4.3	4.3	4.3	4.3	4.3	4.3	4.3	4.3	4.3	4.3	4.3	4.3	4.3
	S	2.9	2.9	2.9	2.9	2.9	2.9	2.9	2.9	2.9	2.8	2.8	2.8	2.8	2.8	2.8	2.8	2.8
	X	55	55	55	55	55	55	55	56	56	56	56	56	56	56	56	56	56
1.2	Q	28	33	40	45	51	58	64	69	76	80	86	92	98	104	110	116	122
	V	4.4	4.4	4.4	4.4	4.4	4.5	4.5	4.5	4.5	4.5	4.5	4.5	4.5	4.5	4.5	4.5	4.5
	S	2.9	2.9	2.8	2.8	2.8	2.8	2.8	2.8	2.8	2.8	2.8	2.8	2.8	2.8	2.8	2.8	2.8
	X	58	58	59	59	59	59	59	59	60	60	60	60	60	60	60	60	60
1.3	Q	32	38	46	53	58	65	73	80	86	91	99	106	112	119	125	133	140
	V	4.5	4.6	4.6	4.6	4.6	4.6	4.7	4.7	4.7	4.7	4.7	4.7	4.7	4.7	4.7	4.7	4.7
	S	2.8	2.8	2.8	2.7	2.7	2.7	2.7	2.7	2.7	2.7	2.7	2.7	2.7	2.7	2.7	2.7	2.7
	X	62	62	62	63	63	63	63	63	63	63	63	64	64	64	64	64	64
1.4	Q	37	44	51	59	66	74	82	90	96	103	111	119	127	134	143	150	158
	V	4.8	4.8	4.8	4.8	4.8	4.8	4.8	4.8	4.8	4.9	4.9	4.9	4.9	4.9	4.9	4.9	4.9
	S	2.8	2.7	2.7	2.7	2.7	2.7	2.7	2.6	2.6	2.6	2.6	2.6	2.6	2.6	2.6	2.6	2.6
	X	65	66	66	66	66	67	67	67	67	67	67	68	68	68	68	68	69



**Table 3.7 Design Data for Earth Spillways (continued)**

Stage (Hp) In Feet	Spillway Variables	Bottom Width (b) In Feet																
		8	10	12	14	16	18	20	22	24	26	28	30	32	34	36	38	40
1.5	Q	41	50	58	66	75	85	92	101	108	116	125	133	142	150	160	169	178
	V	4.8	4.9	5	5	5	5	5	5	5	5	5	5	5	5	5.1	5.1	5.1
	S	2.7	2.7	2.6	2.6	2.6	2.6	2.6	2.6	2.6	2.6	2.6	2.6	2.6	2.6	2.5	2.5	2.5
	X	69	69	70	70	71	71	71	71	71	71	71	71	72	72	72	72	72
1.6	Q	46	56	65	75	84	94	104	112	122	132	142	149	158	168	178	187	197
	V	5	5.1	5.1	5.1	5.1	5.2	5.2	5.2	5.2	5.2	5.2	5.2	5.2	5.2	5.2	5.2	5.2
	S	2.6	2.6	2.6	2.6	2.5	2.5	2.5	2.5	2.5	2.5	2.5	2.5	2.5	2.5	2.5	2.5	2.5
	X	72	74	74	75	75	76	76	76	76	76	76	76	76	76	76	76	76
1.7	Q	52	62	72	83	94	105	115	126	135	145	156	167	175	187	196	206	217
	V	5.2	5.2	5.2	5.3	5.3	5.3	5.3	5.4	5.4	5.4	5.4	5.4	5.4	5.4	5.4	5.4	5.4
	S	2.6	2.6	2.5	2.5	2.5	2.5	2.5	2.5	2.5	2.5	2.5	2.5	2.5	2.5	2.5	2.5	2.5
	X	76	78	79	80	80	80	80	80	80	80	80	80	80	80	80	80	80
1.8	Q	58	69	81	93	104	116	127	138	150	160	171	182	194	204	214	226	233
	V	5.3	5.4	5.4	5.5	5.5	5.5	5.5	5.5	5.5	5.5	5.5	5.6	5.6	5.6	5.6	5.6	5.6
	S	2.5	2.5	2.5	2.5	2.4	2.4	2.4	2.4	2.4	2.4	2.4	2.4	2.4	2.4	2.4	2.4	2.4
	X	80	82	83	84	84	84	84	84	84	84	84	84	84	84	84	84	84
1.9	Q	64	76	88	102	114	127	140	152	164	175	188	201	213	225	235	248	260
	V	5.5	5.5	5.5	5.6	5.6	5.6	5.7	5.7	5.7	5.7	5.7	5.7	5.7	5.7	5.7	5.7	5.7
	S	2.5	2.5	2.5	2.4	2.4	2.4	2.4	2.4	2.4	2.4	2.4	2.4	2.4	2.4	2.4	2.4	2.4
	X	84	85	86	87	88	88	88	88	88	88	88	88	88	88	88	88	88
2	Q	71	83	97	111	125	138	153	164	178	193	204	218	232	245	256	269	283
	V	5.6	5.7	5.7	5.7	5.8	5.8	5.8	5.8	5.8	5.8	5.8	5.9	5.9	5.9	5.9	5.9	5.9
	S	2.5	2.4	2.4	2.4	2.4	2.4	2.4	2.4	2.3	2.3	2.3	2.3	2.3	2.3	2.3	2.3	2.3
	X	88	90	91	91	91	91	92	92	92	92	92	92	92	92	92	92	92
2.1	Q	77	91	107	122	135	149	162	177	192	207	220	234	250	267	276	291	305
	V	5.7	5.8	5.9	5.9	5.9	5.9	5.9	6	6	6	6	6	6	6	6	6	6
	S	2.4	2.4	2.4	2.4	2.4	2.3	2.3	2.3	2.3	2.3	2.3	2.3	2.3	2.3	2.3	2.3	2.3
	X	92	93	95	95	95	95	95	95	95	96	96	96	96	96	96	96	96
2.2	Q	84	100	116	131	146	163	177	194	210	224	238	253	269	288	301	314	330
	V	5.9	5.9	6	6	6	6.1	6.1	6.1	6.1	6.1	6.1	6.1	6.1	6.2	6.2	6.2	6.2
	S	2.4	2.4	2.4	2.3	2.3	2.3	2.3	2.3	2.3	2.3	2.3	2.3	2.3	2.3	2.3	2.3	2.3
	X	96	98	99	99	99	99	99	100	100	100	100	100	100	100	100	100	100
2.3	Q	90	108	124	140	158	175	193	208	226	243	258	275	292	306	323	341	354
	V	6	6.1	6.1	6.1	6.2	6.2	6.2	6.2	6.3	6.3	6.3	6.3	6.3	6.3	6.3	6.3	6.3
	S	2.4	2.4	2.3	2.3	2.3	2.3	2.3	2.3	2.2	2.2	2.2	2.2	2.2	2.2	2.2	2.2	2.2
	X	100	102	102	103	103	103	104	104	104	105	105	105	105	105	105	105	105
2.4	Q	99	116	136	152	170	189	206	224	241	260	275	294	312	327	346	364	378
	V	6.1	6.2	6.2	6.3	6.3	6.3	6.4	6.4	6.4	6.4	6.4	6.4	6.4	6.4	6.4	6.4	6.4
	S	2.3	2.3	2.3	2.3	2.3	2.2	2.2	2.2	2.2	2.2	2.2	2.2	2.2	2.2	2.2	2.2	2.2
	X	105	105	106	107	107	108	108	108	108	109	109	109	109	109	109	109	109

**Source: USDA - SCS**

Step 11 Re-estimate the elevation of the design high water and the top of the dam based upon the design of the basin outlet and the emergency spillway.

Step 12 Design the anti-vortex device and trash rack.

If an outfall riser is used, an anti-vortex device and trash rack shall be attached to the top of the basin riser to improve the flow of water into the outfall and prevent floating debris from being carried out of the basin.

This design procedure for the anti-vortex device and trash rack refers only to round riser pipes of corrugated metal. There are numerous ways to provide protection for concrete pipe; these include various hoods and grates and rebar configurations which should be a part of project-specific design and will frequently be a part of a permanent structure.

Refer to Figure 3.26 and Table 3.8. Choose cylinder size, support bars, and top requirements from Table 3.8 based on the diameter of the riser pipe.

Step 13 Design the anchoring for the basin outlet.

The basin outlet must be firmly anchored to prevent its floating.

If the riser is over 10 feet high, the forces acting on the spillway must be calculated. A method of anchoring the spillway which provides a safety factor of 1.25 must be used (downward forces = 1.25 x upward forces).

If the riser is 10 feet or less in height, choose one of the two methods in Figure 3.27 to anchor the basin outlet.

Determine the number and spacing of anti-seep collars for the outfall pipe through the embankment.

Step 14 Provide for dewatering.

(a) Use a modified version of the discharge equation for a vertical orifice and a basic equation for the area of a circular orifice.

Naming the variables:

A = flow area of orifice, in square feet

D = diameter of circular orifice, in inches

h = average driving head (maximum possible head measured from radius of orifice to crest of basin outlet divided by 2), in feet

Q = volumetric flow rate through orifice needed to achieve approximate 6-hour drawdown, cubic feet per second

S = total storage available in dry storage area, cubic feet

Q = S/21,600 seconds

(b) An alternative approach for dewatering is the use of a perforated riser (0.75" to 1" diameter holes spaced every 12 inch horizontally and 8 inch vertically) with 1½ inch to 2 inch filter stone stacked around the exterior.

Use S for basin and find Q. Then substitute in calculated Q and find A:

$$A = (0.6) \times \frac{Q}{(64.32 \times \frac{h}{2})} \quad (3.4)$$

Then, substitute in calculated A and find d:

$$d^* = 2 \times \frac{(\underline{A})}{(3.14)} \quad (3.5)$$

Diameter of the dewatering orifice should never be less than 3 inches in order to help prevent clogging by soil or debris.

Flexible tubing should be at least 2 inches larger in diameter than the calculated orifice to promote improved flow characteristics.

Additional design guidance for orifices and perforated risers are in [Section 2.2.2 of the Hydraulics Technical Manual](#).

- (c) If a surface skimmer is used as the basin's primary outlet, it may also be used to dewater the basin. Orifice flowrates for the skimmer will be provided by the manufacturer.

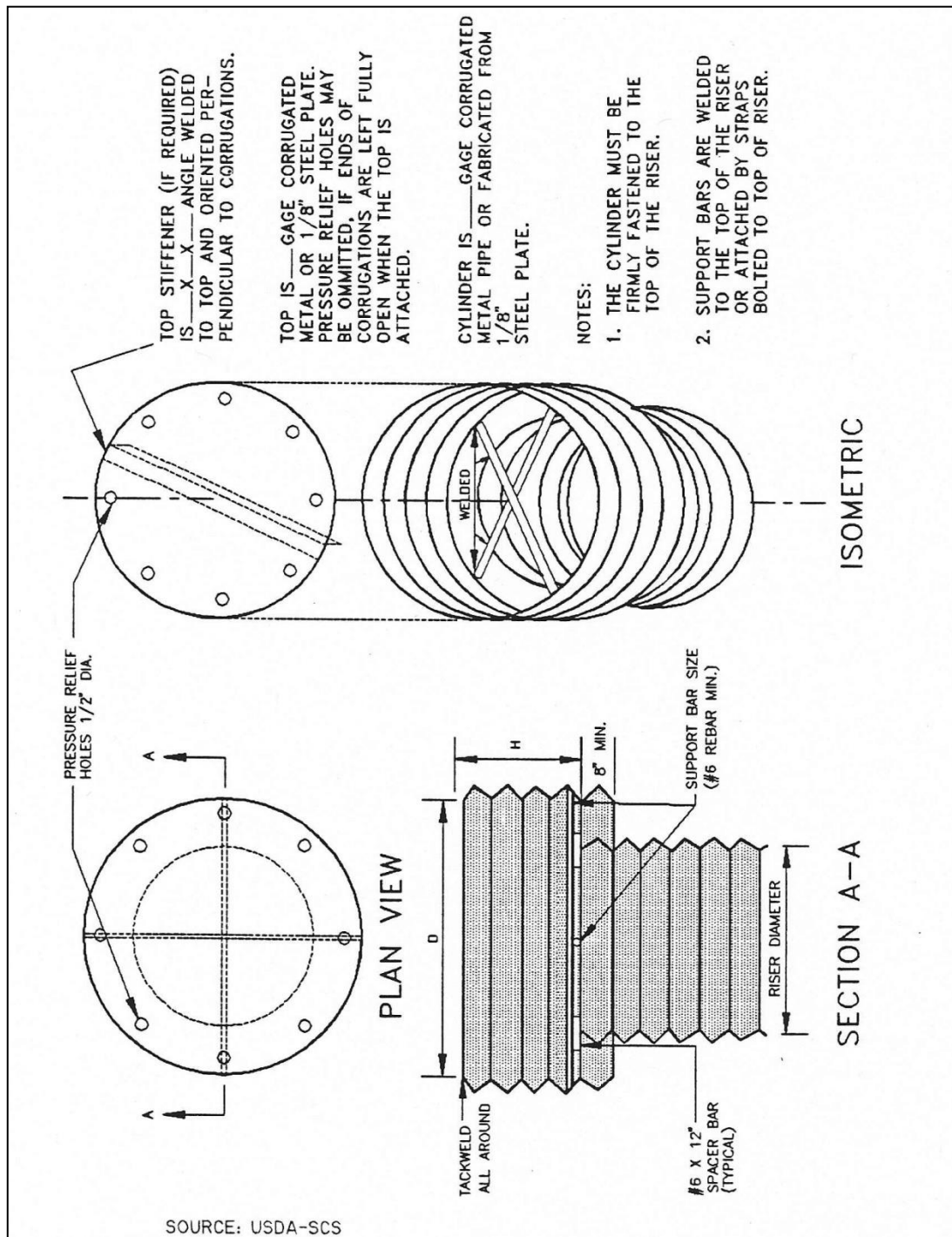


Figure 3.26 Example of Anti-Vortex Design for Corrugated Metal Pipe Riser

**Table 3.8 Trash Rack and Anti-Vortex Device Design Table**

Riser Diam., in.	Cylinder		Height inches	Minimum Size Support Bar	Minimum Top	
	Diameter inches	Thickness gage			Thickness	Stiffener
12	18	16	6	#6 Rebar or 1 ½ x 1 ½ x 3/16 angle	16 ga. (F&C)	-
15	21	16	7	" "	" "	-
18	27	16	8	" "	" "	-
21	30	16	11	" "	16 ga.(C), 14 ga.(F)	-
24	36	16	13	" "	" "	-
27	42	16	13	" "	" "	-
36	54	14	17	#8 Rebar	14 ga.(C), 12 ga.(F)	-
42	60	16	19	" "	" "	-
48	72	16	21	1 ½" pipe or 1 ½ x 1 ½ x ¼ angle	14 ga.(C), 10 ga.(F)	-
54	78	16	25	" "	" "	-
60	90	14	29	1 ½" pipe or 1 ½ x 1 ½ x ¼ angle	12 ga.(C), 8 ga.(F)	-
66	96	14	33	2" pipe or 2 x 2 x 3/16 angle	12 ga.(C), 8	2 x 2 x ¼ angle
72	102	14	36	" "	" "	2 ½ x 2 ½ x ¼ angle
78	114	14	39	2 ½" pipe or 2 ½ x ¼ angle	" "	" "
84	120	12	42	2 ½" pipe or 2 ½ x 2 ½ x ¼ angle	" "	2 ½ x 2 ½ x 5/16 angle

Note<sub>1</sub>: The criterion for sizing the cylinder is that the area between the inside of the cylinder and the outside of the riser is equal to or greater than the area inside the riser. Therefore, the above table is invalid for use with concrete pipe risers.  
Note<sub>2</sub>: Corrugation for 12"-36" pipe measures 2 ¾ x ½"; for 42"-84" the corrugation measures 5" x 1" or 8" x 1".  
Note<sub>3</sub>: C = corrugated; F = flat.

Source: Adapted from USDA-SCS and Carl M. Henshaw Drainage Products Information.

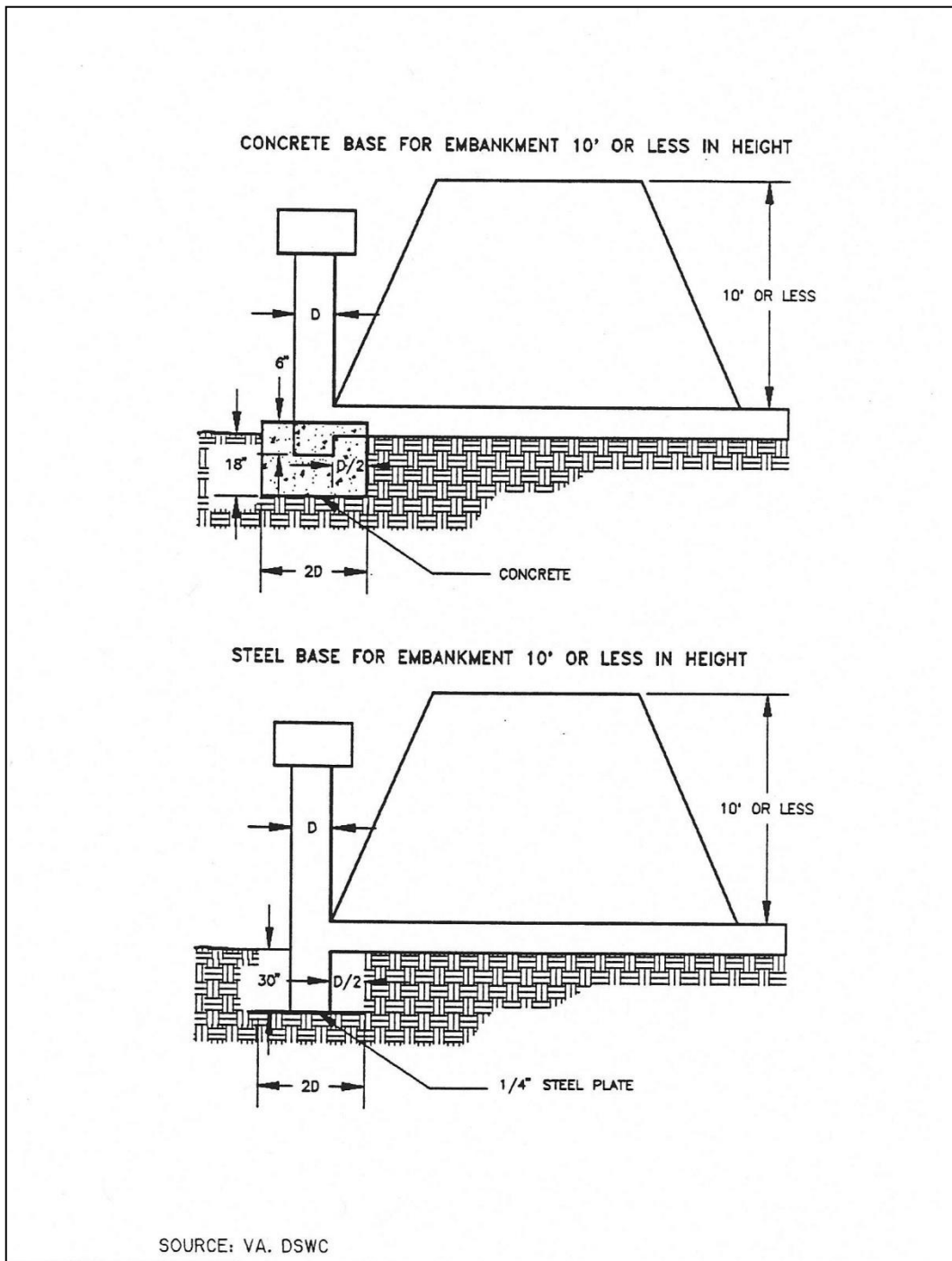


Figure 3.27 Riser Pipe Base Design for Embankment Less Than 10 Feet High

### 3.9.8 Design Form

Note: This design form is for basins designed with a riser as its primary outlet. It is provided as an example of the type of documentation required for a sediment basin. Different calculations will be needed for other types of outlets.

Project \_\_\_\_\_

Basin # \_\_\_\_\_ Location \_\_\_\_\_

Total area draining to basin: \_\_\_\_\_ acres.

Total disturbed area draining to basin: \_\_\_\_\_ acres.

#### Basin Volume Design

1. Minimum required volume is the lesser of
  - a.)  $(3600 \text{ cu. ft.} \times \text{total drainage acres}) / 27 = \text{_____ cu. yds.}$
  - b.) 2 yr, 24 hr storm volume in cubic yards = \_\_\_\_\_ cu. yds.
2. Total available basin volume at crest of riser\* = \_\_\_\_\_ cu. yds. at elevation \_\_\_\_\_.  
(From Storage - Elevation Curve)

\* Minimum = Lesser of 3600 cubic feet/acre of Total Drainage Area or  
2yr. 24 hr. storm volume from Disturbed Area drained

3. Excavate \_\_\_\_\_ cu. yds. to obtain required volume\*.  
\*Elevation corresponding to required volume = invert of the dewatering orifice.
4. Diameter of dewatering orifice = \_\_\_\_\_ in.
5. Diameter of flexible tubing = \_\_\_\_\_ in. (diameter of dewatering orifice plus 2 inches).

#### Preliminary Design Elevations

6. Crest of Riser = \_\_\_\_\_  
Top of Dam = \_\_\_\_\_  
Design High Water = \_\_\_\_\_  
Upstream Toe of Dam = \_\_\_\_\_

Basin Shape

7.  $\frac{\text{Length of Flow}}{\text{Effective Width}} = \frac{L}{We} = \underline{\hspace{2cm}}$

If  $> 2$ , baffles are not required  $\underline{\hspace{2cm}}$

If  $< 2$ , baffles are required  $\underline{\hspace{2cm}}$

Runoff

8.  $Q_2 = \underline{\hspace{2cm}}$  cfs (From TR-55)

9.  $Q_{25} = \underline{\hspace{2cm}}$  cfs (From TR-55)

Basin Outlet Design

10. With emergency spillway, required basin outlet capacity  $Q_p = Q_2 = \underline{\hspace{2cm}}$  cfs.  
(riser and outfall)

Without emergency spillway, required basin outlet capacity  $Q_p = Q_{25} = \underline{\hspace{2cm}}$  cfs.  
(riser and outfall)

11. With emergency spillway:

Assumed available head (h) =  $\underline{\hspace{2cm}}$  ft. (Using  $Q_2$ )

$h = \text{Crest of Emergency Spillway Elevation} - \text{Crest of Riser Elevation}$

Without emergency spillway:

$h = \text{Design High Water Elevation} - \text{Crest of Riser Elevation}$

12. Riser diameter ( $D_r$ ) =  $\underline{\hspace{2cm}}$  in. Actual head (h) =  $\underline{\hspace{2cm}}$  ft.

(Figure 3.23)

Note: Avoid orifice flow conditions.

13. Barrel length (l) =  $\underline{\hspace{2cm}}$  ft.

Head (H) on outfall through embankment =  $\underline{\hspace{2cm}}$  ft.

(Figure 3.24)

14. Barrel Diameter =  $\underline{\hspace{2cm}}$  in.

(From Table 3.5 [concrete pipe] or Table 3.6 [corrugated pipe]).



## 15. Trash rack and anti-vortex device

Diameter = \_\_\_\_\_ inches.

Height = \_\_\_\_\_ inches.

(From Table 3.8).

Emergency Spillway Design16. Required spillway capacity  $Q_e = Q_{25} - Q_p =$  \_\_\_\_\_ cfs.

17. Bottom width (b) = \_\_\_\_\_ ft.; the slope of the exit channel(s) = \_\_\_\_\_ ft./foot; and the minimum length of the exit channel (x) = \_\_\_\_\_ ft.

(From Figure 3.25 and Table 3.7).

Final Design Elevations

18. Top of Dam = \_\_\_\_\_

Design High Water = \_\_\_\_\_

Emergency Spillway Crest = \_\_\_\_\_

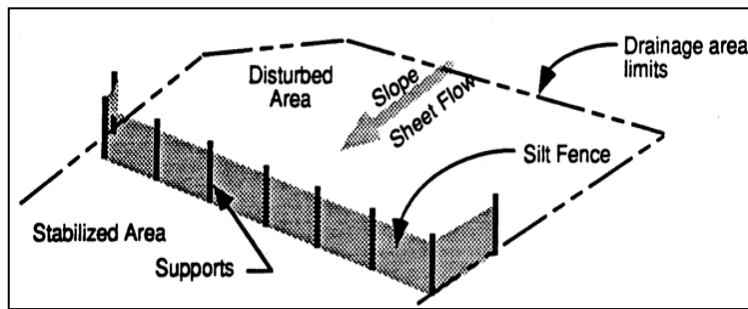
Basin Riser Crest = \_\_\_\_\_

Dewatering Orifice Invert = \_\_\_\_\_

Elevation of Upstream Toe of Dam  
(if excavation was performed) = \_\_\_\_\_

## 3.10 Silt Fence

### Sediment Control



**Description:** A silt fence consists of geotextile fabric supported by wire mesh netting or other backing stretched between metal posts with the lower edge of the fabric securely embedded six-inches in the soil. The fence is typically located downstream of disturbed areas to intercept runoff in the form of sheet flow. A silt fence provides both filtration and time for sediment settling by reducing the velocity of the runoff.

### KEY CONSIDERATIONS

#### DESIGN CRITERIA:

- Maximum drainage area of 0.25 acre per 100 linear feet of silt fence
- Maximum 200 feet distance of flow to silt fence; 50 feet if slope exceeds 10 percent
- Minimum fabric overlap of 3 feet at abutting ends; join fabric to prevent leakage
- Turn end of silt fence line upslope a minimum of 10 feet
- Install stone overflow structure at low points or spaced at approximately 300 feet if no apparent low point

#### ADVANTAGES / BENEFITS:

- Economical means to treat sheet flow
- Most effective with coarse to silty soil types

#### DISADVANTAGES / LIMITATIONS:

- Limited effectiveness with clay soils due to clogging
- Localized flooding due to minor ponding at the upslope side of the silt fence
- Not for use as check dams in swales or low areas subject to concentrated flow
- Not for use where soil conditions prevent a minimum toe-in depth of 6 inches or installation of support posts to a depth of 12 inches
- Can fail structurally under heavy storm flows, creating maintenance problems and reducing effectiveness

#### MAINTENANCE REQUIREMENTS:

- Inspect regularly
- Repair undercutting, sags and other fence failures
- Remove sediment before it reaches half the height of the fence
- Repair or replace damaged or clogged filter fabric

### TARGETED POLLUTANTS

- Sediment
- Nutrients & Toxic Materials
- Oil & Grease
- Floatable Materials
- Other Construction Wastes

### APPLICATIONS

Perimeter Control

Slope Protection

Sediment Barrier

Channel Protection

Temporary Stabilization

Final Stabilization

Waste Management

Housekeeping Practices

**Fe=0.50-0.75**

*(Depends on soil type)*

### IMPLEMENTATION CONSIDERATIONS

- Capital Costs
- Maintenance
- Training
- Suitability for Slopes > 5%

#### Other Considerations:

- *Effects of ponding or the redirection of flow onto adjacent areas and property*

### 3.10.1 Primary Use

Silt fence is normally used as a perimeter control on the down slope side of disturbed areas and on side slopes where stormwater may runoff the area. It is only feasible for non-concentrated, sheet flow conditions. If it becomes necessary to place a silt fence where concentrated flows may occur (e.g. where two silt fences join at an angle, or across minor channels or gullies), it will be necessary to reinforce the silt fence at that area by a rock berm or sand bag berm, or other structural measures that will support the silt fence.

### 3.10.2 Applications

Silt fence is an economical means to treat overland, non-concentrated flows for all types of projects. Silt fences are used as perimeter control devices for both site developers and linear (roadway) type projects. They are most effective with coarse to silty soil types. Due to the potential of clogging and limited effectiveness, silt fences should be used with caution in areas that have predominantly clay soil types. In this latter instance, a soils engineer or soil scientist should confirm the suitability of silt fence for that application. Additional controls may be needed to remove fine silts and clay soils suspended in stormwater.

### 3.10.3 Design Criteria

- Fences are to be constructed along a line of constant elevation (along a contour line) where possible.
- Silt fence can interfere with construction operations; therefore, planning of access routes onto the site is critical.
- Maximum drainage area shall be 0.25 acre per 100 linear feet of silt fence.
- Maximum flow to any 20 foot section of silt fence shall be 1 CFS.
- Maximum distance of flow to silt fence shall be 200 feet or less. If the slope exceeds 10 percent the flow distance shall be less than 50 feet.
- Maximum slope adjacent to the fence shall be 2:1.
- Silt fences shall not be used where there is a concentration of water in a channel, drainage ditch or swale, nor should it be used as a control on a pipe outfall.
- If 50 percent or less soil, by weight, passes the U.S. Standard Sieve No. 200; select the apparent opening size (A.O.S.) to retain 85percent of the soil.
- If 85 percent or more of soil by weight, passes the U.S. Standard Sieve No. 200, silt fences shall not be used unless the soil mass is evaluated and deemed suitable by a soil scientist or geotechnical engineer concerning the erodibility of the soil mass, dispersive characteristics, and the potential grain-size characteristics of the material that is likely to be eroded.
- Stone overflow structures or other outlet control devices shall be installed at all low points along the fence or spaced at approximately 300 feet if there is no apparent low point.
- Filter stone for overflow structure shall be 1 ½ inches washed stone containing no fines. Angular shaped stone is preferable to rounded shapes.
- Silt fence fabric must meet the following minimum criteria:
  - Tensile Strength, ASTM D4632 Test Method for Grab Breaking Load and Elongation of Geotextiles, 90-lbs.
  - Puncture Rating, ASTM D4833 Test Method for Index Puncture Resistance of Geotextiles, Geomembranes, and Related Products, 60-lbs.
  - Mullen Burst Rating, ASTM D3786 Standard Test Method for Hydraulic Bursting Strength of Textile Fabrics-Diaphragm Bursting Strength Tester Method, 280-psi.

- Apparent Opening Size, ASTM D4751 Test Method for Determining Apparent Opening Size of a Geotextile, U.S. Sieve No. 30(max) to No. 100 (min).
- Ultraviolet Resistance, ASTM D4355 Standard Test Method for Deterioration of Geotextiles by Exposure to Light, Moisture, and Heat in a Xenon Arc Type Apparatus, Minimum 70 percent.
- Fence posts shall be steel and may be T-section or L-section, 1.3 pounds per linear foot minimum, and 4 feet in length minimum. Wood posts may be used depending on anticipated length of service and provided they are 4 feet in length minimum and have a nominal cross section of 2 inches by 4 inches for pine or 2 inches by 2 inches for hardwoods.
- Silt fence shall be supported by steel wire fence fabric as follows:
  - 4 inch x 4 inch mesh size, W1.4 /1.4, minimum 14 gauge wire fence fabric;
  - Hog wire, 12 gauge wire, small openings installed at bottom of silt fence;
  - Standard 2 inch x 2 inch chain link fence fabric; or
  - Other welded or woven steel fabrics consisting of equal or smaller spacing as that listed herein and appropriate gauge wire to provide support.
- Silt Fence shall consist of synthetic fabric supported by wire mesh and steel posts set a minimum of 1-foot depth and spaced not more than 6-feet on center.
- A 6 inch wide trench is to be cut 6 inches deep at the toe of the fence to allow the fabric to be laid below the surface and backfilled with compacted earth or gravel to prevent bypass of runoff under the fence. Fabric shall overlap at abutting ends a minimum of 3 feet and shall be joined such that no leakage or bypass occurs. If soil conditions prevent a minimum toe-in depth of 6 inches or installation of support post to depth of 12 inches, silt fences shall not be used.
- Sufficient room for the operation of sediment removal equipment shall be provided between the silt fence and other obstructions in order to properly maintain the fence.
- The last 10 feet (or more) at the ends of a line of silt fence shall be turned upslope to prevent bypass of stormwater. Additional upslope runs of silt fence may be needed every 200 to 400 linear feet, depending on the traverse slope along the line of silt fence.

### *3.10.4 Design Guidance and Specifications*

Specifications for construction of this item may be found in the Standard Specifications for Public Works Construction – North Central Texas Council of Governments, Section 201.5 Silt Fence and in the Standard Specifications for Construction and Maintenance of Highways, Streets and Bridges (TxDot 2004) Item 506.2.J and Item 506.4.C.9.

The American Society for Testing and Materials has established standard specifications for silt fence materials (ASTM D6461) and silt fence installation (ASTM D6462).

### *3.10.5 Inspection and Maintenance Requirements*

Silt fence should be inspected regularly (at least as often as required by the TPDES Construction General Permit) for buildup of excess sediment, undercutting, sags, and other failures. Sediment should be removed before it reaches half the height of the fence. In addition, determine the source of excess sediment and implement appropriate measures to control the erosion. Damaged or clogged fabric must be repaired or replaced as necessary.

### 3.10.6 *Example Schematics*

The following schematics are example applications of the construction control. They are intended to assist in understanding the control's design and function.

The schematics are **not for construction**. They may serve as a starting point for creating a construction detail, but they must be site adapted by the designer. In addition, dimensions and notes appropriate for the application must be added by the designer.

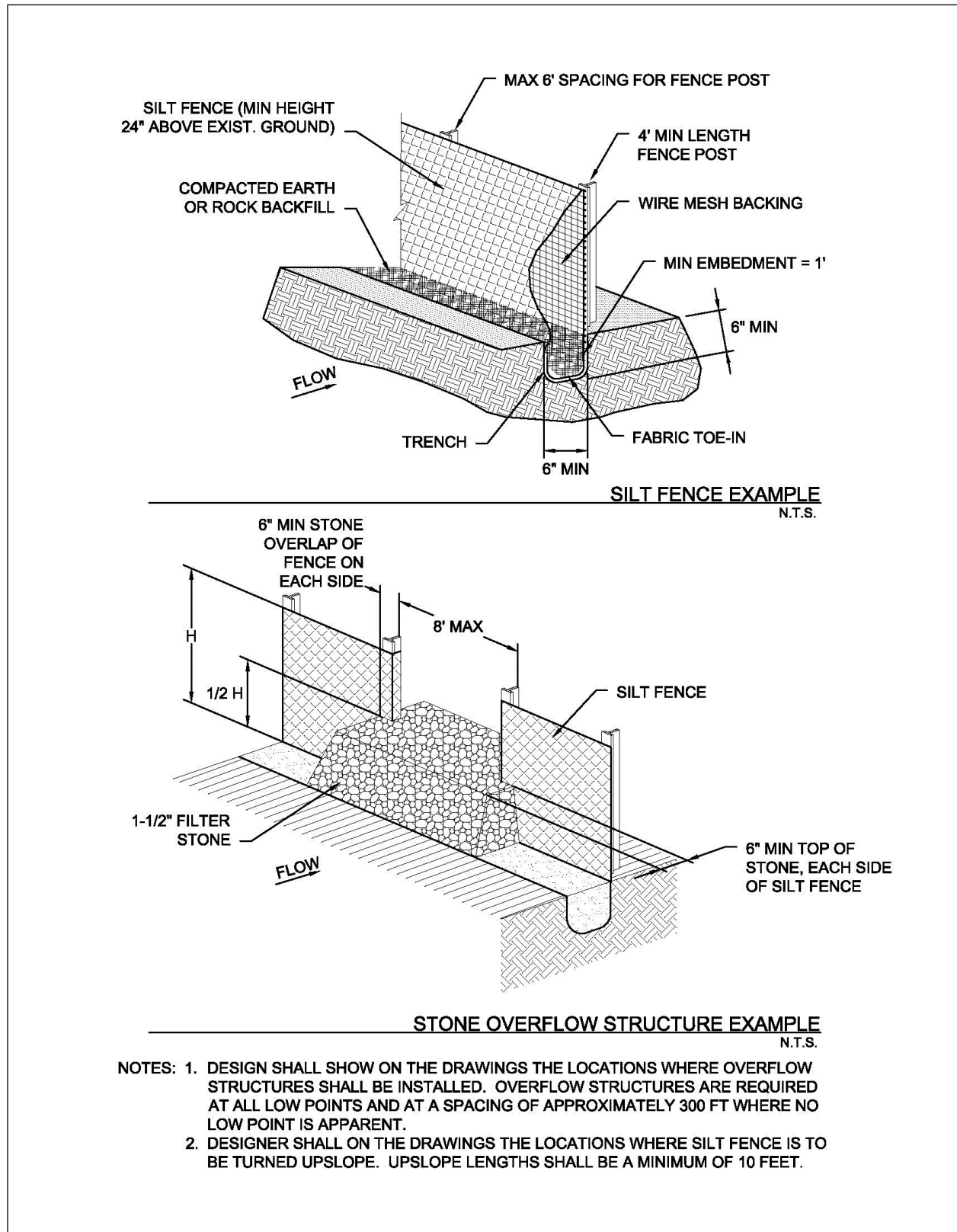
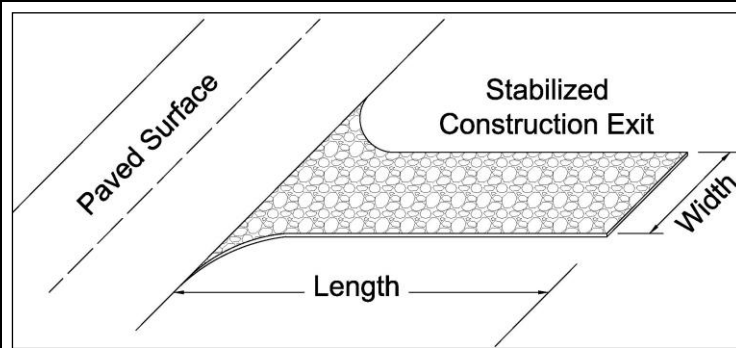


Figure 3.28 Schematics of Silt Fence

### 3.11 Stabilized Construction Exit

Sediment Control



**Description:** A stabilized construction exit is a pad of crushed stone, recycled concrete or other rock material placed on geotextile filter cloth to dislodge soil and other debris from construction equipment and vehicle tires prior to exiting the construction site. The object is to minimize the tracking of soil onto public roadways where it will be suspended by stormwater runoff.

**KEY CONSIDERATIONS**

**DESIGN CRITERIA:**

- Slope exit away from offsite paved surface
- Minimum width and length dependent on size of disturbed area, which correlates to traffic volume
- 6 inches minimum thickness of stone layer
- Stone of 3 to 5 inches in size
- Add a wheel cleaning system when inspections reveal the stabilized exit does not prevent tracking

**ADVANTAGES / BENEFITS:**

- Reduces tracking of soil onto public streets
- Directs traffic to a controlled access point
- Protects other sediment controls by limiting the area disturbed

**DISADVANTAGES / LIMITATIONS:**

- Effectiveness dependent on limiting ingress and egress to the stabilized exit
- A wheel washing system may also be required to remove clay soil from tires, particularly in wet conditions

**MAINTENANCE REQUIREMENTS:**

- Inspect regularly
- Replace rock when sediment in the void area between the rocks is visible on the surface
- Periodically re-grade and top dress with additional stone to maintain efficiency

**APPLICATIONS**

- Perimeter Control
- Slope Protection
- Sediment Barrier
- Channel Protection
- Temporary Stabilization**
- Final Stabilization
- Waste Management
- Housekeeping Practices

**Fe=N/A**

**IMPLEMENTATION CONSIDERATIONS**

- Capital Costs
- Maintenance
- Training
- Suitability for Slopes > 5%

**Other Considerations:**

- None

**TARGETED POLLUTANTS**

- Sediment
- Nutrients & Toxic Materials
- Oil & Grease
- Floatable Materials
- Other Construction Wastes

### 3.11.1 Primary Use

Stabilized construction exits are used to remove soil, mud and other matter from vehicles that drive off of a construction site onto public streets. Stabilized exits reduce the need to remove sediment from streets. When used properly, they also control traffic by directing vehicles a single (or two for larger sites) location. Controlling traffic onto and off of the site reduces the number and quantity of disturbed areas and provides protection for other sediment controls by decreasing the potential for vehicles to drive over the control.

### 3.11.2 Applications

Stabilized construction exits are used on all construction sites with a disturbed area of one acre or larger and are a recommended practice for smaller construction sites. A stabilized exit is used on individual residential lots until the driveway is placed. Stabilized construction exits may be used in conjunction with wheel cleaning systems as described in [Section 3.16 Wheel Cleaning Systems](#).

### 3.11.3 Design Criteria

- Limit site access to one route during construction, if possible; two routes for linear and larger projects.
- Prevent traffic from avoiding or shortcutting the full length of the construction exit by installing barriers. Barriers may consist of silt fence, construction safety fencing, or similar barriers.
- Design the access point(s) to be at the upslope side of the construction site. Do not place construction access at the lowest point on the construction site.
- Stabilized construction exits are to be constructed such that drainage across the exit is directed to a controlled, stabilized outlet onsite with provisions for storage, proper filtration, and removal of wash water.
- The exit must be sloped away from the paved surface so that stormwater from the site does not discharge through the exit onto roadways.
- Minimum width of exit shall be 15 feet.
- The construction exit material shall be a minimum thickness of 6 inches. The stone or recycled concrete used shall be 3 to 5 inches in size with little or no fines.
- The geotextile fabric must meet the following minimum criteria:
  - Tensile Strength, ASTM D4632 Test Method for Grab Breaking Load and Elongation of Geotextiles, 300 lbs.
  - Puncture Strength, ASTM D4833 Test Method for Index Puncture Resistance of Geotextiles, Geomembranes, and Related Products, 120 lbs.
  - Mullen Burst Rating, ASTM D3786 Standard Test Method for Hydraulic Bursting Strength of Textile Fabrics-Diaphragm Bursting Strength Tester Method, 600 psi.
  - Apparent Opening Size, ASTM D4751 Test Method for Determining Apparent Opening Size of a Geotextile, U.S. Sieve No. 40 (max).
- Rock by itself may not be sufficient to remove clay soils from wheels, particularly in wet conditions. When necessary, vehicles must be cleaned to remove sediment prior to entering paved roads, streets, or parking lots. Refer to [Section 3.16 Wheel Cleaning Systems](#) for additional controls.
- Using water to wash sediment from streets is prohibited
- Minimum dimensions for the stabilized exit shall be as follows:



<b><i>Disturbed Area</i></b>	<b><i>Min. Width of Exit</i></b>	<b><i>Min. Length of Exit</i></b>
< 1 Acre	15 feet	20 feet
≥ 1 Acre but < 5 Acres	25 feet	50 feet
≥ 5 Acres	30 feet	50 feet

- If a wheel cleaning system is used, the width of the stabilized exit may be reduced to funnel traffic into the system. Refer to [Section 3.16 Wheel Cleaning](#).

### ***3.11.4 Design Guidance and Specifications***

Specifications for construction of this item may be found in the Standard Specifications for Public Works Construction – North Central Texas Council of Governments, Section 201.10 Stabilized Construction Entrance and in the Standard Specifications for Construction and Maintenance of Highways, Streets and Bridges (TxDOT 2004) Item 506.2.E and Item 506.4.C.5.

### ***3.11.5 Inspection and Maintenance Requirements***

Construction exits should be inspected regularly (at least as often as required by the TPDES Construction General Permit). The stabilized construction exit shall be maintained in a condition that prevents tracking or flow of sediment onto paved surfaces. Periodic re-grading and top dressing with additional stone must be done to keep the efficiency of the exit from diminishing. The rock shall be re-graded when ruts appear. Additional rock shall be added when soil is showing through the rock surface.

Additional controls are needed if inspections reveal a properly installed and maintained exit, but tracking of soil outside the construction area is still evident. Additional controls may be daily sweeping of all soil spilled, dropped, or tracked onto public rights-of-way or the installation of a wheel cleaning system.

### ***3.11.6 Example Schematics***

The following schematics are example applications of the construction control. They are intended to assist in understanding the control's design and function.

The schematics are **not for construction**. They may serve as a starting point for creating a construction detail, but they must be site adapted by the designer. In addition, dimensions and notes appropriate for the application must be added by the designer.

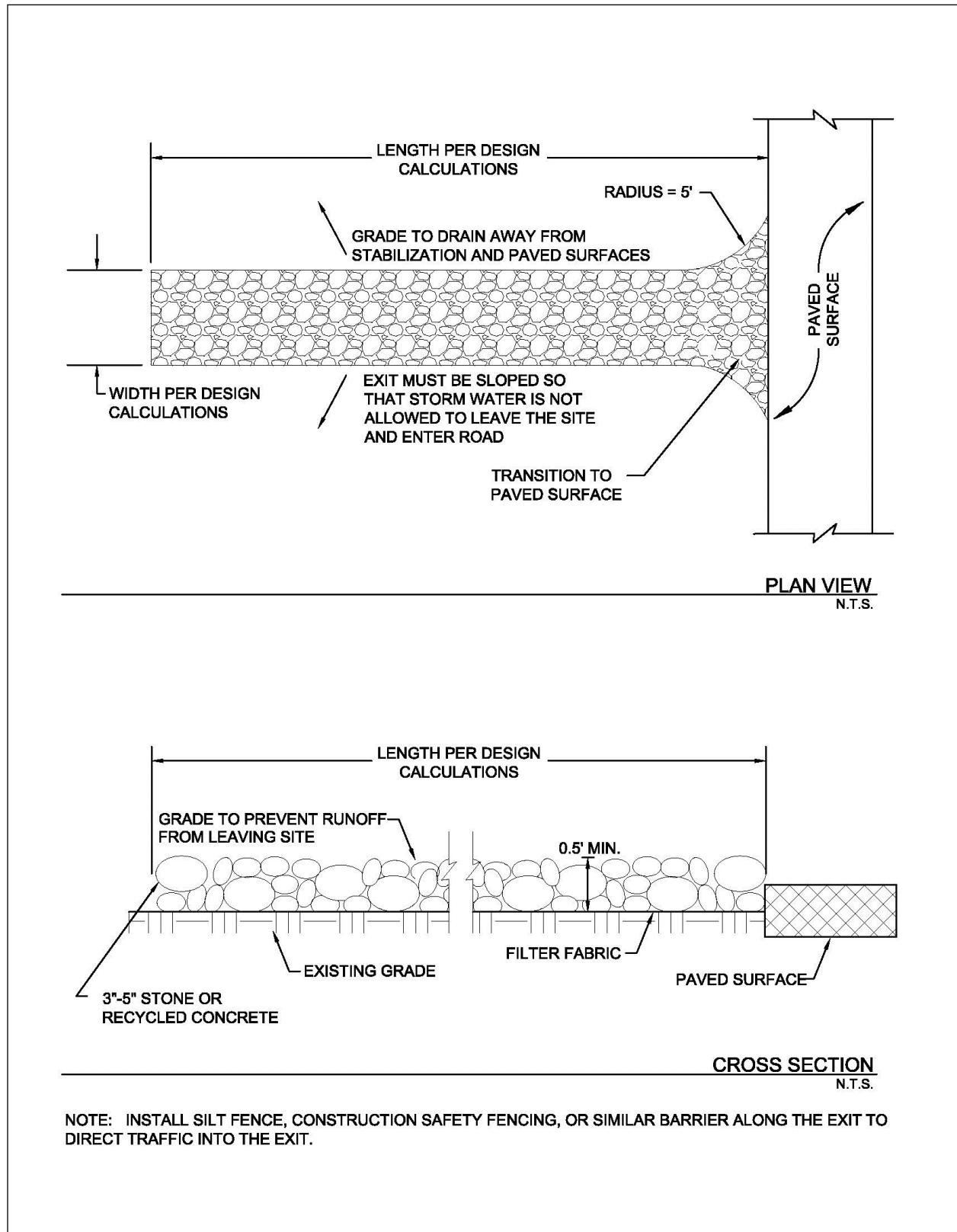
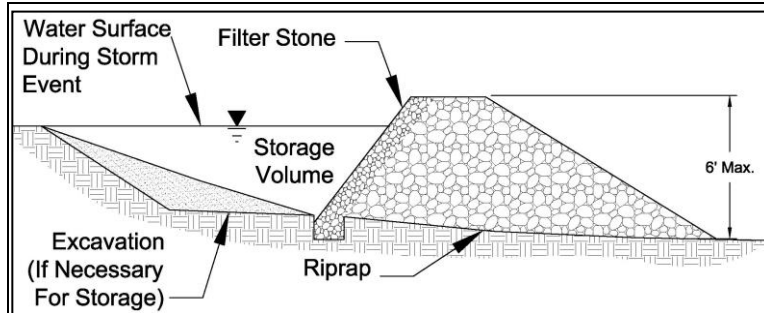


Figure 3.29 Schematics of Stabilized Construction Exit

### 3.12 Stone Outlet Sediment Trap

Sediment Control



**Description:** A stone outlet sediment trap is a small detention area formed by placing a stone embankment with an integral stone filter outlet across a drainage swale for the purpose of detaining sediment-laden runoff from construction activities. The sediment trap detains runoff long enough to allow most of the suspended sediment to settle while still allowing for diffused flow of runoff.

**KEY CONSIDERATIONS**

**DESIGN CRITERIA:**

- Maximum contributing drainage area of 10 acres for excavated trap and 5 acres for bermed trap
- Provide storage volume for the 2-year, 24-hour design storm
- Maximum embankment height of 6 feet
- Embankment slope of 1.5:1 or flatter
- 2 foot minimum top width

**ADVANTAGES / BENEFITS:**

- Effectively traps sediment in a drainage swale
- Reduces flow velocities
- Relatively long effective life

**DISADVANTAGES / LIMITATIONS:**

- Amount of land required
- Can cause minor upstream flooding, possibly impacting construction operations
- Not for use in "live" (normally flowing) channels

**MAINTENANCE REQUIREMENTS:**

- Inspect regularly
- Replace filter stone when it appears to be silted in such that efficiency is diminished
- Remove trash and debris after each storm event
- Remove deposited sediment when before the storage capacity is reduced by one third or has reached a depth of one foot, whichever is less

**TARGETED POLLUTANTS**

- Sediment
- Nutrients & Toxic Materials
- Oil & Grease
- Floatable Materials
- Other Construction Wastes

**APPLICATIONS**

- Perimeter Control
- Slope Protection
- Sediment Barrier**
- Channel Protection
- Temporary Stabilization
- Final Stabilization
- Waste Management
- Housekeeping Practices

**Fe=0.50-0.85**

*(Depends on soil type)*

**IMPLEMENTATION CONSIDERATIONS**

- Capital Costs
- Maintenance
- Training
- Suitability for Slopes > 5%

**Other Considerations:**

- *Re-grading and stabilization of the control area after construction*

### 3.12.1 Primary Use

A sediment trap is used where flows are concentrated in a drainage swale or channel. The sediment trap detains and temporarily impounds stormwater, which allows for settling of sediment as the water is slowly discharged from the trap. Sediment traps may be used in combination with check dams when erosive velocities exist in the swale upstream of the sediment trap.

### 3.12.2 Applications

Temporary stone outlet sediment traps are installed at locations where concentrated flows require a protected outlet to contain sediment or spread flow prior to discharge. They are an effective, long term (12 – 18 months) application for sediment control on large construction sites where a sediment basin is not feasible due to site or construction method restrictions. Several traps may be used to control sediment on drainage sub-basins within the construction site, instead of one large sediment basin at the discharge point from the entire construction site. Sediment traps may also be used with a passive treatment system to provide better removal of fine silt and clay soil particles.

### 3.12.3 Design Criteria

- Design calculations are required for the use of this control. The designer shall provide drainage computations and dimensions for the stone outlet, berms, and excavated areas associated with this control.
- The maximum drainage area contributing to the trap shall be less than 10 acres for the excavated stone outlet sediment trap and 5 acres or less for the bermed trap.
- The minimum storage volume shall be the volume of runoff from the temporary control design storm (2-year, 24 hour) for the sediment trap's drainage area.
- The surface area of the design storage area shall not be less than 1 percent of the area draining to the device.
- The maximum height of the rock shall be 6 feet, as measured from the toe of the slope on the downstream side to the low point in the rock dam.
- Minimum width of the rock dam at the top shall be 2 feet.
- Rock dam slope shall be 1.5:1 or flatter.
- The rock dam shall have a depressed area, over the center of swale, to serve as the outlet with a minimum width of 4 feet.
- A six inch minimum thickness layer of 1½ inch filter stone shall be placed on the upstream face of the stone embankment when the stormwater runoff contains fine silt and clay soil particles.
- The embankment shall be comprised of well graded stone with a size range of 6 to 12 inches in diameter. The stone may be enclosed in wire mesh or gabion basket and anchored to the channel bottom to prevent washing away.
- The dam shall consist of stone riprap or a combination of compacted fill with a stone riprap outlet.
- Fill placed to constrict the swale for construction of the excavated stone outlet sediment trap and fill placed for the berm in the bermed stone outlet sediment trap shall consist of clay material, minimum Plasticity Index of 30, using ASTM D4318 Standard Test for Liquid Limit, Plastic Limit, and Plasticity Index of Soils.
- Fill shall be placed in 8 inch loose lifts (maximum) and compacted to 95% Standard Proctor Density at optimum moisture content using ASTM D698 Standard Test Methods for Laboratory Compaction Characteristics of Soil Using Standard Effort.
- The outlet shall be designed to have a minimum freeboard of 6" at design flow.

- Rock shall be placed on geotextile filter fabric meeting the following minimum criteria:
  - Tensile Strength, ASTM D4632 Test Method for Grab Breaking Load and Elongation of Geotextiles, 250-lbs.
  - Puncture Rating, ASTM D4833 Test Method for Index Puncture Resistance of Geotextiles, Geomembranes, and Related Products, 135-lbs.
  - Mullen Burst Rating, ASTM D3786 Standard Test Method for Hydraulic Bursting Strength of Textile Fabrics-Diaphragm Bursting Strength Tester Method, 420-psi.
  - Apparent Opening Size, ASTM D4751 Test Method for Determining Apparent Opening Size of a Geotextile, U.S. Sieve No. 20 (max).
- The geotextile fabric, covered with a layer of stone, shall extend past the base of the embankment on the downstream side a minimum of 2 feet.

### *3.12.4 Design Guidance and Specifications*

Specifications for construction of this item may be found in the Standard Specifications for Public Works Construction – North Central Texas Council of Governments, Section 201.12 Stone Outlet Sediment Trap.

### *3.12.5 Inspection and Maintenance Requirements*

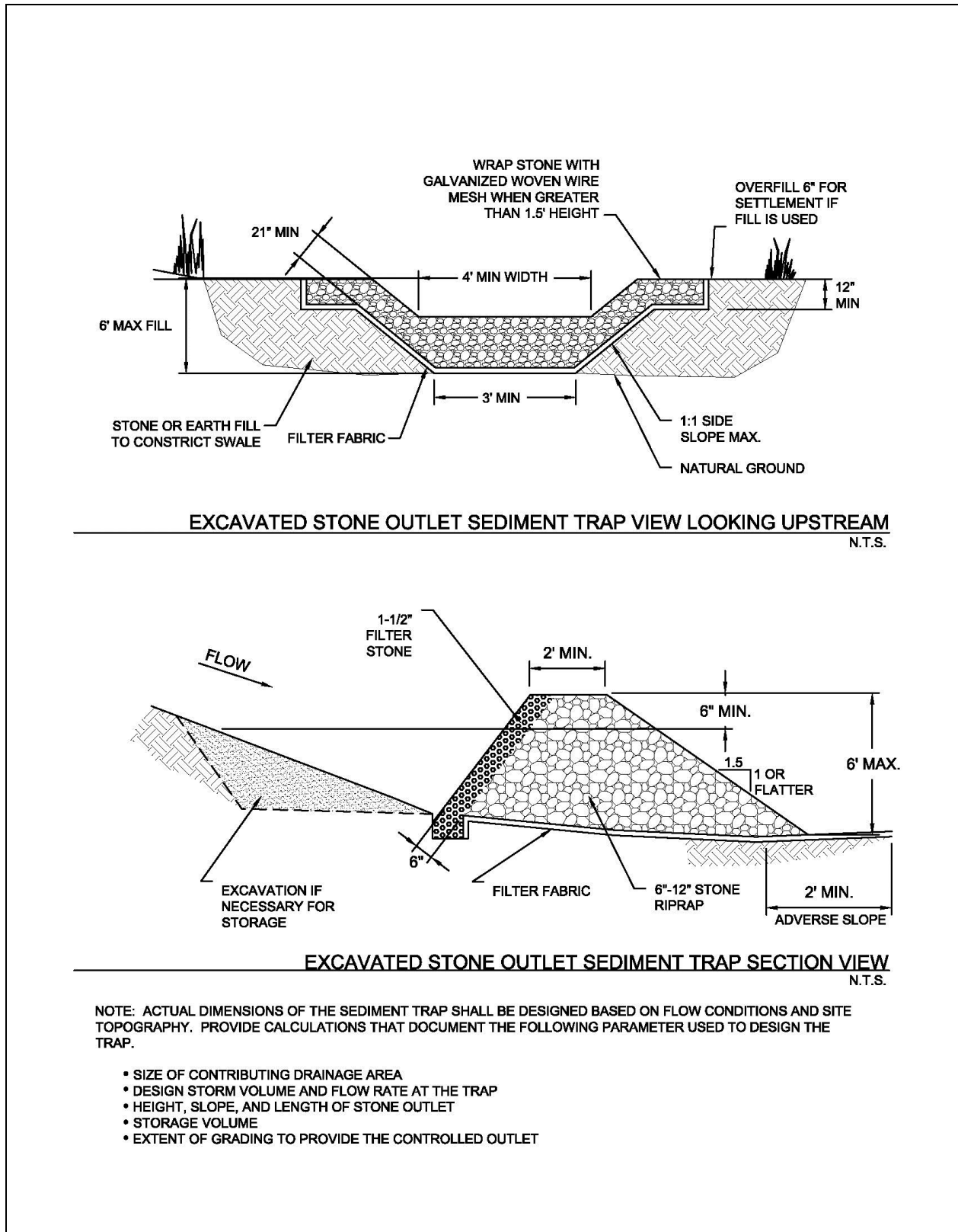
The stone outlet sediment trap should be inspected regularly (at least as often as required by the TPDES Construction General Permit) to check for clogging of the void spaces between stones. If the filter stone appears to be clogged, such that the basin will not completely drain, then the filter stone will require maintenance. If the filter stone is not completely clogged it may be raked with a garden rake to allow the water to release from the basin. If filter stone is completely clogged with mud and sediment, then the filter stone will have to be removed and replaced. Failure to keep the filter stone material properly maintained will lead to clogging of the stone riprap embankment. When this occurs, the entire stone rip-rap structure will need to be replaced. If the aggregate appears to be silted in such that efficiency is diminished, the stone should be replaced.

Trash and debris should be removed from the trap after each storm event to prevent it from plugging the rock. Deposited sediment shall be removed before the storage capacity is decreased by one-third, or sediment has reached a depth of one foot, whichever is less. The removed sediment shall be stockpiled or redistributed in areas that are protected with erosion and sediment controls.

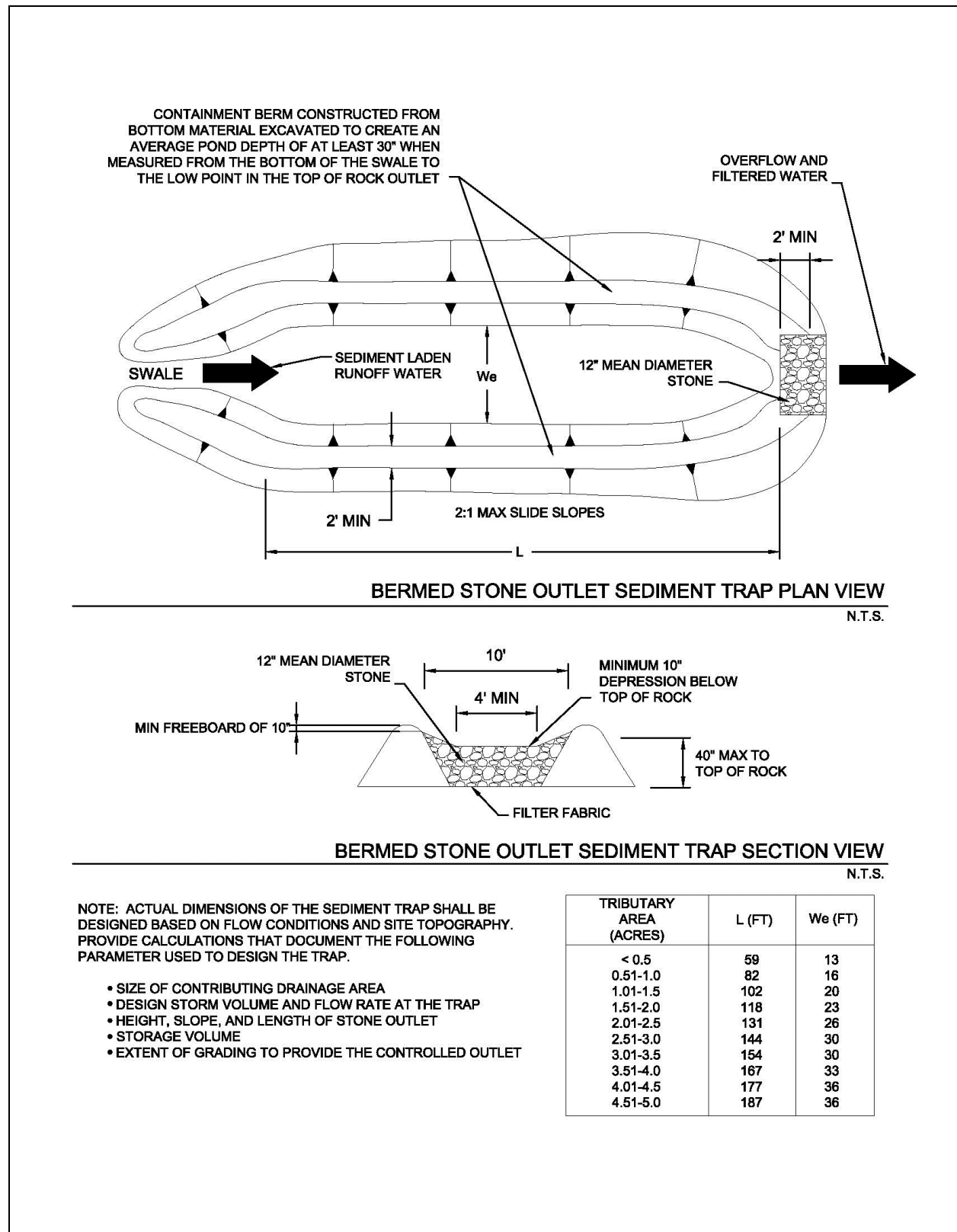
### *3.12.6 Example Schematics*

The following schematics are example applications of the construction control. They are intended to assist in understanding the control's design and function.

The schematics are **not for construction**. They may serve as a starting point for creating a construction detail, but they must be site adapted by the designer. In addition, dimensions and notes appropriate for the application must be added by the designer.



**Figure 3.30 Schematics of Excavated Stone Outlet Sediment Trap**

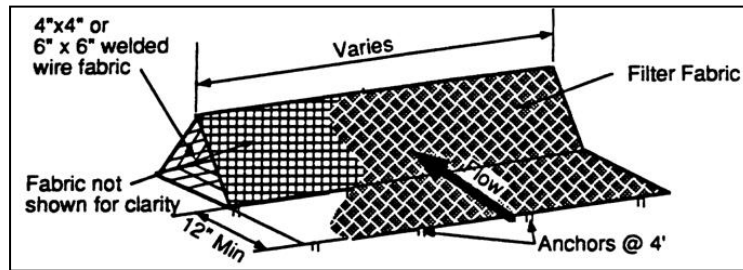


**Figure 3.31 Schematics of Bermed Stone Outlet Sediment Trap**

(Source: City of Chesterfield Department of Public Works Detail SC 7.2)

## 3.13 Triangular Sediment Filter Dike

Sediment Control



**Description:** A triangular sediment filter dike is a self-contained silt fence consisting of filter fabric wrapped around welded wire fabric and shaped into a triangular cross section. While similar in use to a silt fence, the dike is reusable, sturdier, transportable, and can be used on paved areas or in situations where it is impractical to install embedded posts for support.

### KEY CONSIDERATIONS

#### **DESIGN CRITERIA:**

- Maximum drainage area of 0.25 acre per 100 linear feet of dike
- Maximum 200 feet distance of flow to filter dike; 50 feet if slope exceeds 10 percent
- Overlap ends of filter material 6 inches to cover dike-to-dike junction; secure with shoat rings

#### **ADVANTAGES / BENEFITS:**

- Can be installed on paved surfaces or where the soil type prevents embedment of other controls
- Withstands more concentrated flow and higher flow rates than silt fence

#### **DISADVANTAGES / LIMITATIONS:**

- Localized flooding due to minor ponding at the upslope side of the filter dike
- Not effective where there are substantial concentrated flows
- Not effective along contours due to the potential for flow concentration and overtopping

#### **MAINTENANCE REQUIREMENTS:**

- Inspect regularly
- Remove sediment before it reaches 6 inches in depth
- Clean or replace fabric if clogged
- Repair or replace dike when structural deficiencies are found

### TARGETED POLLUTANTS

- Sediment
- Nutrients & Toxic Materials
- Oil & Grease
- Floatable Materials
- Other Construction Wastes

### APPLICATIONS

**Perimeter Control**

**Slope Protection**

**Sediment Barrier**

**Channel Protection**

**Temporary Stabilization**

**Final Stabilization**

**Waste Management**

**Housekeeping Practices**

**Fe=0.50-0.75**

*(Depends on soil type)*

### IMPLEMENTATION CONSIDERATIONS

- Capital Costs
- Maintenance
- Training
- Suitability for Slopes > 5%

#### **Other Considerations:**

- *Effects of ponding on adjacent areas and property*



### 3.13.1 Primary Use

Triangular filter dikes are used in place of silt fence, treating sediment flow at the perimeter of construction areas and at the perimeter of the site. Also, the dikes can serve as stream protection devices by preventing sediment from entering the streams or as check dams in small swales.

Triangular sediment filter dikes are especially useful for construction areas surrounded by pavement, where silt fence, filter berm, or other sediment control installations are impractical.

### 3.13.2 Applications

Triangular dikes are used to provide perimeter control by detaining sediment on a disturbed site with drainage that would otherwise flow onto adjacent properties. Triangular dikes function as sediment trapping devices when used in areas of sheet flow across disturbed areas or are placed along stream banks to prevent sediment-laden sheet flow from entering the stream. The dikes can be subjected to more concentrated flows and a higher flow rate than silt fence.

Dikes can be used on a variety of surfaces where other controls are not effective. They may be installed on paved surfaces and where the soil type prevents embedment of other sediment controls.

### 3.13.3 Design Criteria

- Dikes are to be installed along a line of constant elevation (along a contour line).
- Maximum drainage area shall be 0.25 acre per 100 linear feet of dike.
- Maximum flow to any 20 foot section of dike shall be 1 CFS.
- Maximum distance of flow to dike shall be 200 feet or less. If the slope exceeds 10 percent, the flow distance shall be less than 50 feet.
- Maximum slope adjacent to the dike shall be 2:1.
- If 50 percent or less of soil, by weight, passes the U.S. Standard Sieve No. 200, select the apparent opening size (A.O.S.) to retain 85 percent of the soil.
- If 85 percent or more of soil, by weight, passes the U.S. Standard Sieve No. 200, triangular sediment dike shall not be used due to clogging.
- The filter fabric shall meet the following minimum criteria:
  - Tensile Strength, ASTM D4632 Test Method for Grab Breaking Load and Elongation of Geotextiles 90-lbs.
  - Puncture Rating, ASTM D4833 Test Method for Index Puncture Resistance of Geotextiles, Geomembranes, and Related Products, 60-lbs.
  - Mullen Burst Rating, ASTM D3786 Standard Test Method for Hydraulic Bursting Strength of Textile Fabrics-Diaphragm Bursting Strength Tester Method, 280-psi.
  - Apparent Opening Size, ASTM D4751 Test Method for Determining Apparent Opening Size of a Geotextile, U.S. Siev No. 30 (max) to 100 (min).
  - Ultraviolet Resistance, ASTM D4355 Standard Test Method for Deterioration of Geotextiles by Exposure to Light, Moisture, and Heat in a Xenon Arc Type Apparatus, Minimum 70 percent.
- The internal support for the dike structure shall be 6-gauge 6 inch x 6 inch wire mesh or 6-gauge 4 inch x 4 inch welded wire fabric folded into triangular form eighteen (18) inches on each side.
- Tie-in to the existing grade should be accomplished by:
  - (i) embedding the fabric six-inches below the top of ground on the upslope side;

- (ii) extending the fabric to form a 12 inch skirt on the upstream slope and covering it with 3 to 5 inches of 1½ inch washed filter stone; or
- (iii) entrenching the base of the triangular dike four inches below ground.

For (ii) above, the skirt and the upslope portion of the triangular dike skeleton should be anchored by metal staples on two-foot centers, driven a minimum of six inches into the ground (except where crossing pavement or exposed limestone). When installed on pavement, the washed rock in option (ii) may be replaced by bags filled with 1½ inch washed filter stone placed at 4 foot spacing to anchor the end of the filter fabric to the pavement.

- Filter material shall lap over ends six (6) inches to cover dike-to-dike junction; each junction shall be secured by shoat rings. Where the dike is placed on pavement, two rock bags shall be used to anchor the overlap to the pavement. Additional bags shall be used as needed to ensure continuous contact with the pavement (no gaps).
- Sand bags or large rock should be used as ballast inside the triangular dike section to stabilize the dike against the effects of high flows.
- Sufficient room for the operation of sediment removal equipment shall be provided between the dike and other obstructions in order to properly remove sediment.
- The ends of the dike shall be turned upgrade to prevent bypass of stormwater.
- When used as a perimeter control on drainage areas larger than 0.5 acres, a stone overflow structure, similar to the one shown in [Section 3.10 Silt Fence](#), may be necessary at low points to act as a controlled overflow point in order to prevent localized flooding and failure of the dike.
- If used as check dams in small swales (drainage areas less than 3 acres), the dikes shall be installed according to the spacing and other criteria in [Section 2.1 Check Dam](#).

### 3.13.4 Design Guidance and Specifications

Specifications for construction of this item may be found in the Standard Specifications for Public Works Construction – North Central Texas Council of Governments, Section 201.8 Triangular Sediment Filter Dike.

### 3.13.5 Inspection and Maintenance Requirements

Triangular sediment filter dikes should be inspected regularly (at least as often as required by the TPDES Construction General Permit). Sediment should be removed before it reaches 6 inches in depth. If the fabric becomes clogged, it should be cleaned or, if necessary, replaced. If structural deficiencies are found, the dike should be immediately repaired or replaced.

The integrity of the filter fabric is important to the effectiveness of the dike. Overlap between dike sections must be checked on a regular basis and repaired if deficient.

### 3.13.6 Example Schematics

The following schematics are example applications of the construction control. They are intended to assist in understanding the control's design and function.

The schematics are **not for construction**. They may serve as a starting point for creating a construction detail, but they must be site adapted by the designer. In addition, dimensions and notes appropriate for the application must be added by the designer.

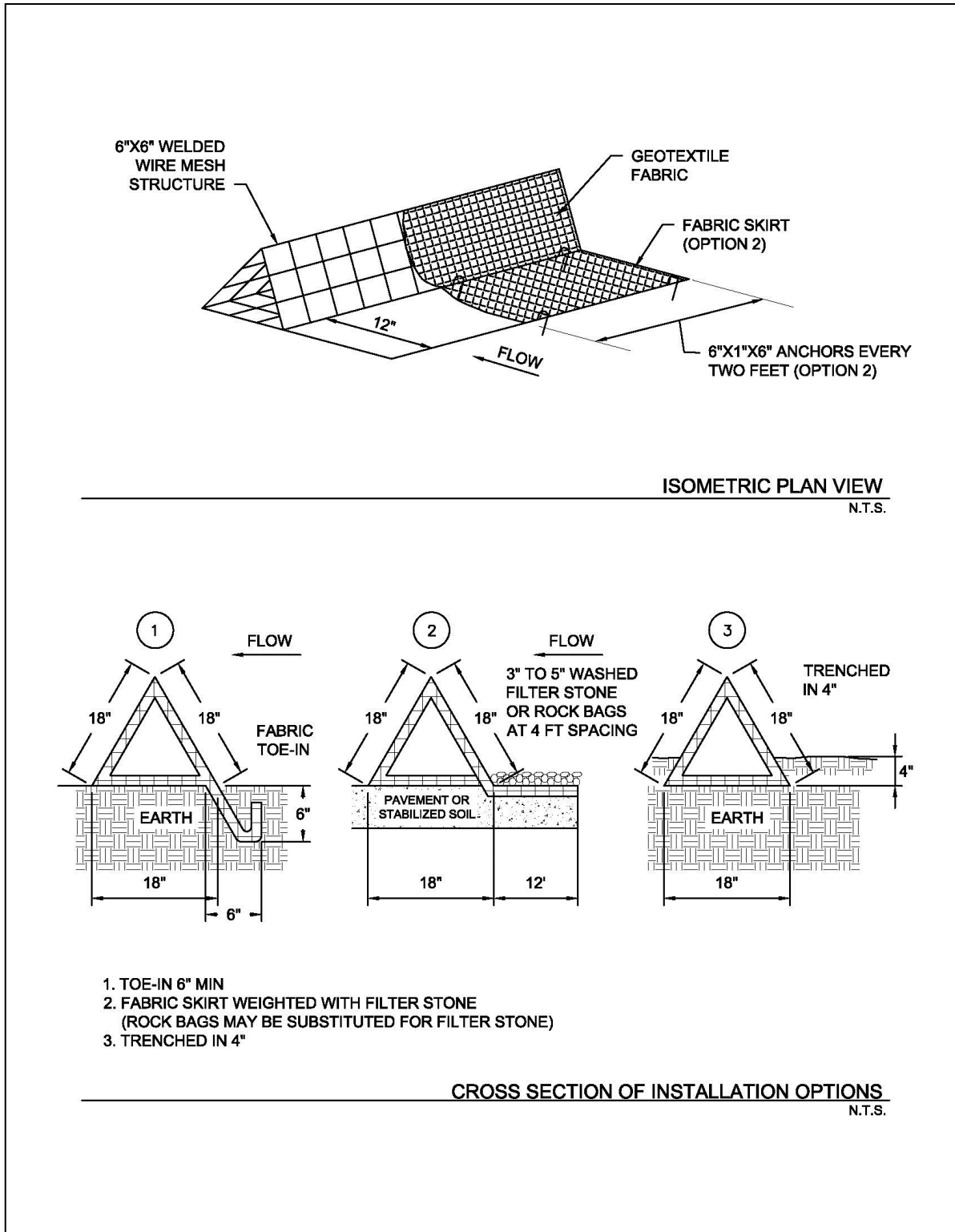
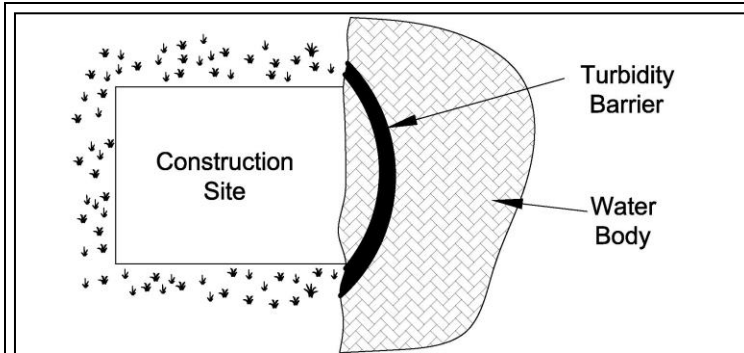


Figure 3.32 Schematics of Triangular Sediment Filter Dike

### 3.14 Turbidity Barrier

**Sediment Control**



**Description:** A turbidity barrier is a floating geotextile or PVC curtain that is designed to control sediment within a body of water. It is also known as a floating silt barrier or turbidity/silt curtain. The barrier typically consists of floats, curtain, ballast, and anchor lines. The barrier may be permeable or impermeable. Barriers of 100 feet or longer are constructed of a series of connected panels.

**KEY CONSIDERATIONS**

**DESIGN CRITERIA:**

- Barrier specified based on depths and velocities in the water body in which the barrier is installed
- Installation and anchoring according to manufacturer's recommendations
- Height of barrier 10 percent greater than design water depth
- Specified length of barrier 10 to 20 percent greater than design length

**ADVANTAGES / BENEFITS:**

- Controls sediment from construction activities where other types of down slope barriers are infeasible
- Protects sensitive wetlands and water bodies
- May be re-used on different projects

**DISADVANTAGES / LIMITATIONS:**

- Limited usefulness in water bodies with high velocities
- May be damaged by a large storm event
- Barrier can be difficult to remove when under heavy sediment accumulations

**MAINTENANCE REQUIREMENTS:**

- Inspect regularly
- Repair or replace fabric as needed
- Re-anchor if dislodged

**TARGETED POLLUTANTS**

- Sediment
- Nutrients & Toxic Materials
- Oil & Grease
- Floatable Materials
- Other Construction Wastes

**APPLICATIONS**

**Perimeter Control**

**Slope Protection**

**Sediment Barrier**

**Channel Protection**

**Temporary Stabilization**

**Final Stabilization**

**Waste Management**

**Housekeeping Practices**

**Fe=0.50-0.90**

*(Depends on soil type)*

**IMPLEMENTATION CONSIDERATIONS**

- Capital Costs
- Maintenance
- Training
- Suitability for Slopes > 5%

**Other Considerations:**

- *Conflicts with boat traffic*

### 3.14.1 Primary Use

Turbidity barriers are used when construction activities will disturb the bank of a perennial stream, river, pond, or lake. They are also used when construction activities require construction of a coffer dam, low water crossing, or other activity that will disturb soil within a water body.

### 3.14.2 Applications

Turbidity barriers are used on development projects that have a perennial water body within or adjacent to the development. The barrier floats in the water and is anchored at the bottom and/or sides depending on the site conditions. Where construction activities extend down a bank of the water body into the water surface, it is installed along the length of disturbed area and functions as a down slope perimeter control.

The barriers are also used where linear projects cross a water body, development extends into a water body, or temporary coffer dams are installed to facilitate construction. In these applications, the turbidity barrier functions as a sediment trap for soil suspended in the water body by construction activities.

Turbidity barriers are most applicable where special aquatic sites or sensitive receiving waters need to be protected. Examples of these types of waters included wetlands regulated under Section 404 of the Clean Water Act, spring-fed water bodies, water bodies with a Total Maximum Daily Load, construction sites with an effluent limit, and water bodies with species protected under the Federal Endangered Species Act or the State of Texas Threatened and Endangered Species Regulations.

### 3.14.3 Design Criteria

- Specific design information is required for the use of this control. The designer shall specify the manufacturer, type of turbidity barrier, length, and anchoring mechanism based on the site conditions, range of depths and velocities in the water body, and project duration.
- The type of turbidity barrier must be specified in accordance with the manufacturer's guidance for the depth of water, salinity, velocities, wave height, and project duration.
- If the barrier will be used to contain contaminants in addition to sediment, ensure the barrier's material is compatible with the contaminant of concern.
- Fabrics used to construct the curtain shall be woven and coated for UV protection.
- Fabric minimum grab tensile strength shall be 202 pounds using ASTM D4632 Test Method for Grab Breaking Load and Elongation of Geotextiles for velocities of 0.5 feet per second or less. Higher velocities require an engineer's design, typically provided by the manufacturer.
- The height of the barrier shall be 10 percent greater than the design water depth to ensure the bottom of the barrier rests on the ground.
- The physical length of the barrier as purchased from the manufacturer shall be 10 to 20 percent longer than the design length to reduce stress on the barrier and make installation easier.
- Panel lengths shall be a maximum of 100 feet in water less than 13 feet and 50 feet in water of 13 feet or deeper.
- Minimize the area to be enclosed by the barrier.
- Provide a means to remove captured trash and sediment from behind the turbidity barrier before the barrier is removed, unless the potential for re-suspending the sediment is greater than the benefit of removing it. Removed sediment will be saturated with water. If possible, reserve a space onsite for the sediment to be spread for drying. Otherwise, provide water-tight containers and disposal procedures for the wet sediment.
- Sediment-laden water may be removed from behind the barrier using dewatering procedures discussed in [Section 3.3 Dewatering Controls](#).

- Barriers shall be designed at a slant to the direction of flow to decrease pressure on the curtain. Barriers should not be installed perpendicular to flow.
- On large lakes where reversing currents may exist, design the barrier to be anchored on both sides of the curtain.
- On lakes or other bodies of water that may have boat traffic, install a buoy marker on any anchors or anchor lines that extend into the water beyond the visible surface of the turbidity barrier.

### *3.14.4 Design Guidance and Specifications*

No specification for construction of turbidity barriers is currently available in the Standard Specifications for Public Works Construction – North Central Texas Council of Governments.

### *3.14.5 Inspection and Maintenance Requirements*

The turbidity barrier should be inspected regularly (at least as often as required by the TPDES Construction General Permit) for movement or dislodgement of the barrier. Verify that all floats are intact and that anchors are secure. The entire top edge should be visible above the water surface. Re-anchor or re-enforce the anchors if the barrier has moved.

Check for debris that may have floated into the barrier and damaged it. Also look for and remove debris caught in the fabric or sediment collected in pockets of the fabric. The fabric should be free of tears and gaps. Repair and replace fabric where damage has occurred.

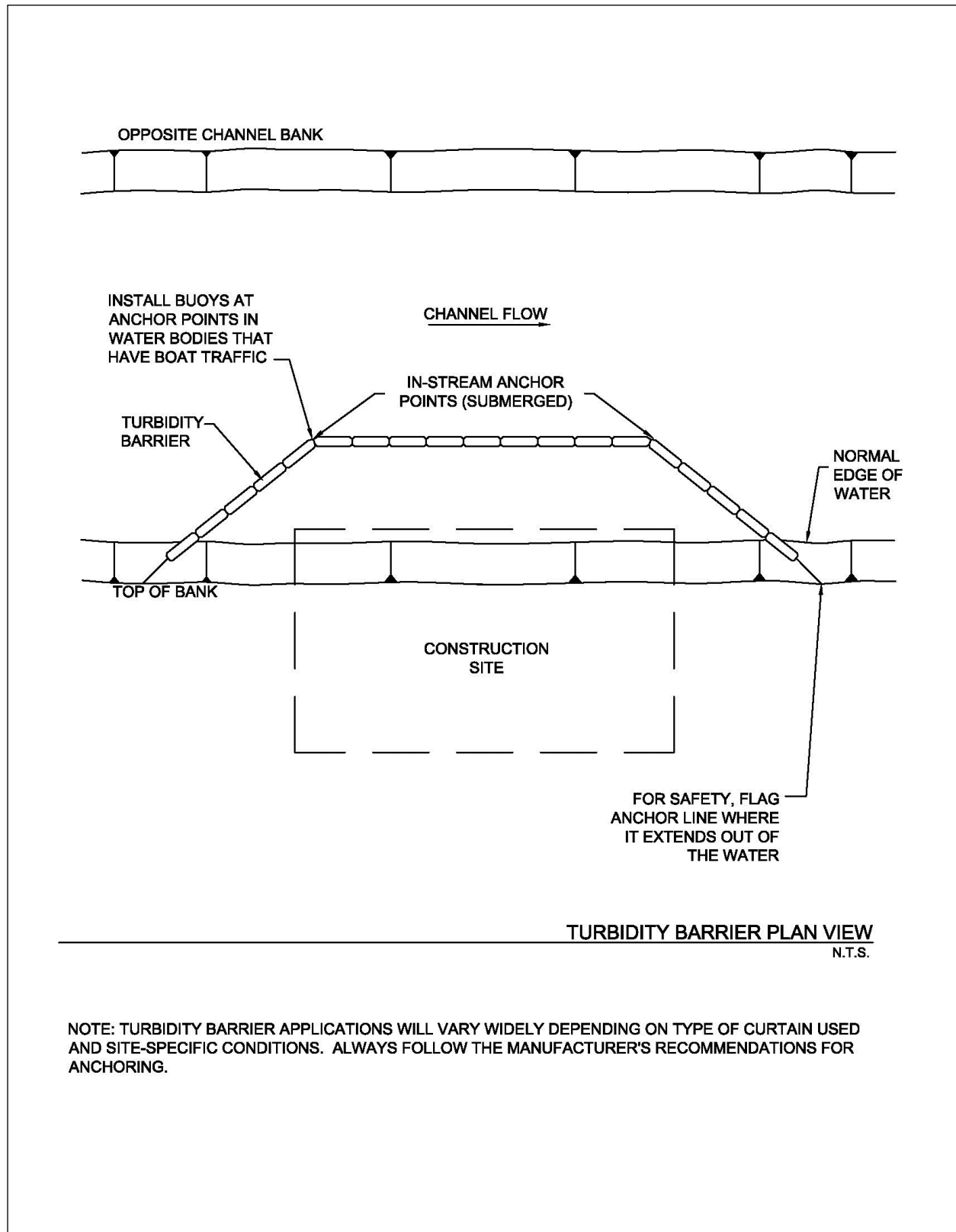
Ensure panel connections are secure and in good condition. Repair any tears in the fabric at the connection points.

Remove sediment from folds and pleats in the barrier when there is evidence of the barrier being pulled down by the weight of the sediment. All sediment accumulated behind the barrier shall be removed from the water before the barrier is removed.

### *3.14.6 Example Schematics*

The following schematics are example applications of the construction control. They are intended to assist in understanding the control's design and function.

The schematics are **not for construction**. They may serve as a starting point for creating a construction detail, but they must be site adapted by the designer. In addition, dimensions and notes appropriate for the application must be added by the designer.



**Figure 3.33 Example Application of Turbidity Barrier**

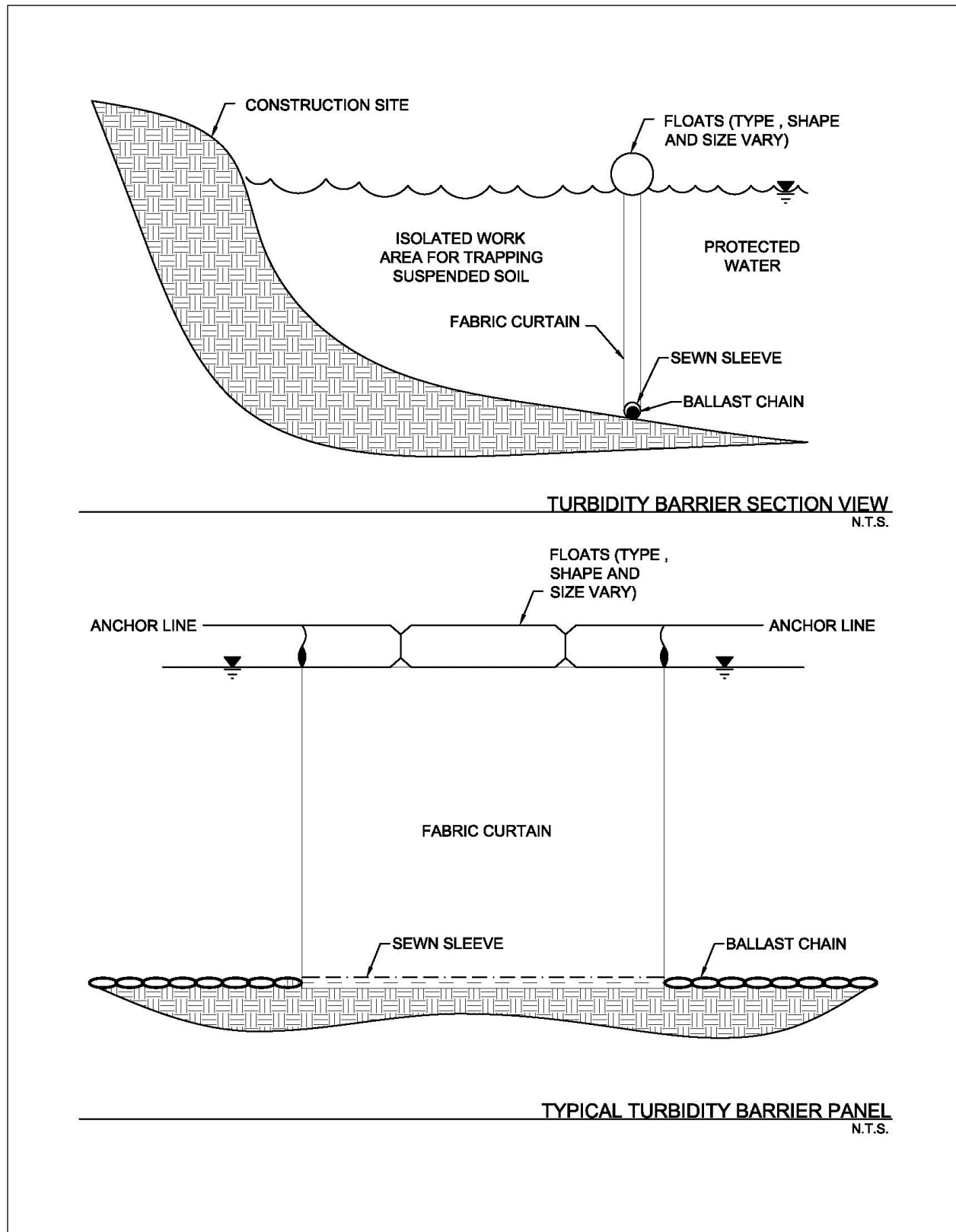
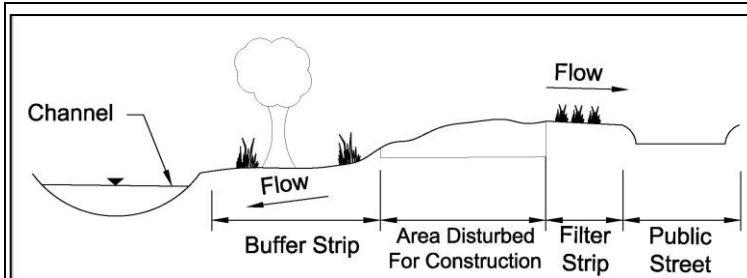


Figure 3.34 Schematics of Turbidity Barrier



### 3.15 Vegetated Filter Strips and Buffers

Sediment Control



**Description:** Buffer strips (existing vegetation) and filter strips (planted vegetation) are sections of vegetated land adjacent to disturbed areas. They are designed with low slopes to convey sheet flow runoff from disturbed areas, resulting in the removal of sediment and other pollutants as the runoff passes through vegetation and infiltration occurs.

**KEY CONSIDERATIONS**

**DESIGN CRITERIA:**

- Minimum width (direction of flow across the vegetation) dependent on slope of disturbed area
- Maximum ratio of disturbed area to vegetated area dependent on slope
- Existing vegetation must meet criteria for type and coverage
- Dense grass required for planted vegetation
- Demarcate limits of vegetation and protect from traffic

**ADVANTAGES / BENEFITS:**

- Effective secondary control for removing clay particles
- Disperses flow and slows velocities to decrease erosion potential in receiving water
- Preserves the character of existing riparian corridor
- May become part of the permanent stormwater controls

**DISADVANTAGES / LIMITATIONS:**

- Appropriate as a primary control only for drainage areas of 2 acres or less and under certain site conditions
- Maximum 150 feet of flow to vegetated strip or buffer is used as a primary control
- Cannot treat large volumes or concentrated flows
- Not effective as a perimeter control when the perimeter cuts across contours instead of following contours
- Must limit access to vegetated portion of the site

**MAINTENANCE REQUIREMENTS:**

- Inspect regularly
- Rake accumulations of sediment from the vegetation
- Repair bare areas

**TARGETED POLLUTANTS**

- Sediment
- Nutrients & Toxic Materials
- Oil & Grease
- Floatable Materials
- Other Construction Wastes

**APPLICATIONS**

Perimeter Control
Slope Protection
Sediment Barrier

- Channel Protection
- Temporary Stabilization
- Final Stabilization
- Waste Management
- Housekeeping Practices

**Fe=0.35-0.85**

*(Depends on many conditions in addition to soil type)*

**IMPLEMENTATION CONSIDERATIONS**

- Capital Costs
- Maintenance
- Training
- Suitability for Slopes > 5%

**Other Considerations:**

- *Coordination with final landscaping*

### 3.15.1 Primary Use

Vegetated filter strips and buffers are used to reduce the velocity of sheet flow and reduce the volume of runoff through infiltration. In the process, sediment is removed as the runoff is filtered through the vegetation and infiltration occurs.

Vegetated filter strips and buffers are frequently used a secondary sediment control, since their performance is highly variable. They may be used as a primary sediment control only for small areas and under select site conditions.

### 3.15.2 Applications

Vegetated buffers are most applicable on development projects that are adjacent or near to floodplains, wetlands, streams and other natural waterways. Vegetated strips may be established along roads and property lines as a perimeter control for development. They are also applicable along the down slope side of utility line projects.

Vegetated buffers may be a primary sediment control for small areas where the conditions meet design criteria. They are also commonly used as a secondary control with other perimeter controls to provide higher levels of sediment removal. Vegetated areas have more capability to remove fine particle sizes than many conventional sediment controls. Combinations such as an organic filter tube or silt fence at the upslope edge of a vegetated strip are very effective.

In addition to perimeter control, vegetated strips are applicable for slope protection. Strips may be established at regular intervals to interrupt long or steep slopes. The strips maintain sheet flow, decrease velocities, and decrease erosion on the slopes.

### 3.15.3 Design Criteria

Vegetated buffers should be preserved along existing floodplains, wetlands, channels, and other natural waters whenever possible, even when the buffer is not a primary sediment control. Check for local requirements, as many municipalities mandate a vegetated buffer to maintain the character of the riparian corridor along a natural waterway. Vegetated buffers are encouraged to protect existing waterways by decreasing velocities, dispersing flow, and attenuating volume before the runoff reaches the waterway. If the development plans necessitate disturbing the riparian corridor, phase the development (when possible) to retain a vegetated buffer until final grading and landscaping at the end construction.

The evaluation and use of vegetated strips and buffers for use as a sediment control are unique to each site. The designer should carefully consider slope, vegetation, soils, depth to impermeable layer, depth to ground water, and runoff sediment characteristics before specifying a vegetated strip or buffer as a primary sediment control. This consideration is especially true for buffer strips of existing vegetation. If the buffer is not correctly planned, the first storm event can damage the natural vegetation beyond repair.

Design criteria in this section are only applicable when a vegetated strip or buffer is intended to be a primary or secondary sediment control for the construction site. As discussed above, a vegetated buffer may be preserved for other reasons that do not necessitate the use of these criteria if other sediment controls are provided for the construction site.

#### General

- Maximum slope of the vegetated strip or buffer shall be 5% across the width of the vegetation in the direction of flow.
- To maintain sheet flow, maximum distance of flow to the vegetated filter shall be 150 feet.
- Vegetated buffers and strips may only serve as a primary sediment control when the contributing drainage area has a slope of 15% or less. On steeper slopes, another perimeter control (e.g. organic filter tube, silt fence) may be installed at the upslope edge of the vegetated buffer or strip as a primary control, with the vegetation serving as a secondary control.

- Maximum disturbed area contributing runoff to the vegetated strip or buffer shall be 2 acres.
- Vegetated filter strips and buffers shall be a minimum of 15 feet wide. Width shall be increased based on the slope of the disturbed area as shown in the following table. Although the slope of the disturbed area may be up to 15%, the slope of the vegetated strip or buffer is still limited to 5% maximum if used as a primary control for sediment.

<b>Maximum Slope of Contributing Drainage Area</b>	<b>Maximum Ratio of Disturbed Area to Vegetated Area</b>	<b>Minimum Width of Vegetated Area (Direction of Flow)</b>
5%	8:1	15 feet
10%	5:1	30 feet
15%	3:1	50 feet

- Access to vegetated buffers and strips shall be prohibited. These areas shall be protected from all traffic. No activities should occur in these areas, including no parking of the workers' vehicles, no eating of lunch, etc.
- Install controlled and stabilized ingress/egress points to manage traffic and direct it away from vegetation. Fence the vegetation or provide other means of protection to prevent vehicles and equipment from driving on the vegetated areas.
- Vegetated buffers and filter strips should not be used when high ground water, shallow depth to bedrock, or low soil permeability will inhibit infiltration of runoff.

### **Buffers of Existing Vegetation**

- Fencing, flagged stakes spaced at a maximum of 6 feet, or other measures shall be used to clearly mark existing vegetation that is being preserved as a buffer before the start of any clearing, grubbing, or grading.
- Existing vegetation must be well established to be used as a vegetated buffer. It may be a mix of trees, sapling/shrubs, vines and herbaceous plants. However, the herbaceous plants shall cover at least 80 percent of the ground area.
- Bare soil shall not be visible within the buffer. Area between herbaceous plants shall be covered with a natural litter of organic matter (e.g. leaves, dead grass).
- Lots with a thick stand of existing grasses may preserve strips of the grasses as perimeter control in addition to using vegetation as a buffer along a natural waterway.

### **Strips of Planted Vegetation**

- Vegetated strips should only be used when the site perimeter is along (parallel to) contours. Erosion of the vegetated strip will be a problem when the strip is placed along roads or site perimeters that cut across contours, resulting in runoff flowing along, instead of across, the filter strip.
- Minimize vehicle and equipment traffic and other activities that could compact soils on areas that will be planted for vegetated strips.
- Sod is required when the strip is intended to immediately function as a sediment control.
- Erosion control blankets (ECBs) should be used to prevent erosion and provide sediment control while establishing vegetation for a filter strip. If ECBs are not used, then another perimeter control is required until the vegetation is mature. Refer to [Section 2.3 Erosion Control Blankets](#).
- Refer to the [Section 2.9 Vegetation](#) for criteria on establishing vegetation.
- When using vegetated strips for slope protection, spacing of the strips should be designed based on

slope steepness and type of soil. The strips may be planted directly on the slope grade when the slope is flatter than 2:1. For slopes of 2:1 and steeper, vegetation should be established on terraces. Terraces shall have a transverse slope of 1 percent in the opposite direction of the slope (i.e. back into the ground).

### 3.15.4 *Design Guidance and Specifications*

Guidance for analysis of the hydraulic loading on filter strips is in *Section 13.3 of the Stormwater Controls Technical Manual*.

No specification for vegetated filter strips and buffers is currently available in the Standard Specifications for Public Works Construction – North Central Texas Council of Governments.

### 3.15.5 *Inspection and Maintenance Requirements*

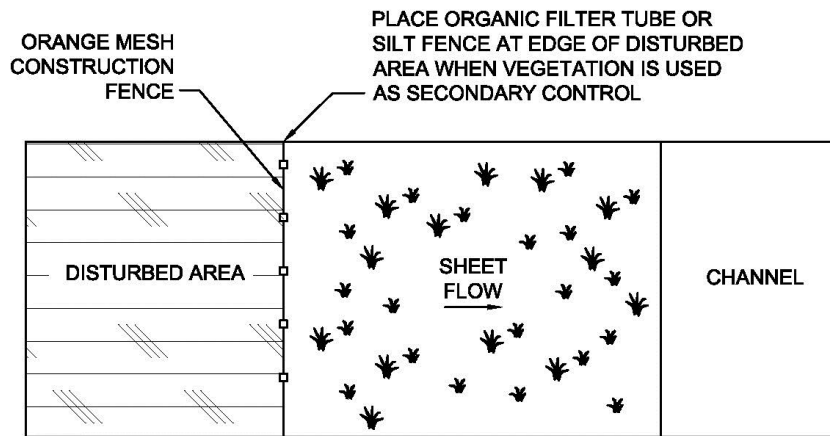
Vegetated filter strips and buffers should be inspected regularly (at least as often as required by the TPDES Construction General Permit). If rill erosion is developing, additional controls are needed to spread the flow before it enters the vegetated area. Rake light accumulations of sediment from the vegetation. Remove trash that accumulates in the vegetation. Additional sediment controls (e.g. a line of organic filter tubes or silt fence), are needed if sediment accumulations are large enough to bury the vegetation.

Inspect established planted vegetation for bare areas and place sod or install seeded erosion control blankets, as appropriate. Mow as needed after planted vegetation is mature.

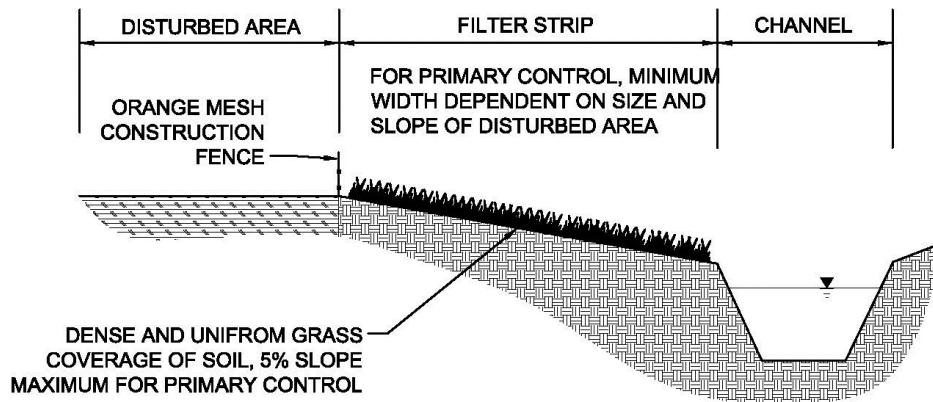
### 3.15.6 *Example Schematics*

The following schematics are example applications of the construction control. They are intended to assist in understanding the control's design and function.

The schematics are **not for construction**. They may serve as a starting point for creating a construction detail, but they must be site adapted by the designer. In addition, dimensions and notes appropriate for the application must be added by the designer.



**VEGETATED FILTER STRIP PLAN VIEW**  
N.T.S.

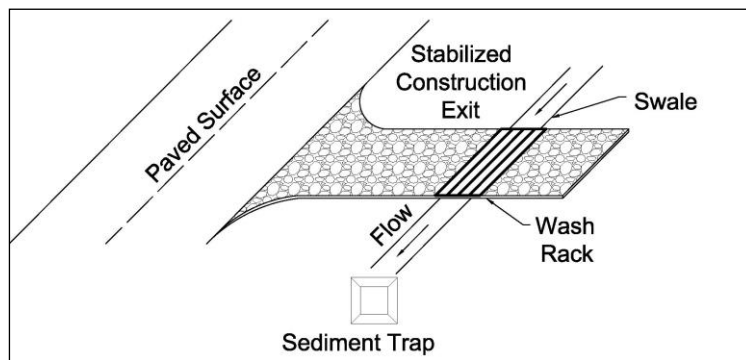


**VEGETATED FILTER STRIP PROFILE VIEW**  
N.T.S.

**Figure 3.35 Schematics of Vegetated Filter Strip**

### 3.16 Wheel Cleaning Systems

Sediment Control



**Description:** Wheel cleaning systems are used with a stabilized construction exit to remove soil from vehicle wheels and undercarriages prior to leaving the construction site. The cleaning system may be as simple as uneven, steel racks that “rumble” the vehicle or as complex as a pre-manufactured wash bay. Systems that include wash water must provide for collecting the water and removing sediments and other pollutants prior to discharge.

**KEY CONSIDERATIONS**

**DESIGN CRITERIA:**

- Locate within the stabilized construction exit
- Design according to type of soil and the number and size of vehicles using the cleaning system
- Provide a means of collecting wash water and removing sediment before discharge

**ADVANTAGES / BENEFITS:**

- Effectively reduces off-site sediment tracking
- Components of the system may be re-used on different projects

**DISADVANTAGES / LIMITATIONS:**

- Requires separate construction entrances and exits
- Requires frequent cleaning to remain functional
- Effectiveness dependent on operator training
- Sediment trapping controls won't remove oils or other pollutants in the wash water
- Potential overflows and discharges of wash water if sediment controls not carefully designed for the maximum amount of wash water to be generated

**MAINTENANCE REQUIREMENTS:**

- Inspect regularly
- Remove sediment from wheel cleaning device before sediment accumulates to half the depth of the device
- Remove sediment from sediment traps before it reaches a depth of half the design depth or 12 inches, whichever is less
- Dewater and clean wash basins using dewatering controls

**TARGETED POLLUTANTS**

- Sediment
- Nutrients & Toxic Materials
- Oil & Grease
- Floatable Materials
- Other Construction Wastes

**APPLICATIONS**

- Perimeter Control
- Slope Protection
- Sediment Barrier**
- Channel Protection
- Temporary Stabilization
- Final Stabilization
- Waste Management
- Housekeeping Practices

**Fe=N/A**

**IMPLEMENTATION CONSIDERATIONS**

- Capital Costs
- Maintenance
- Training
- Suitability for Slopes > 5%

**Other Considerations:**

- *Management of wash water*
- *Prohibitions on the discharge of soaps and petroleum products*

### 3.16.1 Primary Use

Wheel cleaning systems are used to remove soil from construction vehicles and equipment before they leave the site and enter paved streets. Wheel cleaning systems are used with a stabilized construction exit to minimize the tracking of soil from disturbed areas. They provide added protection and reduce the need to remove sediment from streets.

### 3.16.2 Applications

Wheel cleaning systems can be used on any construction site where a stabilized construction exit is not adequate to prevent off-site tracking of soil. However, because of their cost, they are most applicable for:

- Sites with large areas (> 10 acres) that are disturbed for long periods of time;
- Sites with a large number of vehicles and/or heavy equipment entering and exiting the site, which that will quickly and repeatedly degrade rock exits;
- Sites with clay soils or wet site conditions that result in tires accumulating large amounts of soil; or
- Sites where contaminated soils might be present.

### 3.16.3 Design Criteria

#### General

- Provide separate entrances and exits to the construction site so that incoming vehicles do not drive through the wheel cleaning system. Signage and employee training is critical to making the system work.
- Wheel cleaning systems should be located within the stabilized construction exit so that the vehicle does not pick up additional sediment load by traversing disturbed areas. A minimum of 25 feet of stabilized exit shall be maintained between the cleaning system and the paved road.
- The stabilized exit shall be sloped at 1 percent toward the cleaning system.
- The width of the stabilized exit may be reduced to 10 to 20 feet, depending on the size and number of vehicles using the exit, as long as all exiting traffic is funneled through the cleaning system.
- Post a sign requiring all vehicles to use the cleaning system before leaving the site. Posted speed limit through the wheel cleaning system should be 5 mph.
- Wheel cleaning systems should be designed with ease of access to areas where sediment will accumulate, so the system can be frequently cleaned.

#### Rumble Racks

- The minimum cleaning system shall consist of 10 foot wide, 8 foot long, steel grates with individual bars of the grates at varying heights to shake the vehicle and knock off soil. These grates are also known as rumble racks.
- Minimum length of the rumble rack shall be the length of the circumference of the largest tire on vehicles that will be using the construction exit. Two to three lengths of grates are typically necessary to provide adequate soil removal, depending on soil type and size of vehicles.
- Grates shall be placed over an excavated pit that is a minimum of one foot deep.
- Grates may be purchased pre-made from vendors or constructed by welding 10 foot lengths of structural steel tubing (rectangular section) or angle. The lengths of steel ("bars" of the rumble rack) should be welded to steel beams or other cross supports in a manner that provides for alternating heights. This is accomplished with rectangular steel tube by alternating the long and short sides of

the tube upward. Angle iron, welded to the support structure with the angle pointed upward, may also be used. Round tubing shall not be used, as it does not adequately shake the tires.

- Size and spacing of bars and support beams shall be designed based on the size and weight of vehicles expected to be using the rumble rack.
- Welded or manufactured grates may be cleaned and re-used on multiple projects.

## Wheel Washes

- Two common types of wheel wash systems constructed onsite are the corrugated metal wheel wash and the flooded basin wheel wash. In addition, several companies manufacture packaged wash systems that can be assembled onsite and re-used. All of these require a source of water, and several of the packaged systems require electricity to run pumps for water pressure.
- All wheel washes must provide a means to collect the wash water in a sediment basin or other sediment control that provides equivalent or better treatment prior to discharge from the site.
- For the flooded basin wheel wash, sedimentation occurs in the wash basin, meaning the basin cannot be used for a period of time while settling is allowed to occur. Cleaning of the basin should be done first thing in the morning after particles have settled overnight, and ideally the basin would be cleaned on Monday after settling all weekend. If the basin is pumped for cleaning, it should be accomplished using the controls in [Section 3.3 Dewatering Controls](#).
- Corrugated metal wheel washes shall be constructed over a drainage swale that conveys the wash water to a sediment barrier, typically a sediment basin. However, a passive or active treatment system may be needed to adequately remove suspended solids depending on the permit requirements for the site.
- Swales, sediment basins, stone outlet sediment traps, and other controls for the wash water must be sized for the anticipated flows from the wheel wash using criteria in their respective sections of this manual. Depending on the volume of water, two sediment controls may be needed in parallel, to allow for settling and cleaning of one sediment control while the other is in operation for the wheel wash.
- Manufactured wash systems frequently collect, filter, and recycle the wash water, resulting in the use of less water and producing less wash water to treat for sediment removal. For this reason, they may be more cost-effective over the life of the project, even if their initial cost is higher.
- If a packaged wheel wash system does not include a sediment collection area, then a swale and sediment trap is required, similar to the corrugated metal wheel wash.
- Prohibit the use of soap for wheel washing. The purpose of a wheel wash is to remove soil that would otherwise fall off on the roadway, not to clean the vehicle. Refer to [Section 4.10 Vehicle and Equipment Management](#) for proper vehicle washing procedures. The discharge of wash water with soap in it is prohibited, and soap is not removed by a sediment control.
- Train employees to only use water in the wheel wash for removing accumulations of soil from the wheels and undercarriage. Minimize water contact with other portions of the vehicle or equipment. Wash water contaminated with oil, grease or fuel requires special handling and disposal. Refer to [Section 4.10 Vehicle and Equipment Management](#).

### 3.16.4 Design Guidance and Specifications

No specification for construction of this item is currently available in the Standard Specifications for Public Works Construction – North Central Texas Council of Governments.



### 3.16.5 *Inspection and Maintenance Requirements*

Wheel cleaning systems should be inspected regularly (at least as often as required by the TPDES Construction General Permit). Systems should be cleaned frequently, at least weekly and sometimes daily, to ensure proper operation. Grated systems should be cleaned before sediment accumulates to half the depth of the pit below the grates. Depending on volume of traffic, flooded basin systems often needed daily pumping, cleaning and refilling to be effective.

The sediment basin or other sediment trapping device shall be inspected for damaged areas and repaired as necessary. Sediment that has accumulated in the wash water sediment control (must be removed before it reaches half the design depth of the device or 12 inches, whichever is less. The removed sediment shall be stockpiled or redistributed to areas of the site that are protected by erosion and sediment controls.

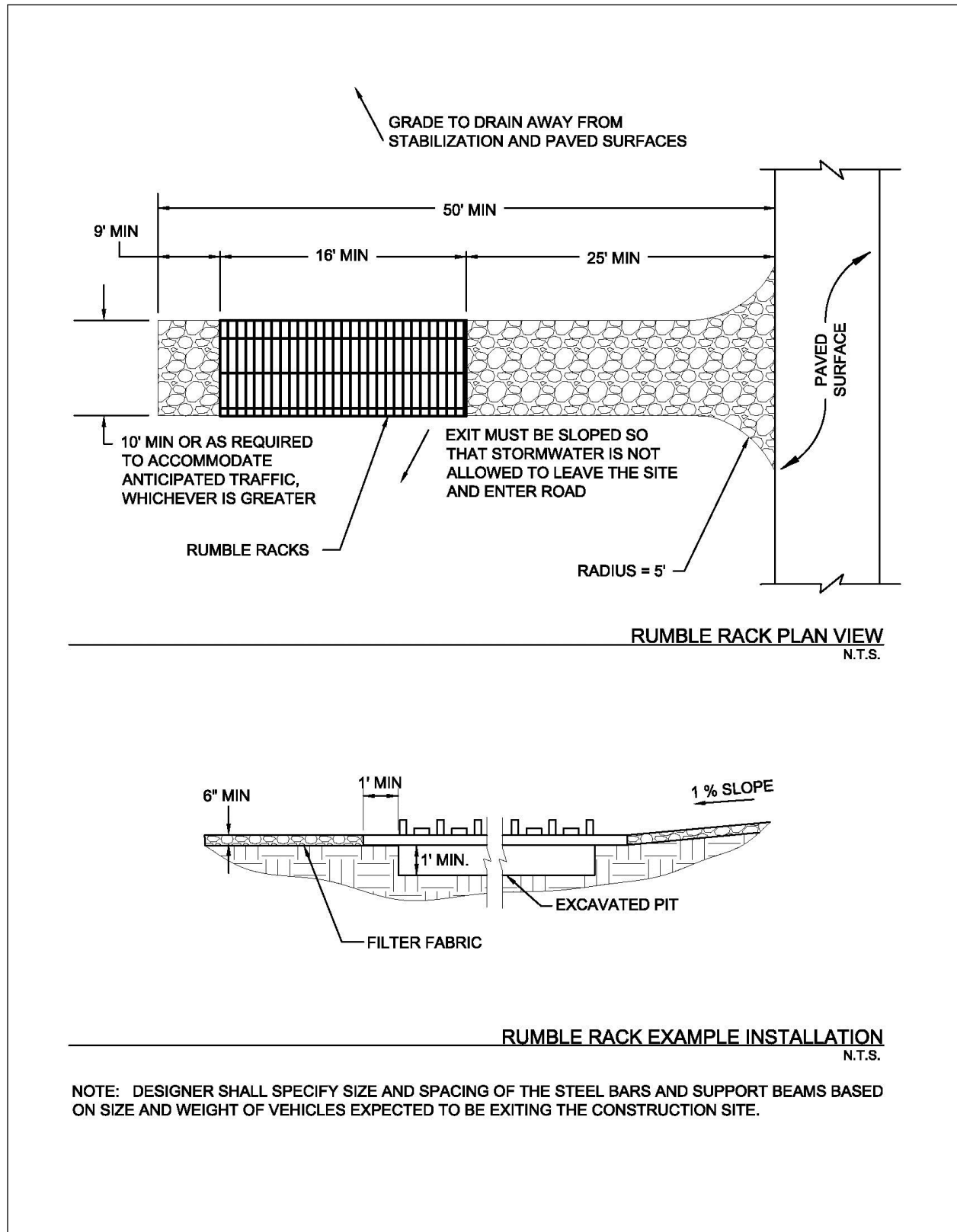
Water that ponds in the sediment basin should be inspected for sheen. If sheen is present, the water is considered contaminated by a petroleum product. Regulations of the TCEQ require this water to be pumped into containers and disposed of appropriately. It is not an authorized discharge from the construction site. Proper vehicle and equipment maintenance is essential to preventing this problem from occurring.

Manufacturer's recommendations should be followed for cleaning and maintaining packaged wheel wash systems.

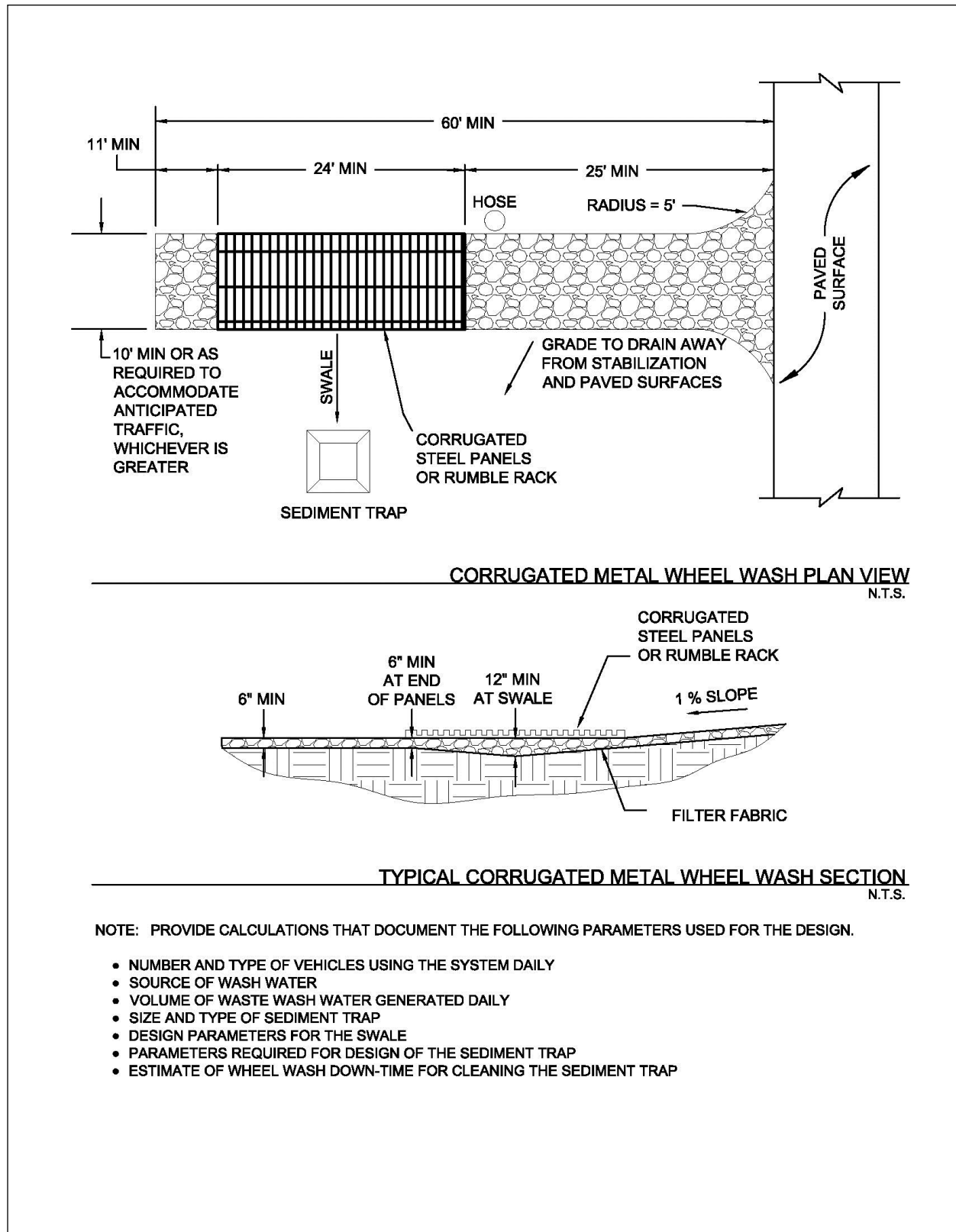
### 3.16.6 *Example Schematics*

The following schematics are example applications of the construction control. They are intended to assist in understanding the control's design and function.

The schematics are **not for construction**. They may serve as a starting point for creating a construction detail, but they must be site adapted by the designer. In addition, dimensions and notes appropriate for the application must be added by the designer.

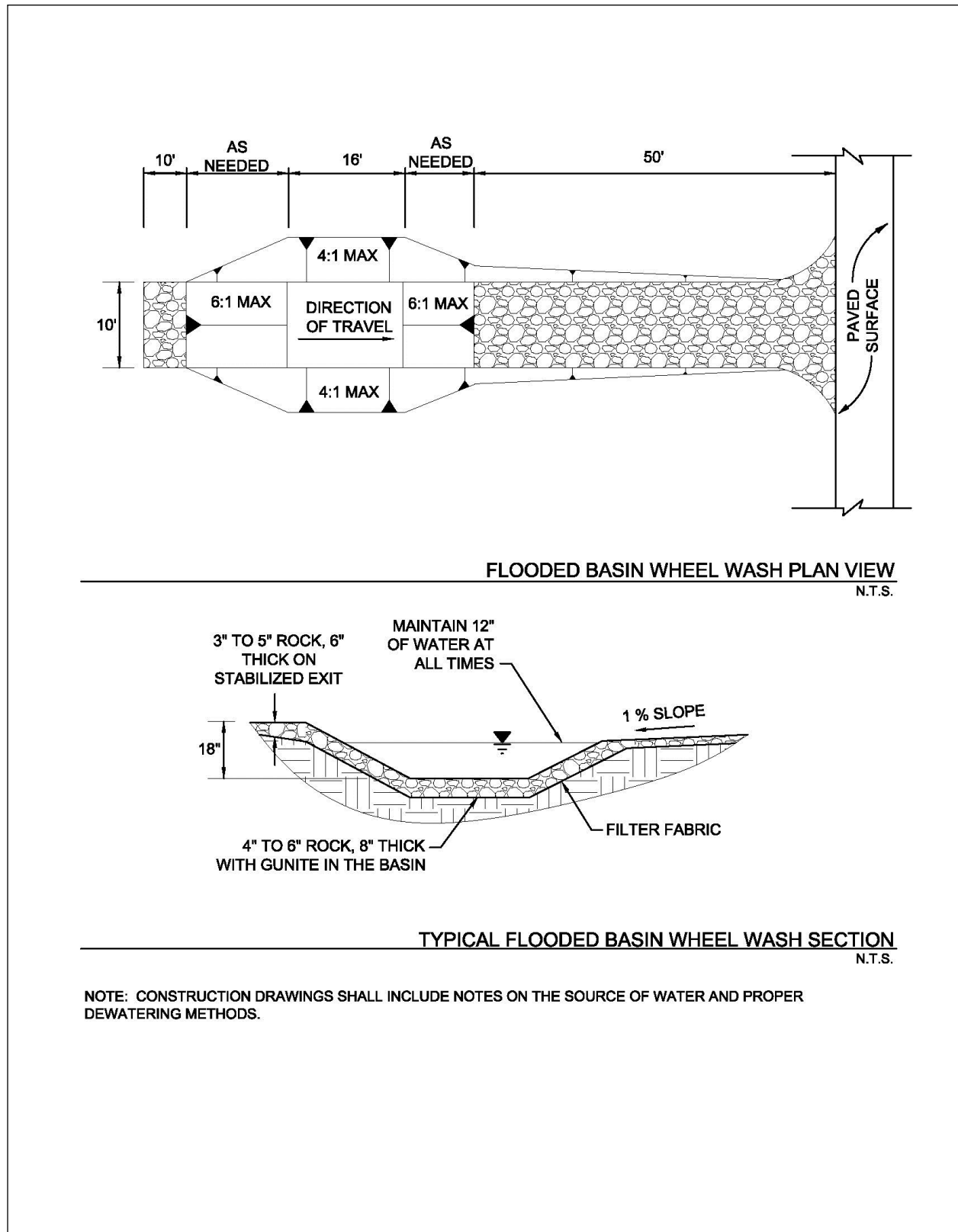


**Figure 3.36 Schematics of Rumble Rack Wheel Cleaning**



**Figure 3.37 Schematics of Corrugated Metal Wheel Wash**

(Source: Modified from California Stormwater Quality Association BMP Handbook BMP Detail TC-1)



**Figure 3.38 Schematics of Flooded Basin Wheel Wash**

(Source: Modified from Oregon Department of Environmental Quality Erosion and Control Sediment Manual Detail SC-11)

# 4.0 Material and Waste Controls

## 4.1 Chemical Management

**Material and Waste Control**

**Description:** Chemical management addresses the potential for stormwater to be polluted with chemical materials and wastes that are used or stored on a construction site. The objective of chemical management is to minimize the potential of stormwater contamination by construction chemicals through appropriate recognition, handling, storage, and disposal practices.

<p style="text-align: center;"><b><u>KEY CONSIDERATIONS</u></b></p> <p><b>DESIGN CRITERIA:</b></p> <ul style="list-style-type: none"> <li>• Designate a person responsible for chemical management</li> <li>• Minimize the amount of chemicals and waste stored onsite</li> <li>• Provide secondary containment that's 110 percent of the largest container in the containment</li> <li>• Label all containers</li> <li>• Prohibit the discharge of washout water</li> <li>• Train workers in proper procedures</li> <li>• Provide timely removal of waste materials</li> </ul> <p><b>LIMITATIONS:</b></p> <ul style="list-style-type: none"> <li>• Not intended to address site-assessment and pre-existing contamination</li> <li>• Does not address demolition activities and potential pre-existing materials, such as lead and asbestos</li> <li>• Does not address contaminated soils</li> <li>• Does not address spill and leak response procedures</li> <li>• Does not address chemicals associated with vehicle and equipment management</li> </ul> <p><b>MAINTENANCE REQUIREMENTS:</b></p> <ul style="list-style-type: none"> <li>• Inspect regularly</li> <li>• Check for proper storage and evidence of leaks and spills</li> <li>• Make sure all containers are labeled</li> <li>• Check waste containers and dispose of the waste when 90 percent full</li> <li>• Verify procedures are being followed</li> <li>• Train new employees and regularly re-train all employees</li> </ul>	<p style="text-align: center;"><b><u>APPLICATIONS</u></b></p> <p><b>Perimeter Control</b></p> <p><b>Slope Protection</b></p> <p><b>Sediment Barrier</b></p> <p><b>Channel Protection</b></p> <p><b>Temporary Stabilization</b></p> <p><b>Final Stabilization</b></p> <div style="border: 1px solid black; padding: 2px; margin: 2px;"> <p><b>Waste Management</b></p> </div> <div style="border: 1px solid black; padding: 2px; margin: 2px;"> <p><b>Housekeeping Practices</b></p> </div>
<p style="text-align: center;"><b><u>TARGETED POLLUTANTS</u></b></p> <ul style="list-style-type: none"> <li><input type="radio"/> Sediment</li> <li><input checked="" type="radio"/> Nutrients &amp; Toxic Materials</li> <li><input checked="" type="radio"/> Oil &amp; Grease</li> <li><input type="radio"/> Floatable Materials</li> <li><input checked="" type="radio"/> Other Construction Wastes</li> </ul>	<p style="text-align: center;"><b><u>IMPLEMENTATION CONSIDERATIONS</u></b></p> <ul style="list-style-type: none"> <li><input type="radio"/> Capital Costs</li> <li><input type="radio"/> Maintenance</li> <li><input checked="" type="radio"/> Training</li> <li><input type="radio"/> Suitability for Slopes &gt; 5%</li> </ul> <p><b>Other Considerations:</b></p> <ul style="list-style-type: none"> <li>• <i>TCEQ regulations for hazardous waste</i></li> </ul>

### 4.1.1 Primary Use

These management practices, along with applicable OSHA, EPA, and TCEQ requirements, are implemented at construction sites to prevent chemicals, hazardous materials, and their wastes from becoming stormwater pollutants.

### 4.1.2 Applications

Chemical management is applicable on all construction sites where chemicals and hazardous materials are stored or used and could result in pollutants being discharged with stormwater. Many chemicals, such as paints, grease, concrete curing compounds, and pesticide are present at most construction sites. Chemical management is most effective when used in conjunction with controls in [Section 4.8 Spill and Leak Response Procedures](#).

Management of vehicle and equipment maintenance chemicals is applicable to all construction activities. These chemicals are the most common ones on construction sites; plus, there are specific stormwater permit requirements for vehicle and equipment maintenance. For these reasons, the management of chemicals associated with vehicles and equipment are found in [Section 4.10 Vehicle and Equipment Maintenance](#).

Chemical management techniques are based on proper recognition, handling, and disposal practices by construction workers and supervisors. Key elements are education and modification of workers' behavior and provisions for safe storage and disposal. Cooperation and vigilance is required on the part of supervisors and workers to ensure that the procedures are followed.

The following list (not all inclusive) gives examples of targeted chemicals:

- Paints
- Solvents
- Stains
- Wood preservatives
- Cutting oils
- Greases
- Roofing tar
- Pesticides, herbicides, & fertilizers
- Concrete curing compound

It is not the intent of chemical management to supersede or replace normal site assessment and remediation procedures. Significant spills and/or contamination warrant immediate response by trained professionals. Chemical management shall be applied in combination with criteria in [Section 4.8 Spill and Leak Response Procedures](#).

### 4.1.3 Design Criteria

- Construction plan notes shall require controls for all chemicals, hazardous materials, and their wastes that are potentially exposed to precipitation or stormwater runoff.
- Show the location of chemical and hazardous waste storage and secondary containment on the drawings, or require the contractor to add this information.
- The contractor should be required to designate a site superintendent, foreman, safety officer, or other senior person who is onsite daily to be responsible for implementing chemical management.
- Specify use of the least hazardous chemical to perform a task when alternatives are available. To the extent possible, do not use chemicals that are classified as hazardous materials or that will generate

a hazardous waste. A hazardous material is any compound, mixture, solution, or substance containing a chemical listed on the EPA's *Consolidated List of Chemicals Subject to the Emergency Planning and Community Right-to-Know Act (EPCRA) and Section 112(r) of the Clean Air Act* (EPA 550-B-01-003, October 2001), available at:

<http://www.epa.gov/ceppo/pubs/title3.pdf>

## Chemical and Hazardous Material Storage

- As much as possible, minimize the exposure of building materials, building products, landscape materials, fertilizers, pesticides, herbicides, detergents, and other materials to precipitation and stormwater runoff.
- Chemicals and hazardous materials shall be stored in their original, manufacturers' containers, inside a shelter that prevents contact with rainfall and runoff.
- The amount of chemicals and hazardous materials stored onsite shall be minimized and limited to the materials necessary for the current phase of construction.
- Material Safety and Data Sheets (MSDSs) shall be available for all chemicals used or stored onsite.
- Chemical and hazardous materials shall be stored a minimum of 50 feet away from inlets, swales, drainage ways, channels, and other waters, if the site configuration provides sufficient space to do so. In no case shall material and waste sources be closer than 20 feet from inlets, swales, drainage ways, channels, and other waters.
- Use secondary containment controls for all hazardous materials. Containment shall be a minimum size of 110 percent of the largest chemical container stored within the containment.
- If an earthen pit or berm is used for secondary containment, it shall be lined with plastic or other material that is compatible with the chemical being stored.
- Chemical and hazardous material storage shall be in accordance with Federal and State of Texas regulations and with the municipality's fire codes.
- Storage locations shall have appropriate placards for emergency responders.
- Containers shall be kept closed except when materials are added or removed.
- Chemicals shall be dispensed using drip pans or within a lined, bermed area or using other spill/overflow protection measures.

## Washout Procedures

- Many chemicals (e.g. stucco, paint, form release oils, curing compounds) used during construction may require washing of applicators or containers after use. The discharge of this wash water is prohibited.
- Wash water shall be collected in containers, labeled, and classified for correct waste disposal.
- A licensed waste hauler shall be used for wash water.

## Chemical and Hazardous Waste Handling

- Ensure that adequate waste storage volume is available.
- Ensure that waste collection containers are conveniently located and compatible with the waste chemicals.
- Waste containers shall have lids and be emptied or hauled for disposal when they are 90 percent full or more frequently.
- Segregate potentially hazardous waste from non-hazardous construction waste and debris.

- Do not mix different chemical wastes. First, dangerous reactions may result. Second, all of the waste will be classified as the most hazardous waste in the container and will increase disposal costs.
- Clearly label all chemical and hazardous waste containers to identify which wastes are to be placed in each container.
- Based on information in the Material Safety Data Sheet, ensure that proper spill containment material is available onsite and maintained near the storage area.
- Do not allow potentially hazardous waste to be stored on the site for more than 90 days.
- Enforce hazardous waste handling and disposal procedures.

## Disposal Procedures

- Regularly schedule waste removal to minimize onsite storage.
- Use only licensed waste haulers.
- For special and hazardous wastes, use licensed hazardous waste transporter that can classify, manifest and transport the special or hazardous wastes for disposal.
- Where possible, send wastes such as used oil to a recycler instead of a disposal facility.
- No chemical waste shall be buried, burned or otherwise disposed of onsite.

## Education

- Instruct workers on safe chemical storage and disposal procedures.
- Instruct workers in identification of chemical pollutants and proper methods to contain them during storage and use.
- Educate workers of potential dangers to humans and the environment from chemical pollutants.
- Educate all workers on chemical storage and disposal procedures.
- Have regular meetings to discuss and reinforce identification, handling and disposal procedures (incorporate in regular safety seminars).
- Establish a program to train new employees.

## Quality Control

- Designated personnel shall monitor onsite chemical storage, use, and disposal procedures.
- Educate and if necessary, discipline workers who violate procedures.
- Retain trip reports and manifests that document the recycling or disposal location for all chemical, special, and hazardous wastes that all hauled from the site.

### 4.1.4 *Design Guidance and Specifications*

National guidance for response procedures are established by the Environmental Protection Agency (EPA) in the Code of Federal Regulations (CFR). Specific sections addressing spills are governed by:

- 40 CFR Part 261 Identification and Listing of Hazardous Waste.
- 40 CFR Part 262 Standards Applicable to Generators of Hazardous Waste.
- 40 CFR Part 263 Standards Applicable to Transporters of Hazardous Waste.
- 49 CFR Parts 171-178 of the Transportation Hazardous Materials Regulations.



Guidance for storing, labeling, and managing hazardous waste in the State of Texas are established by the Texas Commission on Environmental Quality (TCEQ) in the Texas Administrative Code Title 30, Chapter 335, Industrial Solid Waste and Municipal Hazardous Waste.

No specification for chemical management measures is currently available in the Standard Specifications for Public Works Construction – North Central Texas Council of Governments.

#### *4.1.5 Inspection and Maintenance Requirements*

Chemical management measures should be inspected regularly (at least as often as required by the TPDES Construction General Permit) for proper storage and evidence of leaks or spills. Check that all chemicals, hazardous materials, and wastes are properly stored and labeled. If not stored properly, take corrective action, and reinforce procedures through re-education of employees.

If leaks or spills have occurred, check that proper clean up and reporting procedures have been followed. If procedures have not been followed, take corrective action. Check that all employees have been trained in spill and leak procedures as detailed in [Section 4.8 Spill and Leak Response Procedure](#).

## 4.2 Concrete Sawcutting Waste Management

Waste Control

**Description:** Sawcutting of concrete pavement is a routine practice used to control shrinkage cracking immediately following placement of plastic concrete. It is also used to remove curb sections and pavement sections for pavement repairs, utility trenches, and driveways. Sawcutting for joints involves sawing a narrow, shallow groove in the concrete, while sawcutting for removals is usually done full depth through the slab. Water is used to control saw blade temperature and to flush the detritus from the sawed groove. The objective of concrete sawcutting waste management is to prevent the resulting slurry of process water and fine particles with its high pH from becoming a water pollutant.

<p style="text-align: center;"><b><u>KEY CONSIDERATIONS</u></b></p> <p><b>DESIGN CRITERIA:</b></p> <ul style="list-style-type: none"> <li>● Prohibit discharge of untreated slurry</li> <li>● Educate employees on proper procedures</li> <li>● Continuously vacuum slurry and cuttings during sawcutting operation</li> <li>● Block inlets to prevent discharges</li> <li>● Establish an onsite containment area (minimum 1 ft freeboard) if immediate disposal of the vacuumed slurry is not feasible</li> <li>● Water evaporation and concrete recycling are the recommended disposal methods when slurry is not vacuumed</li> </ul> <p><b>LIMITATIONS:</b></p> <ul style="list-style-type: none"> <li>● Only one part of concrete waste management</li> <li>● Does not address concrete demolition waste</li> </ul> <p><b>MAINTENANCE REQUIREMENTS:</b></p> <ul style="list-style-type: none"> <li>● Check for uncollected slurry after all sawcutting operations</li> <li>● Inspect collection areas and repair containment as needed</li> <li>● Dispose of sediment and cuttings when collection area volume is reduced by 50 percent</li> <li>● Train new employees and regularly re-train all employees</li> </ul>	<p style="text-align: center;"><b><u>APPLICATIONS</u></b></p> <p><b>Perimeter Control</b></p> <p><b>Slope Protection</b></p> <p><b>Sediment Barrier</b></p> <p><b>Channel Protection</b></p> <p><b>Temporary Stabilization</b></p> <p><b>Final Stabilization</b></p> <div style="border: 1px solid black; padding: 2px; text-align: center;"><b>Waste Management</b></div> <p><b>Housekeeping Practices</b></p>
<p style="text-align: center;"><b><u>TARGETED POLLUTANTS</u></b></p> <ul style="list-style-type: none"> <li>○ Sediment</li> <li>● Nutrients &amp; Toxic Materials</li> <li>○ Oil &amp; Grease</li> <li>○ Floatable Materials</li> <li>● Other Construction Wastes</li> </ul>	<p style="text-align: center;"><b><u>IMPLEMENTATION CONSIDERATIONS</u></b></p> <ul style="list-style-type: none"> <li>○ Capital Costs</li> <li>● Maintenance</li> <li>● Training</li> <li>○ Suitability for Slopes &gt; 5%</li> </ul> <p><b>Other Considerations:</b></p> <ul style="list-style-type: none"> <li>● <i>Coordinate with concrete waste management</i></li> </ul>

### 4.2.1 Primary Use

Pavement sawcutting is performed on almost all construction projects that include removal or installation of pavement. Properly managing the slurry and cuttings from sawcutting prevents them from affecting surface and ground water resources.

### 4.2.2 Applications

Concrete sawcutting waste management is applicable on construction activities where sawcutting is part of the work, regardless of the size of the total area disturbed. It is also applicable on repair and maintenance projects that may not be required to implement erosion and sediment controls.

Concrete sawcutting waste management is based on the proper collection and disposal of the slurry and cuttings. Employee education is critical to ensuring correct procedures are followed.

### 4.2.3 Design Criteria

- Construction plan notes shall include proper concrete sawcutting waste management procedures.
- The contractor should be required to designate the site superintendent, foreman, or other person who is responsible for concrete sawcutting to also be responsible for concrete sawcutting waste management.

#### Slurry Collection

- During sawcutting operations, the slurry and cuttings shall be continuously vacuumed or otherwise recovered and not be allowed to discharge from the site.
- If the pavement to be cut is near a storm drain inlet, the inlet shall be blocked by sandbags or equivalent temporary measures to prevent the slurry from entering the inlet. Remove the sandbags immediately after completing sawcutting operations, so they do not cause drainage problems during storm events.
- The slurry and cuttings shall not be allowed to remain on the pavement to dry out.

#### Slurry Disposal

- Develop pre-determined, safe slurry disposal areas.
- Collected slurry and cuttings should be immediately hauled from the site for disposal at a waste facility. If this is not possible, the slurry and cuttings shall be discharged into onsite containment.
- The onsite containment may be an excavated or bermed pit lined with plastic that is a minimum of 10 millimeters thick. Refer to [Section 4.3 Concrete Waste Management](#) for additional design criteria and an example schematic. If the project includes placement of new concrete, slurry from sawcutting may be disposed of in facilities designated for the washout of concrete trucks instead constructing a separate containment.
- The containment shall be located a minimum of 50 feet away from inlets, swales, drainage ways, channels, and other waters, if the site configuration provides sufficient space to do so. In no case shall the collection area be closer than 20 feet from inlets, swales, drainage ways, channels and other waters.
- Several, portable, pre-fabricated, concrete washout, collection basins are commercially available and are an acceptable alternative to an onsite containment pit.
- Remove waste concrete when the containment is half full. Always maintain a minimum of one foot freeboard.

- Onsite evaporation of slurry water and recycling of the concrete waste is the preferred disposal method. When this is not feasible, discharge from the collection area shall only be allowed if a passive treatment system is used to remove the fines. Criteria are in [Section 3.7 Passive Treatment System](#). Mechanical mixing is required in the collection area. The pH must be tested, and discharge is allowed only if the pH does not exceed 8.0. The pH may be lowered by adding sulfuric acid to the slurry water. Dewatering of the collection area after treatment shall follow the criteria in [Section 3.3 Dewatering Controls](#).
- Care shall be exercised when treating the slurry water for discharge. Monitoring must be implemented to verify that discharges from the collection area do not violate groundwater or surface water quality standards.
- Geotextile fabrics such as those used for silt fence should not be used to control sawcutting waste, since the grain size is significantly smaller than the apparent opening size of the fabric.
- Use waste and recycling haulers and facilities approved by the local municipality.

### Education

- Supervisors must be made aware of the potential environmental consequences of improperly handling sawcutting slurry and waste.
- Train all workers performing sawcutting operations on the proper slurry and cuttings collection and disposal procedures.

#### 4.2.4 Design Guidance and Specifications

No specification for concrete sawcutting waste management is currently available in the Standard Specifications for Public Works Construction – North Central Texas Council of Governments.

#### 4.2.5 Inspection and Maintenance Requirements

Concrete sawcutting waste management measures should be inspected regularly (at least as often as required by the TPDES Construction General Permit). Project personnel should inspect the operations to assure that operators are diligent in controlling the water produced by the sawcutting activities. Pavement should be inspected each day after operations to ensure that waste removal has been adequately performed. Residual waste should be cleaned. Reinforce proper procedures with workers.

Inspect the collection area for signs of unauthorized discharges. Repair containment area as needed. Remove sediment and fines when the collection area volume is reduced by 50 percent.

### 4.3 Concrete Waste Management

**Waste Control**

**Description:** Concrete waste at construction sites comes in two forms: 1) excess fresh concrete mix, including residual mix washed from trucks and equipment, and 2) concrete dust and concrete debris resulting from demolition. Both forms have the potential to impact water quality through stormwater runoff contact with the waste. The objective of concrete waste management is to dispose of these wastes in a manner that protects surface and ground water.

<p style="text-align: center;"><b><u>KEY CONSIDERATIONS</u></b></p> <p><b>DESIGN CRITERIA:</b></p> <ul style="list-style-type: none"> <li>● Prohibit the discharge of untreated concrete washout water</li> <li>● Prohibit dumping waste concrete anywhere except at pre-determined, regulated, recycling or disposal sites</li> <li>● Provide a washout containment with a minimum of 6 cubic feet of containment volume for every 10 cubic yards of concrete placed</li> <li>● Minimum 1 foot freeboard on containment</li> <li>● Minimum 10 mil plastic lining of containment</li> <li>● Washout water evaporation and concrete recycling are the recommended disposal methods</li> <li>● Educate drivers and operators on proper disposal and equipment cleaning procedures</li> </ul> <p><b>LIMITATIONS:</b></p> <ul style="list-style-type: none"> <li>● Does not address concrete sawcutting waste</li> </ul> <p><b>MAINTENANCE REQUIREMENTS:</b></p> <ul style="list-style-type: none"> <li>● Inspect regularly</li> <li>● Check for and repair any damage to washout containment areas</li> <li>● Clean up any overflow of washout pits</li> <li>● Regularly remove and properly dispose of concrete waste</li> </ul>	<p style="text-align: center;"><b><u>APPLICATIONS</u></b></p> <p><b>Perimeter Control</b></p> <p><b>Slope Protection</b></p> <p><b>Sediment Barrier</b></p> <p><b>Channel Protection</b></p> <p><b>Temporary Stabilization</b></p> <p><b>Final Stabilization</b></p> <div style="border: 1px solid black; padding: 2px; text-align: center; margin: 5px 0;"><b>Waste Management</b></div> <p><b>Housekeeping Practices</b></p>
<p style="text-align: center;"><b><u>TARGETED POLLUTANTS</u></b></p> <ul style="list-style-type: none"> <li>○ Sediment</li> <li>● Nutrients &amp; Toxic Materials</li> <li>○ Oil &amp; Grease</li> <li>○ Floatable Materials</li> <li>● Other Construction Wastes</li> </ul>	<p style="text-align: center;"><b><u>IMPLEMENTATION CONSIDERATIONS</u></b></p> <ul style="list-style-type: none"> <li>○ Capital Costs</li> <li>○ Maintenance</li> <li>● Training</li> <li>○ Suitability for Slopes &gt; 5%</li> </ul> <p><b>Other Considerations:</b></p> <ul style="list-style-type: none"> <li>● <i>None</i></li> </ul>

### 4.3.1 Primary Use

Concrete waste management is used to prevent the discharge of concrete wash water and waste into stormwater runoff. A number of water quality parameters can be affected by the introduction of concrete, especially fresh concrete. Concrete affects the pH of runoff, causing significant chemical changes in water bodies and harming aquatic life. Suspended solids in the form of both cement and aggregated dust are also generated from both fresh and demolished concrete waste.

### 4.3.2 Applications

Concrete waste management is applicable to all construction sites where existing concrete is being demolished or new concrete is being placed, regardless of the size of the total area disturbed. It is also applicable on repair and maintenance projects that may not be required to implement erosion and sediment controls.

### 4.3.3 Design Criteria

- The discharge of washout water to an inlet, swale, or any portion of the storm drainage system or a natural drainage system (e.g. channel) shall be prohibited.
- Construction plan notes shall state that the discharge of concrete washout to anything except a designated containment area is prohibited.
- Show the location of the concrete washout containment on the drawings, or require the contractor to provide this information.
- The contractor should be required to designate the site superintendent, foreman, or other person who is responsible for concrete placement to also be responsible for concrete waste management.

### Unacceptable Waste Concrete Disposal Practices

- Dumping in vacant areas on the job-site.
- Illicit dumping onto off-site lots or any other placed not permitted to receive construction demolition debris.
- Dumping into ditches, drainage facilities, or natural water ways.
- Using concrete waste as fill material or bank stabilization.

### Recommended Disposal Procedures

- Identify pre-determined, regulated, facilities for disposal of solid concrete waste. Whenever possible, haul the concrete waste to a recycling facility. Disposal facilities must have a Class IV (or more stringent) municipal solid waste permit from the TCEQ.
- A concrete washout pit or other containment shall be installed a minimum of 50 feet away from inlets, swales, drainage ways, channels, and other waters, if the site configuration provides sufficient space to do so. In no case shall concrete washout occur closer than 20 feet from inlets, swales, drainage ways, channels and other waters.
- Provide a washout area with a minimum of 6 cubic feet of containment volume for every 10 cubic yards of concrete poured. Alternatively, the designer may provide calculations sizing the containment based on the number of concrete trucks and pumps to be washed out.
- The containment shall be lined with plastic (minimum 10 millimeters thick) or an equivalent measure to prevent seepage to groundwater.
- Mosquitoes do not typically breed in the high pH of concrete washout water. However, the concrete washout containment should be managed in a manner that prevents the collection of other water that could be a potential breeding habitat.

- Do not excavate the washout area until the day before the start of concrete placement to minimize the potential for collecting stormwater.
- Do not discharge any water or wastewater into the containment except for concrete washout to prevent dilution of the high pH environment that is hostile to mosquitoes.
- Remove the waste concrete and grade the containment closed within a week of completing concrete placement. Do not leave it open to collect stormwater.
- If water must be pumped from the containment, it shall be collected in a tank, neutralized to lower the pH, and then hauled to a treatment facility for disposal. Alternatively, it may be hauled to a batch plant that has an onsite collection facility for concrete washout water.
- Do **not** pump water directly from the containment to the Municipal Separate Storm Sewer System or a natural drainage way without treating for removal of fine particles and neutralization of the pH.
- Multiple concrete washout areas may be needed for larger projects to allow for drying time and proper disposal of the washout water and waste concrete.
- Portable, pre-fabricated, concrete washout containers are commercially available and are an acceptable alternative to excavating a washout area.
- Evaporation of the washout water and recycling of the concrete waste is the preferred disposal method. After the water has evaporated from the washout containment, the remaining cuttings and fine sediment shall be hauled from the site to a concrete recycling facility or a solid waste disposal facility.
- Remove waste concrete when the washout containment is half full. Always maintain a minimum of one foot freeboard.
- Use waste and recycling haulers and facilities approved by the local municipality.
- When evaporation of the washout water is not feasible, discharge from the collection area shall only be allowed if a passive treatment system is used to remove the fines. Criteria are in [Section 3.7 Passive Treatment System](#). Mechanical mixing is required within the containment for passive treatment to be effective. The pH must be tested, and discharge is allowed only if the pH does not exceed 8.0. The pH may be lowered by adding sulfuric acid to the water. Dewatering of the collection area after treatment shall follow the criteria in [Section 3.3 Dewatering Controls](#).
- Care shall be exercised when treating the concrete washout water for discharge. Monitoring must be implemented to verify that discharges do not violate groundwater or surface water quality standards.
- On large projects that are using a nearby batch plant, a washout facility associated with the plant and under the plant's TPDES Multi-Sector General Permit may be used instead of installing an onsite containment area for truck washout.

## Education

- Drivers and equipment operators should be instructed on proper disposal and equipment washing practices (see above).
- Supervisors must be made aware of the potential environmental consequences of improperly handled concrete waste.

## Enforcement

- The construction site manager or foreman must ensure that employees and pre-mix companies follow proper procedures for concrete disposal and equipment washing.
- Employees violating disposal or equipment cleaning directives must be re-educated or disciplined if necessary.

## Demolition Practices

- Monitor weather and wind direction to ensure concrete dust is not entering drainage structures and surface waters.
- Spray water on structures being demolished to wet them before start of demolition operations. Reapply water whenever dust is observed.
- Construct sediment traps or other types of sediment detention devices downstream of demolition activities to capture and treat runoff from demolition wetting operations.

### 4.3.4 *Design Guidance and Specifications*

No specification for concrete waste management is currently available in the Standard Specifications for Public Works – North Central Texas Council of Governemtns.

### 4.3.5 *Inspection and Maintenance Requirements*

Concrete waste management controls should be inspected regularly (at least as often as required by the TPDES Construction General Permit) for proper handling of concrete waste. Check concrete washout pits and make repairs as needed. Washout pits should not be allowed to overflow. Maintain a schedule to regularly remove concrete waste and prevent over-filling.

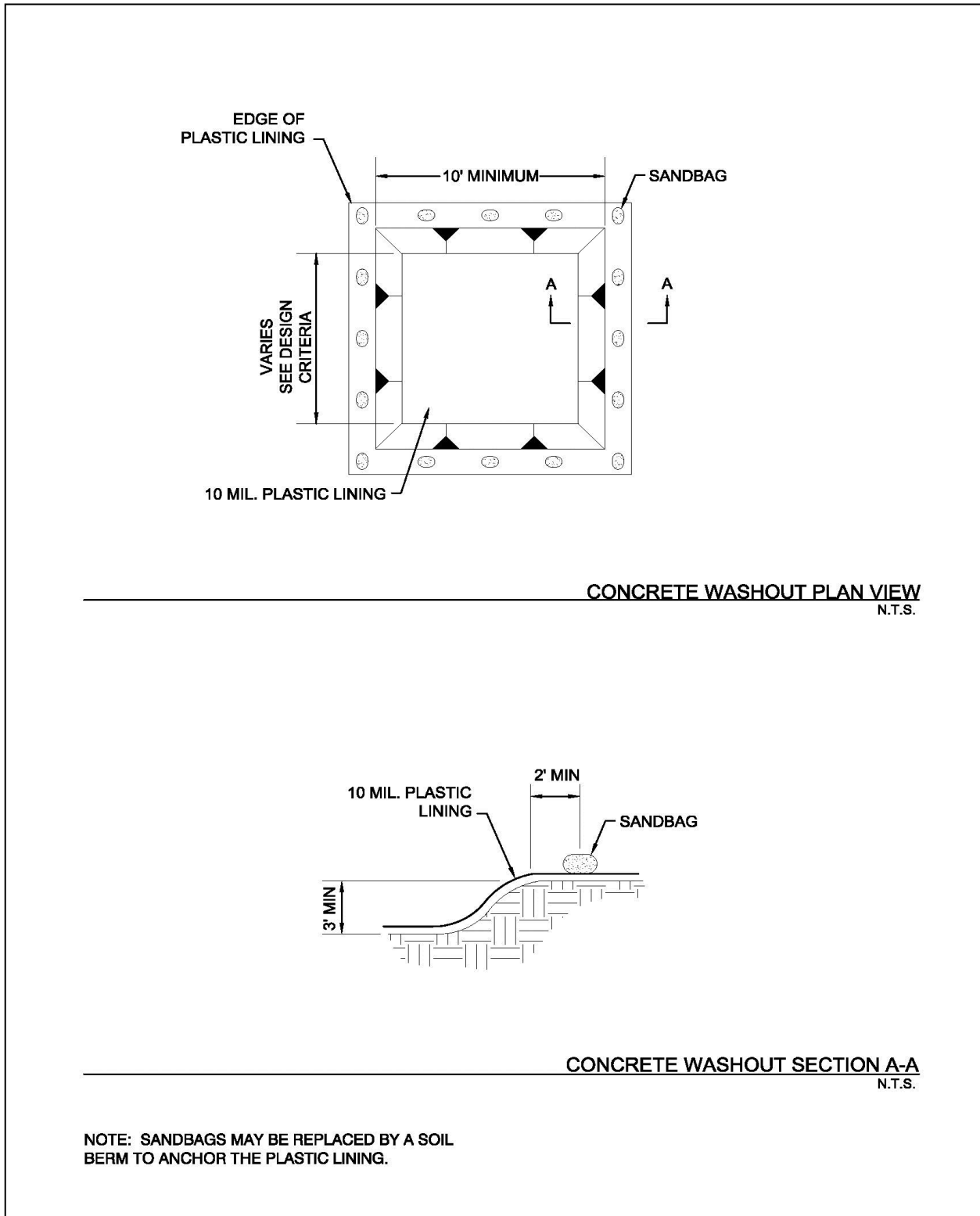
If illicit dumping of concrete is found, remove the waste and reinforce proper disposal methods through education of employees.

### 4.3.6 *Example Schematics*

The following schematics are example applications of the construction control. They are intended to assist in understanding the control's design and function.

The schematics are **not for construction**. They may serve as a starting point for creating a construction detail, but they must be site adapted by the designer. In addition, dimensions and notes appropriate for the application must be added by the designer.





**Figure 4.1 Schematics of Concrete Washout Containment**

## 4.4 Debris and Trash Management

### Waste Control

**Description:** Large volumes of debris and trash are often generated at construction sites, including packaging, pallets, wood waste, personal trash, scrap material, and a variety of other wastes. The objective of debris and trash management is to minimize the potential of stormwater contamination from solid waste through appropriate storage and disposal practices. Recycling of construction debris is encouraged to reduce the volume of material to be disposed of and associated costs of disposal.

<p style="text-align: center;"><b><u>KEY CONSIDERATIONS</u></b></p> <p><b>DESIGN CRITERIA:</b></p> <ul style="list-style-type: none"> <li>● Implement a job-site waste handling and disposal education and awareness program</li> <li>● Provide sufficient and appropriate waste storage containers</li> <li>● Provide timely removal of stored solid waste materials</li> <li>● Train workers and monitor compliance</li> </ul> <p><b>LIMITATIONS:</b></p> <ul style="list-style-type: none"> <li>● Only addresses non-hazardous solid waste</li> <li>● One part of a comprehensive construction site waste management program</li> </ul> <p><b>MAINTENANCE REQUIREMENTS:</b></p> <ul style="list-style-type: none"> <li>● Inspect regularly</li> <li>● Empty waste containers regularly</li> <li>● Clean up loose trash and debris daily</li> <li>● Verify procedures are being followed</li> <li>● Train new employees and regularly re-train all employees</li> </ul>	<p style="text-align: center;"><b><u>APPLICATIONS</u></b></p> <p><b>Perimeter Control</b></p> <p><b>Slope Protection</b></p> <p><b>Sediment Barrier</b></p> <p><b>Channel Protection</b></p> <p><b>Temporary Stabilization</b></p> <p><b>Final Stabilization</b></p> <div style="border: 1px solid black; padding: 2px; margin: 5px 0;"> <p><b>Waste Management</b></p> </div> <div style="border: 1px solid black; padding: 2px; margin: 5px 0;"> <p><b>Housekeeping Practices</b></p> </div>
<p style="text-align: center;"><b><u>TARGETED POLLUTANTS</u></b></p> <ul style="list-style-type: none"> <li>○ Sediment</li> <li>● Nutrients &amp; Toxic Materials</li> <li>○ Oil &amp; Grease</li> <li>● Floatable Materials</li> <li>● Other Construction Wastes</li> </ul>	<p style="text-align: center;"><b><u>IMPLEMENTATION CONSIDERATIONS</u></b></p> <ul style="list-style-type: none"> <li>● Capital Costs</li> <li>● Maintenance</li> <li>● Training</li> <li>○ Suitability for Slopes &gt; 5%</li> </ul> <p><b>Other Considerations:</b></p> <ul style="list-style-type: none"> <li>● <i>None</i></li> </ul>

### 4.4.1 Primary Use

Debris and trash management is used to minimize floatables and other wastes in stormwater. By controlling the trash and debris onsite, stormwater quality is improved and the need for extensive clean up upon completion of the project is reduced.

### 4.4.2 Applications

Debris and trash management is applicable on all construction sites where workers are present. Even if the only construction activity is earthwork, workers will still have drink bottles, lunch bags, and other wastes that must be managed.

Solid waste management for construction sites is based on proper storage and disposal practices by construction workers and supervisors. Key elements of the program are education and modification of improper disposal habits. Cooperation and vigilance is required on the part of supervisors and workers to ensure that the procedures are followed.

The following are lists describing the type of targeted materials.

- Construction (and Demolition) Debris:
  - Dimensional lumber
  - Miscellaneous wood (pallets, plywood, etc)
  - Copper (pipe and electrical wiring)
  - Miscellaneous metal (studs, pipe, conduit, sheathing, nails, etc)
  - Insulation
  - Brick and mortar
  - Shingles
  - Roofing materials
  - Gypsum board
- Trash:
  - Paper and cardboard (packaging, containers, wrappers)
  - Plastic (packaging, bottles, containers)
  - Styrofoam (cups, packing, and forms)
  - Food and beverage containers
  - Food waste

### 4.4.3 Design Criteria

- Construction plan notes shall include proper debris and trash management procedures.
- Show the location of waste storage containers on the drawings, or require the contractor to add this information.
- The contractor should be required to designate a site superintendent, foreman, safety officer, or other senior person who is onsite daily to be responsible for implementing debris and trash management.

### Storage Procedures

- All waste sources and storage areas shall be located a minimum of 50 feet away from inlets, swales, drainage ways, channels and other waters, if the site configuration provides sufficient space to do so.

In no case shall material and waste sources be closer than 20 feet from inlets, swales, drainage ways, channels, and other waters.

- Construction waste and trash shall be stored in a manner that minimizes its exposure to precipitation and stormwater runoff.
- Whenever possible, minimize production of debris and trash.
- Instruct construction workers in proper debris and trash storage and handling procedures.
- Segregate potentially hazardous waste from non-hazardous construction site debris. Hazardous waste shall be managed according to the criteria in *Section 4.1 Chemical Management*.
- Segregate recyclable or re-usable construction debris from other waste materials. A goal of re-using or recycling 50 percent of the construction debris and waste is recommended.
- Keep debris and trash under cover in either a closed dumpster or other enclosed trash container that limits contact with rain and runoff and prevents light materials from blowing out.
- Check the municipality's storage requirements. Some municipalities have specific requirements for the size and type of waste containers for construction sites.
- Do not allow trash containers to overflow. Do not allow waste materials to accumulate on the ground.
- Prohibit littering by workers and visitors.
- Police site daily for litter and debris.
- Enforce solid waste handling and storage procedures.

### **Disposal Procedures**

- If feasible, recycle construction and demolition debris such as wood, metal, and concrete.
- Trash and debris shall be removed from the site at regular intervals that are scheduled to empty containers when they are 90 percent full or more frequently.
- General construction debris may be hauled to a licensed construction debris landfill (typically less expensive than a sanitary landfill).
- Use waste and recycling haulers/facilities approved by the local municipality.
- No waste, trash, or debris shall be buried, burned or otherwise disposed of onsite.
- Cleared trees and brush may be burned if authorized by the municipality and proper permits are obtained from the county and/or TCEQ. Chipping of trees and brush for use as mulch is the preferred alternative to burning or offsite disposal.

### **Education**

- Educate all workers on solid waste storage and disposal procedures.
- Instruct workers in identification of solid waste and hazardous waste.
- Have regular meetings to discuss and reinforce disposal procedures (incorporate in regular safety seminars).
- Clearly mark on all debris and trash containers which materials are acceptable.

### **Quality Control**

- Foreman and/or construction supervisor shall monitor onsite solid waste storage and disposal procedures.
- Check the site, particularly areas frequented by workers during lunch and breaks, for loose trash and debris and the end of each work day.

- Discipline workers who repeatedly violate procedures.

#### *4.4.4 Design Guidance and Specifications*

No specification for debris and trash management measures is found currently available in the Standard Specifications for Public Works Construction – North Central Texas Council of Governments.

#### *4.4.5 Inspection and Maintenance Requirements*

Debris and trash management measures should be inspected regularly (at least as often as required by the TPDES Construction General Permit). If waste containers are overflowing, call the waste hauler immediately for a pick-up. If loose trash and debris are found around the site, reinforce proper waste management procedures through education of workers.

Construction sites must maintain separate waste containers clearly marked for non-hazardous, hazardous and recyclable waste. Check solid waste containers for chemical, special, or hazardous wastes that are improperly placed in them. These wastes shall be removed and handled according to criteria in *Section 4.1 Chemical Management*.

The site should be checked for loose litter and debris at the end of each working day.

## 4.5 Hyper-Chlorinated Water Management

### Waste Control

**Description:** Hyper-chlorinated water is routinely used to disinfect new waterlines and appurtenances. Chlorine protects humans from pathogens in water, but it is toxic to aquatic ecosystems. The objective of hyper-chlorinated water management is to discharge the water in a manner that protects surface water and related aquatic ecosystems.

<p style="text-align: center;"><b><u>KEY CONSIDERATIONS</u></b></p> <p><b>DESIGN CRITERIA:</b></p> <ul style="list-style-type: none"> <li>• Educate employees on proper procedures</li> <li>• Discharge to sanitary sewer if the system operator approves</li> <li>• Discharge water onsite for natural chlorine attenuation</li> <li>• Use appropriate dosage for chemical de-chlorination based on chemical used and chlorine concentration</li> <li>• Chlorine concentration must be less than 4 ppm before leaving the site</li> <li>• Use velocity dissipation devices for discharges</li> <li>• Always monitor receiving waters for negative effects</li> </ul> <p><b>LIMITATIONS:</b></p> <ul style="list-style-type: none"> <li>• Discharge to sanitary sewer limited by sewer capacity</li> <li>• Discharges limited to areas without vegetation that is to be preserved</li> <li>• Wet, cool, and overcast days limits chlorine attenuation and removal</li> </ul> <p><b>MAINTENANCE REQUIREMENTS:</b></p> <ul style="list-style-type: none"> <li>• Monitor continuously during discharge</li> <li>• Check for and repair any erosion caused by discharge</li> <li>• Sample and test receiving water hourly for chlorine</li> </ul>	<p style="text-align: center;"><b><u>APPLICATIONS</u></b></p> <p><b>Perimeter Control</b></p> <p><b>Slope Protection</b></p> <p><b>Sediment Barrier</b></p> <p><b>Channel Protection</b></p> <p><b>Temporary Stabilization</b></p> <p><b>Final Stabilization</b></p> <div style="border: 1px solid black; padding: 2px; text-align: center;"><b>Waste Management</b></div> <p><b>Housekeeping Practices</b></p>
<p style="text-align: center;"><b><u>TARGETED POLLUTANTS</u></b></p> <ul style="list-style-type: none"> <li><input type="radio"/> Sediment</li> <li><input checked="" type="radio"/> Nutrients &amp; Toxic Materials</li> <li><input type="radio"/> Oil &amp; Grease</li> <li><input type="radio"/> Floatable Materials</li> <li><input type="radio"/> Other Construction Wastes</li> </ul>	<p style="text-align: center;"><b><u>IMPLEMENTATION CONSIDERATIONS</u></b></p> <ul style="list-style-type: none"> <li><input type="radio"/> Capital Costs</li> <li><input type="radio"/> Maintenance</li> <li><input checked="" type="radio"/> Training</li> <li><input type="radio"/> Suitability for Slopes &gt; 5%</li> </ul> <p><b>Other Considerations:</b></p> <ul style="list-style-type: none"> <li>• None</li> </ul>

### 4.5.1 Primary Use

Hyper-chlorinated water is used to disinfect new water lines.

### 4.5.2 Applications

Construction sites that install new water lines or repair or replace existing water lines should use hyper-chlorinated water management measures.

### 4.5.3 Design Criteria

- Drawing notes shall include procedures for the proper discharge of hyper-chlorinated water from waterline disinfection.
- The contractor should be required to designate the site superintendent, foreman, or other person who is responsible for water line disinfection to also be responsible for hyper-chlorinated water management.
- Educate employees about the environmental hazards of high chlorine concentrations and the proper procedures for handling hyper-chlorinated water.
- Hyper-chlorinated water shall not be discharged to the environment unless the chlorine concentration is reduced to 4 ppm or less by chemically treating to dechlorinate or by onsite retention until natural attenuation occurs.
- Water with a measurable chlorine concentration of less than 4 ppm is considered potable and an authorized discharge; however, large volumes of water with chlorine at this concentration can still be toxic to aquatic ecosystems. Do not discharge water that has been de-chlorinated to 4 ppm directly to surface water. It shall be discharged onto vegetation or through a conveyance system for further attenuation of the chlorine before it reaches surface water.
- Discharges of high flow rate and velocities shall be directed to velocity dissipation devices.

### Discharge to Sanitary Sewers

- The preferred method of disposal for hyper-chlorinated water is discharge into a sanitary sewer system.
- Permission from the sanitary sewer operator **must** be obtained to discharge to the sanitary sewer.
- Limitations on discharges to the sanitary sewer are the capacity of the sanitary sewer and the availability of a sewer manhole near the construction site.
- The designer shall verify that the sanitary sewer is capable of receiving the flow rate that will result from dewatering the disinfected line within the required time.
- Consideration should be given to timing the discharge with the daily low flow period for the sanitary sewer system.

### Onsite Discharge

- Hyper-chlorinated water may be applied to the construction site if it can be done without causing a discharge. The feasibility of this option is dependent on the volume of water, the size of the construction site, and the conditions of the site. Site application should not be done when the soil moisture content is high due to recent storm events.
- Chlorine can burn vegetation, so it should not be used to water vegetation that is being used for stabilization, vegetated filters or buffers, or other vegetation to be preserved.
- Hyper-chlorinated water may be discharged to an onsite retention area until natural attenuation occurs. The area may be a dry stormwater retention basin, or a portion of the site may be graded to form a temporary pit or bermed area.

- Natural attenuation of the chlorine may be aided by aeration. Air can be added to the water by directing the discharge over a rough surface (e.g. riprap) before it enters the temporary retention area or an aeration device (e.g. circulation pump) can be placed in the retention area.
- Onsite discharge may require several hours to a few days before the water is safe to discharge. The rate at which chlorine will attenuate is affected by soil conditions and weather conditions. Attenuation will occur quickest during warm, sunny, dry periods.
- If the hyper-chlorinated water is retained in a pit or basin, and then pumped to discharge, pumping shall follow the criteria in [Section 3.3 Dewatering Controls](#).

## Chemical Dechlorination

- If non-chemical means of dechlorination are not feasible, chemical methods may be used to neutralize the chlorine before discharging the hyper-chlorinated water.
- Vitamin C in the form of ascorbic acid or sodium ascorbate is the preferred dechlorination agent.
- Consider the National Fire Protection Association (NFPA) rating when selecting a dechlorination chemical. The NFPA rating is given by a series of three numbers ranging from 0 to 4, with 0 being no risk and 4 the highest risk. The sequence of numbers rank the health hazard, flammability risk and reactivity risk of the chemical. A NFPA rating of 0,0,0 indicates no risk for all three categories.
- Ensure appropriate personal protective equipment (PPE) is specified for workers depending on the chemical being used to neutralize the chlorine.
- The chemicals listed in Table 4.1 may be used to neutralize chlorine.

<b>Dechlorinating Agent</b>	<b>Dosing Rate (parts Agent : parts Chlorine)</b>	<b>Advantages</b>	<b>Disadvantages</b>
Ascorbic Acid (form of Vitamin C)	2.5:1	<ul style="list-style-type: none"> <li>• Not toxic to aquatic species</li> <li>• Quick reaction time</li> <li>• NFPA rating of 0,0,0</li> </ul>	<ul style="list-style-type: none"> <li>• May lower pH in receiving water</li> </ul>
Sodium Ascorbate (form of Vitamin C)	2.8:1	<ul style="list-style-type: none"> <li>• Does not affect pH</li> <li>• Not toxic to aquatic species</li> <li>• Quick reaction time</li> <li>• NFPA rating of 0,0,0</li> </ul>	<ul style="list-style-type: none"> <li>• Greater amount needed than Ascorbic Acid</li> <li>• More expensive</li> </ul>
Sodium Thiosulfate	2:1 to 7:1 depending on pH	<ul style="list-style-type: none"> <li>• Less expensive</li> <li>• Readily available</li> <li>• Long history of use (familiarity)</li> </ul>	<ul style="list-style-type: none"> <li>• Must calculate dosage based on pH</li> <li>• Skin, eye, nose and throat irritant</li> <li>• Consumes oxygen in water</li> <li>• May encourage bacterial growth in receiving streams</li> </ul>
Calcium Thiosulfate	1:1 to 0.5:1 depending on pH	<ul style="list-style-type: none"> <li>• Less expensive</li> <li>• Not toxic to aquatic species</li> <li>• NFPA rating of 0,0,0</li> </ul>	<ul style="list-style-type: none"> <li>• Must calculate dosage based on pH</li> <li>• Over-dosing produces suspended solids</li> <li>• Over-dosing may increase turbidity in receiving water</li> <li>• May encourage bacterial growth in receiving streams</li> </ul>

- The designer shall confirm dosages with the chemical supplier before using the dechlorination agent.



- Chlorine and residual agent concentrations and the pH of the discharged water shall be monitored at least hourly using field tests.
- The treated water should be discharged onto pavement or into a dry conveyance system to allow aeration and reaction time before the dechlorinated water reaches the receiving water. The receiving water should be closely monitored for any signs of negative effects from the discharge.

#### *4.5.4 Design Guidance and Specifications*

No specification for hyper-chlorinated water management is currently available in the Standard Specifications for Public Works Construction – North Central Texas Council of Governments.

#### *4.5.5 Inspection and Maintenance Requirements*

Hyper-chlorinated water management measures should be monitored continuously while the hyper-chlorinated water is being discharged. Discharges to a sanitary sewer should be monitored for back-ups or overflows that indicate the discharge is exceeding the sewer's capacity. If these occur, the rate of discharge must be decreased or another discharge method is needed.

Onsite or chemically treated discharge should be monitored for chlorine and residual chemical concentrations. Verify that discharges are not causing erosion, and modify the discharge to use velocity dissipation devices if erosion is occurring. Repair any eroded areas. If water is being pumped from a temporary retention area, verify that appropriate dewatering controls are in place.

For all discharges, frequently inspect the receiving water for any evidence of negative effects. Sample and test the receiving water hourly for chlorine. Stop the discharge immediately if chlorine is detected and modify the discharge procedures before resuming.

## 4.6 Sandblasting Waste Management

### Waste Control

**Description:** The objective of sandblasting waste management is to minimize the potential of stormwater quality degradation from sandblasting activities at construction sites. The key issues in this program are prudent handling and storage of sandblast media, dust suppression, and proper collection and disposal of spent media. It is not the intent of this control to outline all of the worker safety issues pertinent to this practice. Safety issues should be addressed by construction safety programs as well as local, state, and federal regulations.

<p style="text-align: center;"><b><u>KEY CONSIDERATIONS</u></b></p> <p><b>DESIGN CRITERIA:</b></p> <ul style="list-style-type: none"> <li>● Prohibit discharge of sandblasting waste</li> <li>● Provide site specific fugitive dust control and containment equipment</li> <li>● Educate employees on proper procedures</li> <li>● Provide proper sandblast equipment for the job</li> <li>● Ensure compliance by supervisors and workers</li> </ul> <p><b>LIMITATIONS:</b></p> <ul style="list-style-type: none"> <li>● Does not address hazardous materials that may be present in the waste</li> <li>● Does not address spill and leak response procedures</li> </ul> <p><b>MAINTENANCE REQUIREMENTS:</b></p> <ul style="list-style-type: none"> <li>● Inspect regularly</li> <li>● Contain and dispose of sandblast grit</li> <li>● Train new employees and regularly re-train all employees</li> </ul>	<p style="text-align: center;"><b><u>APPLICATIONS</u></b></p> <p><b>Perimeter Control</b></p> <p><b>Slope Protection</b></p> <p><b>Sediment Barrier</b></p> <p><b>Channel Protection</b></p> <p><b>Temporary Stabilization</b></p> <p><b>Final Stabilization</b></p> <div style="border: 1px solid black; padding: 2px; display: inline-block;"><b>Waste Management</b></div> <p><b>Housekeeping Practices</b></p>
<p style="text-align: center;"><b><u>TARGETED POLLUTANTS</u></b></p> <ul style="list-style-type: none"> <li>○ Sediment</li> <li>● Nutrients &amp; Toxic Materials</li> <li>○ Oil &amp; Grease</li> <li>○ Floatable Materials</li> <li>● Other Construction Wastes</li> </ul>	<p style="text-align: center;"><b><u>IMPLEMENTATION CONSIDERATIONS</u></b></p> <ul style="list-style-type: none"> <li>● Capital Costs</li> <li>● Maintenance</li> <li>● Training</li> <li>○ Suitability for Slopes &gt; 5%</li> </ul> <p><b>Other Considerations:</b></p> <ul style="list-style-type: none"> <li>● <i>OSHA requirements</i></li> <li>● <i>Special procedures for sandblasting operations on structures known to contain hazardous materials</i></li> <li>● <i>Possible site assessment or remediation required if hazardous materials present</i></li> </ul>

### 4.6.1 Primary Use

Sandblasting is typically used to clean a surface or prepare a surface for coatings. Since the sandblasting media consists of fine abrasive granules, it can be easily transported by running water. Sandblasting activities typically create a significant dust problem that must be contained and collected to prevent off-site migration of fines. Particular attention must be paid to sandblasting work on bridges, box culverts, and head walls that span or are immediately adjacent to streams and waterways.

### 4.6.2 Applications

This control should be implemented when sandblasting operations will occur on a construction site.

If a discharge of sandblasting waste occurs, it shall be considered a spill and handled according to the criteria in *Section 4.8 Spill and Leak Response Procedures*.

### 4.6.3 Design Criteria

- Construction plan notes shall include proper sandblasting waste management procedures.
- The contractor should be required to designate the site superintendent, foreman, or other person who is responsible for sandblasting to also be responsible for sandblasting waste management.
- Prohibit the discharge of sandblasting waste.

### Operational Procedures

- Use only inert, non-degradable sandblast media.
- Use appropriate equipment for the job; do not over-blast.
- Wherever possible, blast in a downward direction.
- Install a windsock or other wind direction instrument.
- Cease blasting activities in high winds or if wind direction could transport grit to drainage facilities.
- Install dust shielding around sandblasting areas.
- Collect and dispose of all spent sandblast grit, use dust containment fabrics and dust collection hoppers and barrels.
- Non-hazardous sandblast grit may be disposed in permitted construction debris landfills or permitted sanitary landfills.
- If sandblast media cannot be fully contained, construct sediment traps downstream from blasting area where appropriate.
- Use sand fencing where appropriate in areas where blast media cannot be fully contained.
- If necessary, install misting equipment to remove sandblast grit from the air prevent runoff from misting operations from entering drainage systems.
- Use vacuum grit collection systems where possible.
- Keep records of sandblasting materials, procedures, and weather conditions on a daily basis.
- Take all reasonable precautions to ensure that sandblasting grit is contained and kept away from drainage structures.

### Educational Issues

- Educate all onsite employees of potential dangers to humans and the environment from sandblast grit.

- Instruct all onsite employees of the potential hazardous nature of sandblast grit and the possible symptoms of over-exposure to sandblast grit.
- Instruct operators of sandblasting equipment on safety procedures and personal protection equipment.
- Instruct operators on proper procedures regarding storage, handling and containment of sandblast grit.
- Instruct operators and supervisors on current local, state and federal regulations regarding fugitive dust and hazardous waste from sandblast grit.
- Have weekly meetings with operators to discuss and reinforce proper operational procedures.
- Establish a continuing education program to indoctrinate new employees.

### **Materials Handling Recommendations**

- Sandblast media should always be stored under cover away from drainage structures.
- Ensure that stored media or grit is not subject to transport by wind.
- Ensure that all sandblasting equipment and storage containers comply with current local, state and federal regulations.
- Refer to [Section 4.1 Chemical Management](#) if sandblast grit is known or suspected to contain hazardous components.
- Capture and treat runoff, which comes into contact with sandblasting material or waste.

### **Quality Assurance**

- Foreman and/or construction supervisor should monitor all sandblasting activities and safety procedures.
- Educate and if necessary, discipline workers who violate procedures.
- Take all reasonable precautions to ensure that sandblast grit is not transported off-site or into drainage facilities.

#### ***4.6.4 Design Guidance and Specifications***

No specification for sandblasting waste management is currently available in the Standard Specifications for Public Works Construction – North Central Texas Council of Governments.

#### ***4.6.5 Inspection and Maintenance Requirements***

Sandblasting waste management measures should be inspected regularly (at least as often as required by the TPDES Construction General Permit). Verify that sandblasting grit is contained and disposed of properly. Check for downstream locations and the off-site perimeter for evidence of discharges or off-site transport by wind.

Check that daily records of sandblasting activities are current. Hold weekly meetings with operators to reinforce proper procedures. Regularly re-educate employees on potential dangers and hazards, safety procedures and proper handling.

## 4.7 Sanitary Waste Management

### Waste Control

**Description:** The objective of sanitary waste management is to provide for collection and disposal of sanitary waste in a manner that minimizes the exposure to precipitation and stormwater. This is most often accomplished by providing portable facilities for construction site workers.

#### KEY CONSIDERATIONS

##### DESIGN CRITERIA:

- Provide sanitary facilities at the rate of one toilet per 10 workers for a 40-50 hour work week
- Locate portable toilets a minimum of 50 feet away from storm drain inlets, conveyance channels or surface waters
- If unable to meet the 50 foot requirement, locate portable toilets at least 20 feet away and provide secondary containment
- Show location of portable toilets on the drawings
- Have a plan to clean up spills

##### LIMITATIONS:

- Multiple facilities and/or facilities in several locations may be needed to adequately serve a construction site
- Facilities are subject to vandalism if not within a secured construction site

##### MAINTENANCE REQUIREMENTS:

- Inspect regularly
- Check for proper servicing, leaks and spills
- Service toilets at the frequency recommended by the supplier

#### TARGETED POLLUTANTS

- Sediment
- Nutrients & Toxic Materials
- Oil & Grease
- Floatable Materials
- Other Construction Wastes

#### APPLICATIONS

- Perimeter Control
- Slope Protection
- Sediment Barrier
- Channel Protection
- Temporary Stabilization
- Final Stabilization

Waste Management
------------------

Housekeeping Practices
------------------------

#### IMPLEMENTATION CONSIDERATIONS

- Capital Costs
- Maintenance
- Training
- Suitability for Slopes > 5%

##### Other Considerations:

- *None*

### 4.7.1 *Primary Use*

Sanitary facilities are used to properly store and dispose of sanitary wastes that are generated onsite.

### 4.7.2 *Applications*

Sanitary facilities should be available to workers at all construction sites. If permanent facilities are not available, portable toilets are placed at the construction site.

### 4.7.3 *Design Criteria*

- Construction plan notes shall include requirements for the contractor to provide an appropriate number of portable toilets based on the number of employees using the toilets and the hours they will work. The typical standard is one portable toilet per 10 workers for a 40-50 hour work week.
- The location of portable toilets shall be shown on the drawings.
- Sanitary facilities shall be placed a minimum of 50 feet away from storm drain inlets, conveyance channels or surface waters. If unable to meet the 50 foot requirement due to site configuration, portable toilets shall be a minimum of 20 feet away from storm drain inlets, conveyance channels or surface waters and secondary containment shall be provided in case of spills.
- The location of the portable toilets shall be accessible to maintenance trucks without damaging erosion and sediment controls or causing erosion or tracking problems.
- Sanitary facilities shall be fully enclosed and designed in a manner that minimizes the exposure of sanitary waste to precipitation and stormwater runoff.
- When high winds are expected, portable toilets shall be anchored or otherwise secured to prevent them from being blown over.
- The company that supplies and maintains the portable toilets shall be notified immediately if a toilet is tipped over or damaged in a way that results in a discharge. Discharged solid matter shall be vacuumed into the septic truck by the company that maintains the toilets. A solution of 10 parts water to 1 parts bleach shall be applied to all ground surfaces contaminated by liquids from the toilet.
- The operator of the municipal separate storm sewer system (MS4) shall be notified if a discharge from the portable toilets enters the MS4 or a natural channel.

### 4.7.4 *Design Guidance and Specifications*

No specification for sanitary facilities is currently available in the Standard Specifications for Public Works Construction – North Central Texas Council of Governments.

### 4.7.5 *Inspection and Maintenance Requirements*

Sanitary facilities should be inspected regularly (at least as often as required by the TPDES Construction General Permit) for proper servicing, leaks and spills. Portable toilets shall be regularly serviced at the frequency recommended by the supplier for the number of people using the facility.

## 4.8 Spill and Leak Response Procedures

### Waste Control

**Description:** Spill and leak response procedures address the management of spills and leaks that may occur at the construction site. The objective of the spill and leak response procedures is to minimize the discharge of pollutants from unplanned releases of chemicals, fuel, motor vehicle fluids, hazardous materials or wastes through appropriate recognition and response procedures.

<p style="text-align: center;"><b><u>KEY CONSIDERATIONS</u></b></p> <p><b>DESIGN CRITERIA:</b></p> <ul style="list-style-type: none"> <li>• Develop procedures based on the Material Safety and Data Sheets for substances onsite</li> <li>• Maintain spill kits for petroleum products and other chemicals frequently onsite</li> <li>• Post emergency contact numbers</li> <li>• Designate a spill response coordinator</li> <li>• Train employees</li> <li>• Review reporting requirements for onsite chemicals</li> </ul> <p><b>LIMITATIONS:</b></p> <ul style="list-style-type: none"> <li>• Procedures susceptible to being forgotten because they are seldom or never used</li> <li>• Larger spills and spills of extremely hazardous materials require special equipment and should be handled by professionals</li> <li>• Not applicable to long-term contamination remediation</li> </ul> <p><b>MAINTENANCE REQUIREMENTS:</b></p> <ul style="list-style-type: none"> <li>• Review procedures regularly</li> <li>• Verify spill kits, MSDSs, and emergency contacts are readily available</li> <li>• Train new employees and regularly re-train all employees</li> </ul>	<p style="text-align: center;"><b><u>APPLICATIONS</u></b></p> <p><b>Perimeter Control</b></p> <p><b>Slope Protection</b></p> <p><b>Sediment Barrier</b></p> <p><b>Channel Protection</b></p> <p><b>Temporary Stabilization</b></p> <p><b>Final Stabilization</b></p> <div style="border: 1px solid black; padding: 2px; text-align: center;"><b>Waste Management</b></div> <p><b>Housekeeping Practices</b></p>
<p style="text-align: center;"><b><u>TARGETED POLLUTANTS</u></b></p> <ul style="list-style-type: none"> <li>○ Sediment</li> <li>● Nutrients &amp; Toxic Materials</li> <li>● Oil &amp; Grease</li> <li>○ Floatable Materials</li> <li>● Other Construction Wastes</li> </ul>	<p style="text-align: center;"><b><u>IMPLEMENTATION CONSIDERATIONS</u></b></p> <ul style="list-style-type: none"> <li>● Capital Costs</li> <li>● Maintenance</li> <li>● Training</li> <li>○ Suitability for Slopes &gt; 5%</li> </ul> <p><b>Other Considerations:</b></p> <ul style="list-style-type: none"> <li>• <i>OSHA, EPA and TCEQ regulations</i></li> </ul>

### 4.8.1 Primary Use

Spill and leak procedures are used to minimize the impact of accidental releases on surface water. Pollutants that are of concern for spill and leaks include chemicals, hazardous materials, fuel, motor vehicle fluids, washout waters, and wastes. Spill and leak response is a secondary control. Proper procedures for managing these pollutants should be the primary control and are the best way to prevent the need for spill and leak response.

### 4.8.2 Applications

Spill and leak response procedures are applicable on all construction sites where chemicals, hazardous materials, fuels, etc. are stored or used. They are most important when the construction site is adjacent or near to a floodplain, wetland, stream, or other waters.

### 4.8.3 Design Criteria

#### General

- An effective spill and leak response depends on proper recognition and response practices by construction workers and supervisors. Key elements are education and training.
- Records of releases that exceed the Reportable Quantity (RQ) for oil and hazardous substances should be maintained in accordance with the Federal and State regulations.
- Emergency contact information and spill response procedures shall be posted in a readily available area for access by all employees and subcontractors.
- Spill containment kits should be maintained for petroleum products and other chemicals that are regularly onsite. Materials in kits should be based on containment guidelines in the Material Safety and Data Sheets (MSDSs) for the substance most frequently onsite.
- Spill kits are intended for response to small spills, typically less than 5 gallons, of substances that are not extremely hazardous.
- Significant spills or other releases warrant immediate response by trained professionals.
- Suspected job-site contamination should be immediately reported to regulatory authorities and protective actions taken.

#### Coordinator

- The contractor should be required to designate a site superintendent, foreman, safety officer, or other senior person who is onsite daily to be the Spill and Leak Response Coordinator.
- The coordinator must have knowledge of and be trained in correct spill and leak response procedures.
- The coordinator shall be responsible for implementing the spill and leak procedures and training all employees and sub-contractors on the site-specific spill and leak procedures. The training should include their responsibility to immediately notify the coordinator if a spill or leak occurs.

#### Spill Response

- Upon discovery of a spill, employees and subcontractors shall implement the following procedures:
  - Immediately stop work and clear the area by moving upwind of the spill.
  - Remove all ignition sources.
  - Notify the Spill and Leak Response Coordinator.
  - If there is an immediate danger to health or life, contact 911.



- The Spill and Leak Response Coordinator shall perform the following when the spill is not immediately dangerous to health and safety:
  - Consult the MSDS for safety and response procedures.
  - If it can be done safely, use onsite spill kits and soil to contain the spill.
  - Notify a hazardous response company to remove and properly dispose of the spilled material and the contaminated containment materials.

## Spill Reporting

- The Spill and Leak Response Coordinator is responsible for notifying authorities of spills and leaks. Notification requirements are based on Reportable Quantities as established by the type or material, quantity and location (onto land or into water in the state) of the release.
- Reportable Quantities (RQ) in the State of Texas are established by the TCEQ in Texas Administrative Code Title 30, Chapter 327 (30 TAC 327) Spill Prevention and Control.
- The Texas RQ for petroleum products and used oil is 25 gallons released onto land or any amount that causes sheen on water.
- Reportable Quantities for all other substances are listed in 30 TAC 327.4, which references the EPA List of Lists (EPA 550-B-01-003) available at: <http://www.epa.gov/ceppo/pubs/title3.pdf>
- The Spill and Leak Response Coordinator shall notify the following:
  - The municipality that operates the local Municipal Separate Storm Sewer System (MS4) if a spill or leak enters public rights-of-way or any type of drainage way or drainage infrastructure within the jurisdiction of the municipality.
  - State of Texas Spill Report Hotline at 1-800-832-8224 if the spill or leak exceeds the RQ; and during regular business hours, the TCEQ Dallas/Fort Worth Regional Office at 817-588-5800.
  - National Spill Response Center at 1-800-424-8802 if the spill or leak exceeds the RQ.

### 4.8.4 Design Guidance and Specifications

National guidance for response procedures are established by the Environmental Protection Agency (EPA) in the Code of Federal Regulations (CFR). Specific sections addressing spills are governed by:

- 40 CFR Part 68 Chemical Accident Prevention Provisions.
- 40 CFR Part 302 Designation, Reportable Quantities (RQ) and Notification.
- 40 CFR Part 355 Emergency Planning and Notification.

Guidance for emergency response procedures in the State of Texas are established by the Texas Commission on Environmental Quality (TCEQ) in the Texas Administrative Code Title 30, Chapter 327, Spill Prevention and Control.

No specification for construction of this item is currently available in the Standard Specifications for Public Works Construction – North Central Texas Council of Governments.

### 4.8.5 Inspection and Maintenance Requirements

Spill and leak response measures should be inspected regularly (at least as often as required by the TPDES Construction General Permit). Verify that spill containment materials are available for small spills. Also verify that emergency contact information is posted. These phone numbers and Material Safety and Data Sheets should be in a location that is readily accessible to workers.

If procedures are lacking, reinforce requirements by re-training employees.

## 4.9 Subgrade Stabilization Management

### Material Control

**Description:** Lime and other chemicals are used extensively in the North Central Texas region to stabilize pavement subgrades for roadways, parking lots, and other paved surfaces, and as a subgrade amendment for building pad sites. These chemicals are applied to the soil and mixed through disking and other techniques, and then allowed to cure. The objective of subgrade stabilization management is to reduce the potential for runoff to carry the chemicals offsite, where they may impact aquatic life in streams, ponds, and other water bodies.

<p style="text-align: center;"><b><u>KEY CONSIDERATIONS</u></b></p> <p><b>DESIGN CRITERIA:</b></p> <ul style="list-style-type: none"> <li>• Educate employees on proper procedures</li> <li>• Include procedural controls in stabilization specifications</li> <li>• Limit stabilization operations to that which can be thoroughly mixed and compacted by the end of each workday</li> <li>• Prohibit vehicle traffic, other than water trucks and mixing equipment, from passing over the area being stabilized until mixing is completed</li> <li>• Avoid applications when there is a significant probability of rain that will produce runoff</li> <li>• Roughen areas adjacent and downstream of stabilized areas to intercept lime from runoff</li> <li>• Provide secondary containment according to <a href="#">Section 4.1 Chemical Management</a> for stabilizers stored onsite</li> </ul> <p><b>LIMITATIONS:</b></p> <ul style="list-style-type: none"> <li>• Prevention of contamination is only effective method</li> <li>• Does not address spill response when discharge occurs</li> </ul> <p><b>MAINTENANCE REQUIREMENTS:</b></p> <ul style="list-style-type: none"> <li>• Inspect down slope perimeters and outfalls regularly during stabilization operations</li> <li>• Immediately halt operations if a discharge is found and modify procedures to prevent future discharges</li> </ul>	<p style="text-align: center;"><b><u>APPLICATIONS</u></b></p> <p><b>Perimeter Control</b></p> <p><b>Slope Protection</b></p> <p><b>Sediment Barrier</b></p> <p><b>Channel Protection</b></p> <p><b>Temporary Stabilization</b></p> <p><b>Final Stabilization</b></p> <p><b>Waste Management</b></p> <div style="border: 1px solid black; padding: 2px; text-align: center;"><b>Housekeeping Practices</b></div>
<p style="text-align: center;"><b><u>TARGETED POLLUTANTS</u></b></p> <ul style="list-style-type: none"> <li>○ Sediment</li> <li>● Nutrients &amp; Toxic Materials</li> <li>○ Oil &amp; Grease</li> <li>○ Floatable Materials</li> <li>○ Other Construction Wastes</li> </ul>	<p style="text-align: center;"><b><u>IMPLEMENTATION CONSIDERATIONS</u></b></p> <ul style="list-style-type: none"> <li>○ Capital Costs</li> <li>● Maintenance</li> <li>● Training</li> <li>○ Suitability for Slopes &gt; 5%</li> </ul> <p><b>Other Considerations:</b></p> <ul style="list-style-type: none"> <li>• <i>Chemical management controls for onsite storage of stabilization chemicals</i></li> </ul>

### 4.9.1 Primary Use

This measure should be implemented when chemicals are required for soil stabilization. Lime is the most commonly used for stabilization and is considered a chemical. Other agents may also be used for subgrade stabilization depending on the soil and site conditions.

### 4.9.2 Applications

Chemical stabilization can be used under a variety of conditions. The engineer should determine the applicability of chemical stabilization based on site conditions such as available open space, quantity of area to be stabilized, proximity of nearby water courses and other measures employed at the site. The use of diversion dikes and interceptor swales (see appropriate sections) to divert runoff away from areas to be stabilized can be used in conjunction with these techniques to reduce the potential impact of discharges from chemical stabilization.

Management of stabilization chemicals is based on implementing procedures to prevent a discharge. If a discharge occurs, it shall be considered a spill and handled according to the criteria in [Section 4.8 Spill and Leak Response Procedures](#).

### 4.9.3 Design Criteria

- Construction plan notes or stabilization shall include procedural controls to minimize the discharge of chemical stabilizers.
- The contractor shall limit the amount of stabilizing agent onsite to that which can be thoroughly mixed and compacted by the end of each workday.
- Stabilizers shall be applied at rates that result in no runoff.
- Stabilization shall not occur immediately before and during rainfall events.
- No traffic other than water trucks and mixing equipment shall be allowed to pass over the area being stabilized until after completion of mixing the chemical.
- Areas adjacent and downstream of stabilized areas shall be roughened to intercept chemical runoff and reduce runoff velocity.
- Geotextile fabrics such as those used for silt fence should not be used to treat chemical runoff, because the chemicals are dissolved in the water and won't be affected by a barrier and the suspended solids are significantly smaller than the apparent opening size of the fabric.
- For areas in which phasing of chemical stabilization is impractical, a curing seal (such as Liquid Asphalt, Grace MC-250, or MC-800) applied at a rate of 0.15 gallons per square yard of surface can be used to protect the base.
- Use of sediment basins with a significant (>36 hour) drawdown time is encouraged to capture any accidental lime or chemical overflows when large areas are being stabilized ([Section 3.9 Sediment Basin](#)).
- Provide containment around chemical storage, loading and dispensing areas.
- If soil stabilizers are stored onsite, they shall be considered hazardous material and shall be managed according to the criteria in [Section 4.1 Chemical Management](#) to capture any accidental lime or chemical overflow.

### 4.9.4 Design Guidance and Specifications

No specification for subgrade stabilization management is currently available in the Standard Specifications for Public Works Construction – North Central Texas Council of Governments.

### 4.9.5 Inspection and Maintenance Requirements

Subgrade stabilization operation should be observed frequently as the operations proceed for evidence of discharges. Inspect the down slope perimeter and all outfalls for evidence of discharges. Pay particularly attention to the outfall of drainage pipes connected to inlets within the area being stabilized. If a discharge is found, immediately halt stabilization operations until additional controls can be implemented.

### 4.9.6 Example Schematic

The following schematic is an example application of the construction control. It is intended to assist in understanding the control's design and function.

The schematic is **not for construction**. It may serve as a starting point for creating a construction detail, but it must be site adapted by the designer. In addition, dimensions and notes appropriate for the application must be added by the designer.

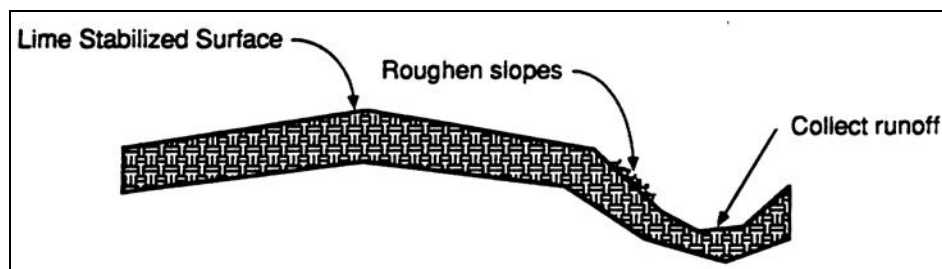


Figure 4.2 Schematic of Controls for Subgrade Stabilization

## 4.10 Vehicle and Equipment Management

**Material and Waste Control**

**Description:** Vehicle and equipment management addresses the practices associated with proper use and maintenance of vehicles and equipment at construction sites. The objective is to minimize the discharge of pollutants from vehicle and equipment operation, fueling, maintenance, and washing.

<p style="text-align: center;"><b><u>KEY CONSIDERATIONS</u></b></p> <p><b>DESIGN CRITERIA:</b></p> <ul style="list-style-type: none"> <li>• Prohibit the discharge of maintenance fluids and wash water with soap</li> <li>• If feasible, prohibit onsite vehicle washing</li> <li>• If feasible, prohibit onsite maintenance except fueling</li> <li>• Provide secondary containment that's 110 percent of the largest container in the containment</li> <li>• Use spill/overflow devices for fueling</li> <li>• Never leave a fueling operation unattended</li> <li>• Label all waste containers</li> <li>• Train workers in proper procedures</li> </ul> <p><b>LIMITATIONS:</b></p> <ul style="list-style-type: none"> <li>• Cost of maintenance, repairs, and spill prevention equipment</li> <li>• One part of a comprehensive construction site waste management program</li> <li>• Does not address spill and leak response procedures</li> </ul> <p><b>MAINTENANCE REQUIREMENTS:</b></p> <ul style="list-style-type: none"> <li>• Inspect regularly</li> <li>• Check for signs of leaks and spills and take corrective actions</li> <li>• Place drip pans under leaking vehicles and equipment when parked</li> <li>• Verify procedures are being followed</li> <li>• Train new employees and regularly re-train all employees</li> </ul>	<p style="text-align: center;"><b><u>APPLICATIONS</u></b></p> <p><b>Perimeter Control</b></p> <p><b>Slope Protection</b></p> <p><b>Sediment Barrier</b></p> <p><b>Channel Protection</b></p> <p><b>Temporary Stabilization</b></p> <p><b>Final Stabilization</b></p> <div style="border: 1px solid black; padding: 2px; margin: 2px 0;"> <p><b>Waste Management</b></p> </div> <div style="border: 1px solid black; padding: 2px; margin: 2px 0;"> <p><b>Housekeeping Practices</b></p> </div>
<p style="text-align: center;"><b><u>TARGETED POLLUTANTS</u></b></p> <ul style="list-style-type: none"> <li><input type="radio"/> Sediment</li> <li><input checked="" type="radio"/> Nutrients &amp; Toxic Materials</li> <li><input checked="" type="radio"/> Oil &amp; Grease</li> <li><input type="radio"/> Floatable Materials</li> <li><input checked="" type="radio"/> Other Construction Wastes</li> </ul>	<p style="text-align: center;"><b><u>IMPLEMENTATION CONSIDERATIONS</u></b></p> <ul style="list-style-type: none"> <li><input type="radio"/> Capital Costs</li> <li><input type="radio"/> Maintenance</li> <li><input checked="" type="radio"/> Training</li> <li><input type="radio"/> Suitability for Slopes &gt; 5%</li> </ul> <p><b>Other Considerations:</b></p> <ul style="list-style-type: none"> <li>• <i>None</i></li> </ul>

### 4.10.1 Primary Use

Vehicle and equipment management is used to minimize the pollutants that enter stormwater from fueling and maintenance activities.

### 4.10.2 Applications

Vehicle and equipment management is applicable on every construction site. The management controls are most effective when used in conjunction with controls in [Section 4.8 Spill and Leak Response Procedures](#).

The management techniques are based on proper recognition and handling of pollutant sources related to vehicles and equipment. Key elements are education, established procedures, and provisions for safe storage and disposal of wastes. The following list (not all inclusive) gives examples of the targeted materials:

- Fuels
- Lube Oils
- Antifreeze
- Solvents
- Wash water

### 4.10.3 Design Criteria

- Construction plan notes shall state that the discharge of fuels, oils, or other pollutants used in vehicle and equipment operation and maintenance is prohibited.
- Construction plan notes shall state that the discharge of soaps or solvents used in vehicle and equipment washing is prohibited.
- On the construction plans, show the location of fuel tanks, motor vehicle fluids storage, and waste storage, including secondary containment, or require the contractor to provide this information.
- Provide secondary containment for fuel, new and waste oil, and other maintenance fluids that are stored onsite. Secondary containment shall have a minimum volume of 110 percent of the largest container within the containment.
- Criteria for the response to spills of motor vehicle fluids are in [Section 4.8 Spill and Leak Response Procedures](#).
- The contractor should be required to designate a site superintendent, foreman, safety officer, or other senior person, who is on the site daily, to be responsible for implementing vehicle and equipment management.

### Vehicle Washing

- Minimize the potential for the discharge of pollutants from equipment and vehicle washing by prohibiting these activities onsite, if practical. Vehicles and equipment should be transported to a commercial vehicle wash facility with appropriate discharge controls.
- Designate a wash area if vehicle and equipment washing must be done onsite. Require all washing to be done at this location. The area shall be graded so that all wash water flows to a sediment basin or other sediment control that provides equivalent or better treatment.
- Do not use soap for vehicle and equipment washing. Sediment controls will not remove soap from the wash water.

- Vehicle and equipment wash water may contain oils, greases, and heavy metals. Treatment to remove these pollutants is needed in addition to sediment trapping. Any wash water that has sheen on it must be considered polluted and cannot be discharged from the site without appropriate treatment. State or local discharge permits may be required.

## Maintenance

- If possible, prohibit onsite maintenance except for fueling. Otherwise, limit onsite maintenance to routine preventive maintenance.
- Maintenance fluids should be stored in appropriate containers (closed drums or similar) and under cover.
- The ground under vehicles and equipment parked onsite should be inspected for drips and leaks before each use. Drip pans should be placed under parked vehicles and equipment that leak or drip.
- Vehicles and equipment that leak or drip should be removed from the site for repair as soon as possible.
- Vehicles and equipment that become inoperative should be removed from the site for repairs.

## Fueling

- Check the municipality's requirements for fuel tanks. Some municipalities have specific requirements for the type of tank and secondary containment. At a minimum, local fire codes apply.
- Fuel should be dispensed using a drip pan or other spill/overflow device or within containment berms or other secondary containment.
- If the containment control is an earthen pit or berm, the containment shall be lined with plastic.
- If an automatic pump is used for fueling, it should be equipped with an overfill protection device.
- Workers performing fueling operations shall be trained in the correct procedures for fueling and spill response.
- Workers performing fueling operations shall be present and observe the fueling at all times. Fueling shall not be left unattended.
- A spill containment kit shall be maintained within 25 feet of the fueling area.

## Waste Handling and Disposal

- Ensure that adequate waste storage volume is available.
- All waste containers shall be clearly labeled.
- Handling and disposal of waste from vehicle and equipment maintenance should be according to the criteria in [Section 4.1 Chemical Management](#).

## Education

- Instruct workers on procedures for washing, maintaining, and fueling vehicles and equipment.
- Instruct workers in identification of pollutants associated with vehicles and equipment.
- Have regular meetings to discuss and reinforce procedures (incorporate into regular safety briefings).
- Establish a continuing education program to train new employees.

### 4.10.4 Design Guidance and Specifications

No specification for vehicle and equipment management is currently available in the Standard Specifications for Public Works Construction – North Central Texas Council of Governments.

#### *4.10.5 Inspection and Maintenance Requirements*

Vehicle and equipment management controls should be inspected regularly (at least as often as required by the TPDES Construction General Permit). Verify that washing, fueling, storage, and disposal procedures are being followed. Correct workers where needed.

Fueling and maintenance fluid storage areas should be checked for signs of leakage or spills. If evidence is found, corrective actions should be implemented. Reinforce proper procedures through re-education of employees. Inspect areas where vehicles and equipment are parked for signs of leaks. Use drip pans where needed.